

GATES
RADIO
APPARATUS



GATES RADIO CO.
QUINCY, ILL., U.S.A.

GATES TRANSMITTING EQUIPMENT ALL OVER THE WORLD

INTRODUCTION AND A WORD ABOUT THE GATES RADIO COMPANY

The Company from whom you buy your broadcasting equipment is important to you. We know if you will read these few lines about us we will both become better acquainted. We want to know you and we in turn want you to know us.

Gates Radio Company was founded in 1922 by Henry C. and Cora B. Gates. It is, at this writing, celebrating its 25th year of doing business; the large part of which has been with radio broadcasting stations around the world. Our Company has always been located in Quincy, Illinois, which is a moderate sized city of a little over 40,000 population, located on the Mississippi River 135 miles north of St. Louis and 265 miles west of Chicago. Quincy is located on the Kansas City Division of the Chicago, Burlington and Quincy Railroad with fast streamliner service and numerous daily diesel powered, high speed freight trains leaving each day in the four directions. Quincy also has one of the largest airports in the United States known as class 4 in size.

Financially we invite your checking us in Dun & Bradstreet or through your bank. Gates has never failed to discount an invoice in its 25 years of doing business.

As people we are perhaps just like you. We belong to Rotary or one of the other service clubs, we bowl each Monday night; Gates has an average team as far as bowlers go but super average as far as men are concerned. We worry if things go wrong and a tingle goes up our spine when we land a good order. There are men of nearly all religious beliefs at Gates and most of them go to some Church on Sunday. The President of Gates weighs 225 pounds as does the chief engineer, while the executive vice president watches his diet with good New England tenacity and the sales manager doesn't care and doesn't change.

The janitor is as welcome at the Gates factory as any one else. Actually there are no brass hats or underdogs. We are in business for profit, but a moderate profit. What profits there are go to two places; either expansion to make more and better jobs, or to our fellow workers who build Gates equipment. We have 55,000 feet of floor space divided into four buildings, all adjoining, modern, sprinklered and well kept. The space is all devoted to making radio transmitting equipment, nothing else.

What does this mean to you? Simply this: though much larger, we are quite like the corner grocery store; you may contact us either in person or by letter, wire or phone, and talk to whom you please. Chances are you might find any of several executives testing a transmitter or helping load a shipment on a trailer. We like radio and that's why we are in the business and we aim to make equipment as fine as is made. In short, our engineers know their business. Every person has the knowledge that material in our factory makes us nothing, but in your hands makes both of us a profit. If you need a ten cent whatsit we will spend a ten dollar phone call to get it if need be.

Or to add all of the above into a few short lines, there is more in transmitters than coils, dials and knobs. Value received is not only in well-engineered and substantially built equipment; but added to this is the desire for your continued friendship, and each of us will strive to satisfy so that when we do meet you for the first time we both may know that we have worked together.

L. I. McEWEN,
Executive Vice President.

1922 —



— 1947

GATES RADIO COMPANY
MANUFACTURERS, ENGINEERS, SINCE 1922
QUINCY, ILLINOIS, U.S.A.

GATES

TRANSMITTING EQUIPMENT

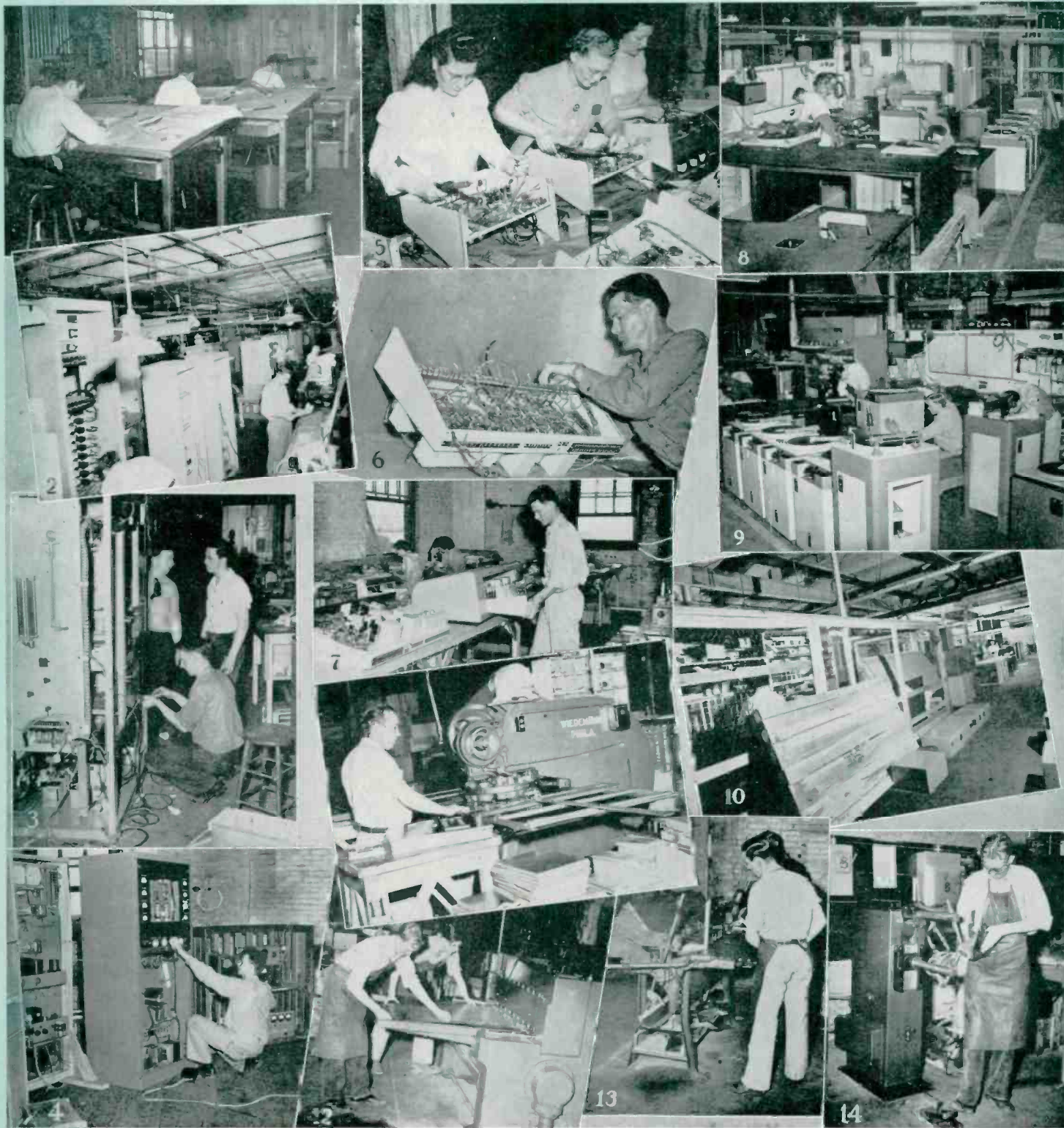

1 — Planning.
 2 — On the Line.
 3 — Button D Up.
 4 — Test.
 5 — Feminine Touch.

6 — Tedious.
 7 — Nearly Ready.
 8 — Transcribed.
 9 — Rub Down.
 10 — Stock.

11 — Turret Punching.
 12 — Little Ones Out of 31x Ones.
 13 — Shaping.
 14 — A Spot.

GATES RADIO COMPANY
 MANUFACTURERS, ENGINEERS, SINCE 1922
 QUINCY, ILLINOIS, U.S.A.

THE "CUSTOMAIRE" 250-WATT BROADCAST TRANSMITTER

Model BC-250D

LONG HAS IT BEEN OUR DESIRE TO
give to 250 watt broadcasting stations something
that was unusual in design, appearance and re-
liability but more important, a transmitter about
which we could truthfully say, money was no
factor in its design. In fact, Gates engineers
were told to build a transmitter that had every-
thing; one they would build for themselves if
they were handed a blank check, so to speak.
As a result they have come up with a truly great
transmitter, a little more in cost than any other
transmitter on the market but the best 250 watt
transmitter ever made for a radio broadcasting
station.

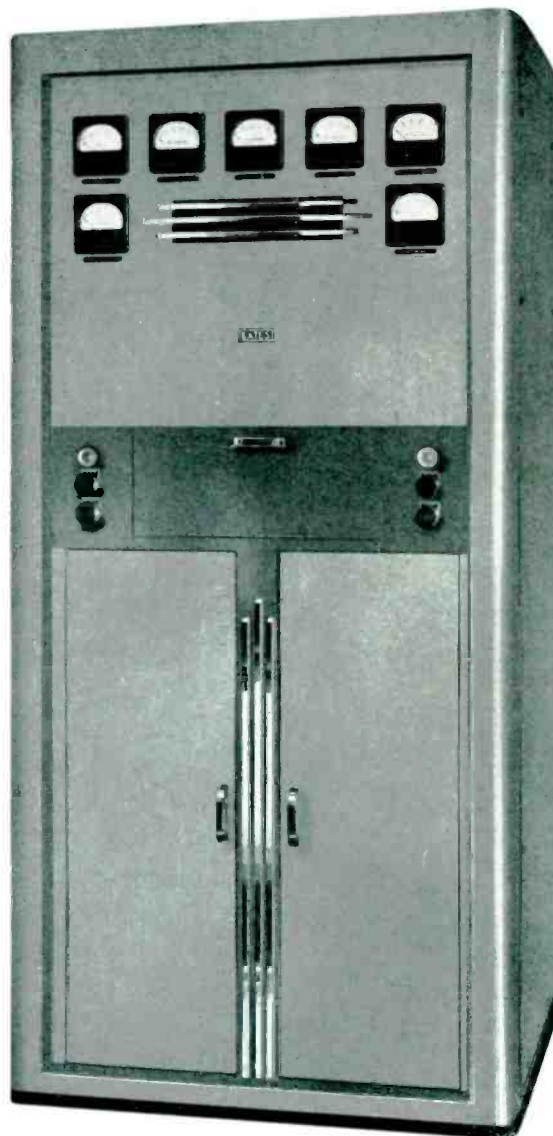

TRANSMITTING EQUIPMENT

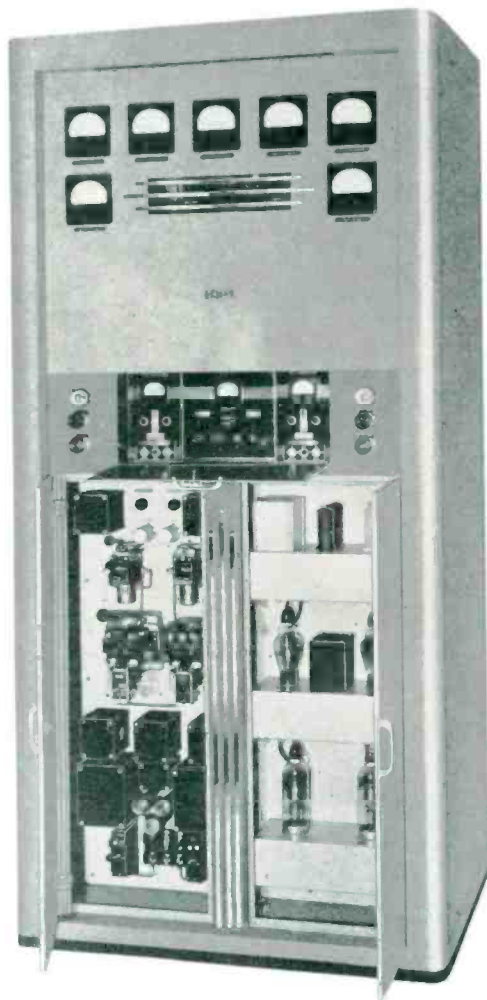

THE APPLICATION OF THIS TRANSMITTER . . .
 is in 250 watt stations that want extra dependability in equipment, rugged design and the most pleasing appearance. These attributes have been obtained by selecting the most popular features obtained from comments of hundreds of station owners, managers and engineers. Consequently, the customairster has been practically designed by and for the broadcast industry.

When the doors are opened on the front of the BC-250D the frequency control units, control circuits, rectifier and low level audio stages are all in plain view and readily accessible. Push buttons for application of plate and filament voltages are on either side of the frequency control units. Note the seven four-inch meters at the top for metering the major circuits.

Both side panels can be removed for inspection of components. The view to the right shows the left side of the BC-250D.



THERE ARE THREE MAJOR FEATURES EXTRA . . .
 on the "Customairster" that will not be found on any other 250 watt equipment. They are: (1) complete overall constant voltage regulation regardless of line voltage between 190 and 250 volts. By "overall" is meant filament, bias and plate voltages. So com-



GATES RADIO COMPANY
 MANUFACTURERS, ENGINEERS, SINCE 1922
 QUINCY, ILLINOIS, U.S.A.

TRANSMITTING EQUIPMENT

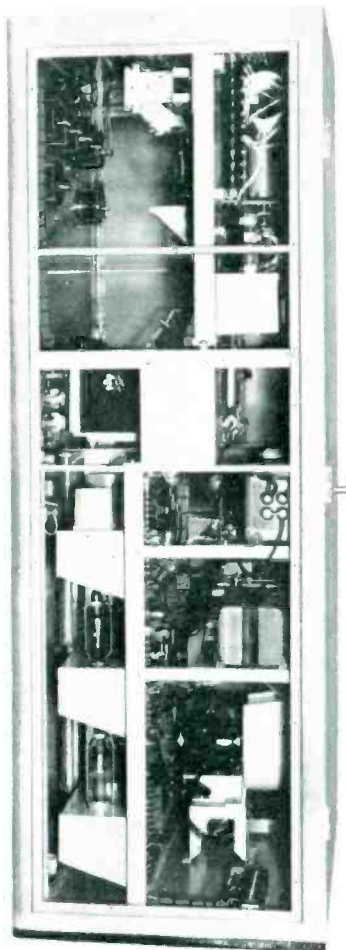
plete is this constant voltage perfection that neither filament nor plate rheostats are needed: (2) dual oscillator-buffer units on "plug-in" "slide-out" shelves for immediate servicing. This means not only dual crystals but dual ovens, dual oscillator tubes, dual first buffer

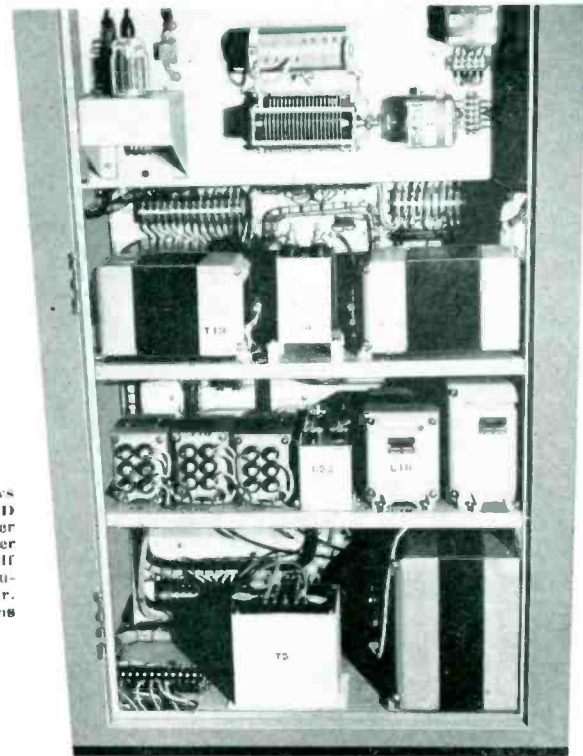

This shows the right side of the transmitter with the side panel removed. It is seldom necessary to remove either side panel as the front and back doors allow ample servicing room.



The rear view to the right shows the lower half of the BC-250D transmitter. The main power transformer is in the lower right corner. On the third shelf from the bottom are the modulation transformer and rectifier. All are of generous proportions to insure long life.

tubes, dual metering and dual parts throughout. In case of any failure in this most critical portion of the transmitter equipment just switch over to the other unit, pull out the troublesome one, make repairs and replace; (3) the use of high voltage at low current, approximately 2000 volts is applied on the RF final amplifier and 2150 volts on the class B modulators. Though this obviously requires greater insulation it means lower currents which spells better regulation, cool operation and greater reliability.

THERE ARE A HOST OF OTHER EXTRAS TOO . . .
 not usually found on other transmitters because cost does not allow them. A few are: (a) forced air ventilation in a semi-

GATES RADIO COMPANY
 MANUFACTURERS, ENGINEERS, SINCE 1922
 QUINCY, ILLINOIS, U.S.A.

GATES

TRANSMITTING EQUIPMENT

At the right is a close-up of the frequency control unit section. One control unit is shown partially removed. On the center panels are the tuning controls for the entire transmitter. The center switch selects either control unit, the left switch designates which circuit is being tuned and the right switch shows direction of the adjustment being made. The meter indicates grid current to the 813 exciter stage.

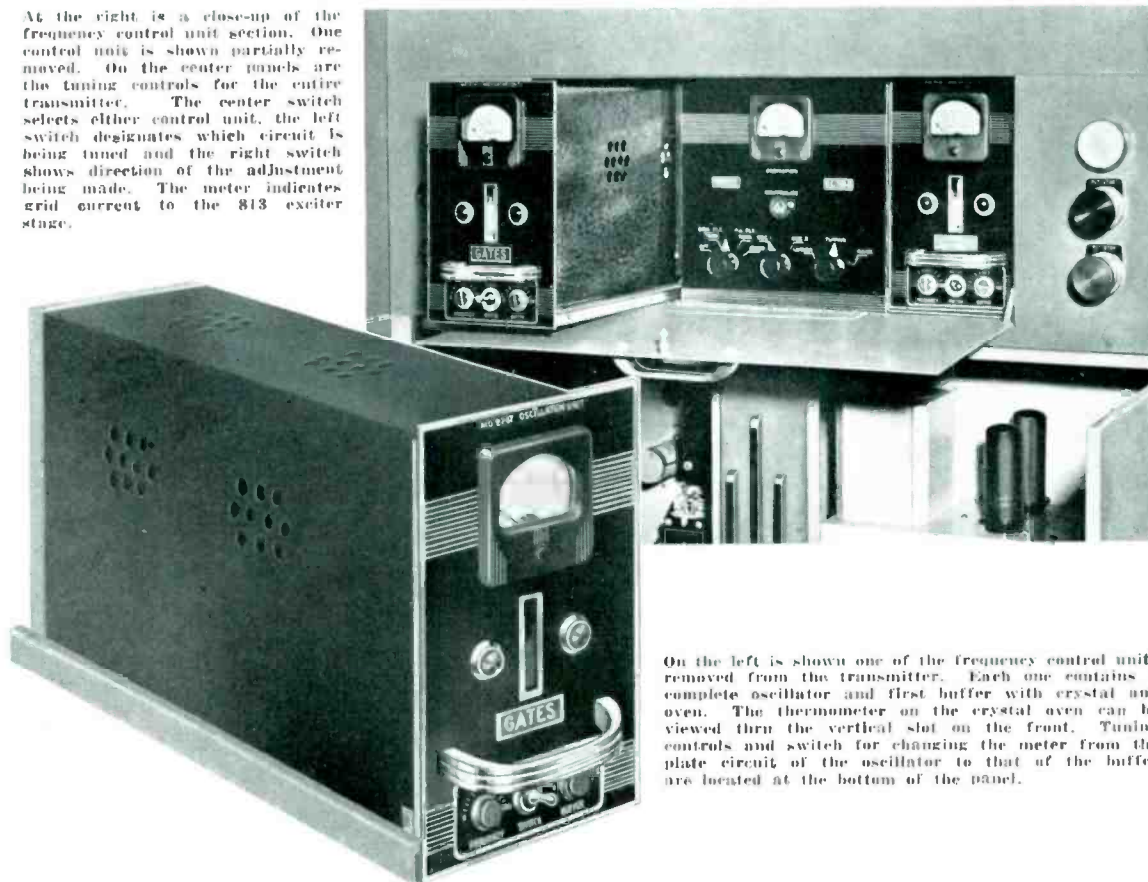

On the left is shown one of the frequency control units removed from the transmitter. Each one contains a complete oscillator and first buffer with crystal and oven. The thermometer on the crystal oven can be viewed thru the vertical slot on the front. Tuning controls and switch for changing the meter from the plate circuit of the oscillator to that of the buffer are located at the bottom of the panel.

pressure type cabinet that is insect and dust-free. Air is forced continually through the transmitter by means of a generously proportioned blower; (b) spun glass air filters in back and top assure low dirt content around all working parts; (c) the use of motor tuning with new low speed motors and planetary drives actually making possible split line tuning; (d) many separate power supplies, including a selenium bias supply to divide the load and provide

reliability; (e) maximum harmonic suppression and simplicity of loading adjustments by reason of the antenna coupling system employed; (f) larger, more rugged, and likewise more complete relay complement for absolute protection of all components; (g) 100% accessibility with three front doors, full size back door, removable side panels and vertical inside construction; (h) use of 4 inch meters in all major circuits.

GATES RADIO COMPANY
 MANUFACTURERS, ENGINEERS, SINCE 1922
 QUINCY, ILLINOIS, U.S.A.

GATES

TRANSMITTING EQUIPMENT

THE RF CIRCUIT....

consists of four radio frequency stages. A 6V6 oscillator, 807 first intermediate stage, 813 second intermediate stage and a 250th final power amplifier (806 in place of 250th if desired) forms the radio frequency complement. Each stage uses circuits of proved worth that are easy to adjust.

THE AUDIO FUNDAMENTALS....

are such that approximately plus 6 VU easily

drives the transmitter to 100% modulation. A pair of 1622 tubes in push pull drive the class B-710 modulators. Overall inverse feed back is employed reducing harmonic distortion and noise to extremely low limits. The high plate voltage on the modulators current is so low that the difference under normal operation between static and dynamic modulator currents is about 75 Ma. meaning negligible carrier shift, better regulation and very low distortion.

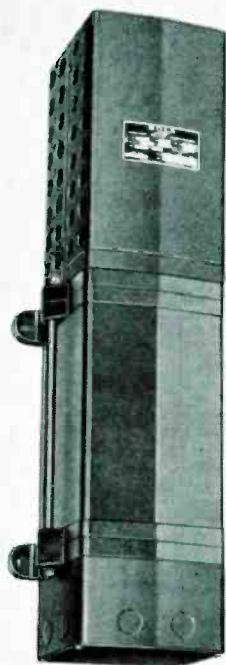

This is the constant voltage transformer supplied as part of the BC-250D. It assures excellent regulation even over wide variations of the supply voltage—your insurance that no interruptions will take place from severe line fluctuations.

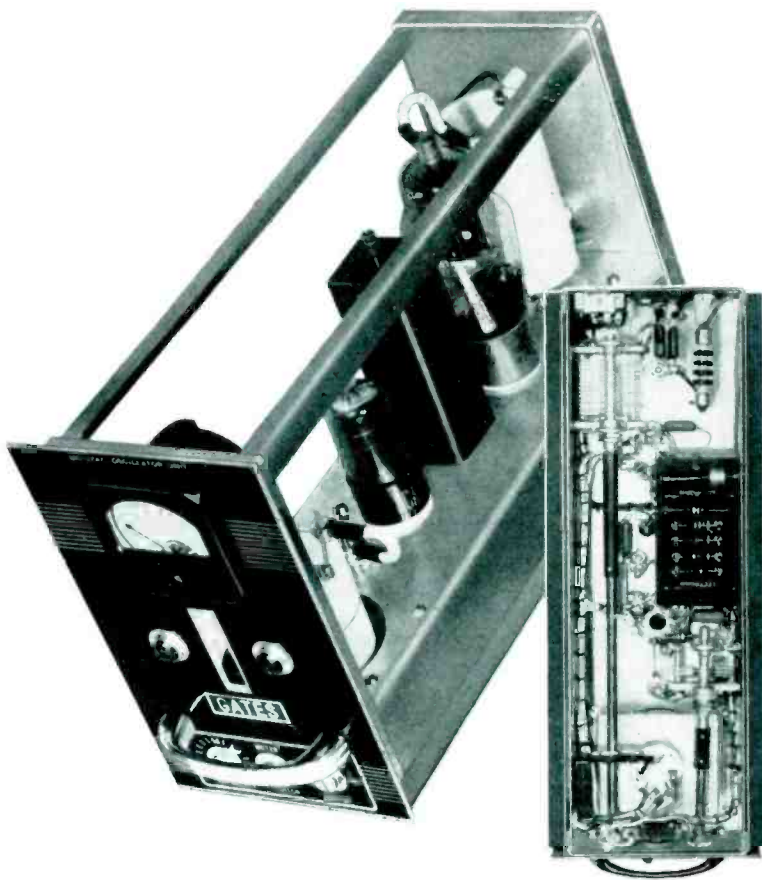

These top and bottom views of the frequency control unit show the excellent construction throughout the assembly.

GATES RADIO COMPANY
 MANUFACTURERS, ENGINEERS, SINCE 1922
 QUINCY, ILLINOIS, U.S.A.

GATES

TRANSMITTING EQUIPMENT

Below is shown that portion of the BC-250D which is seen at the top when the rear door is open. Power tubes may be withdrawn thru the rectangular opening. On the right side is the output loading coil and motor assembly and at the bottom is the inductor tuned grid circuit for the 813 driver stage.

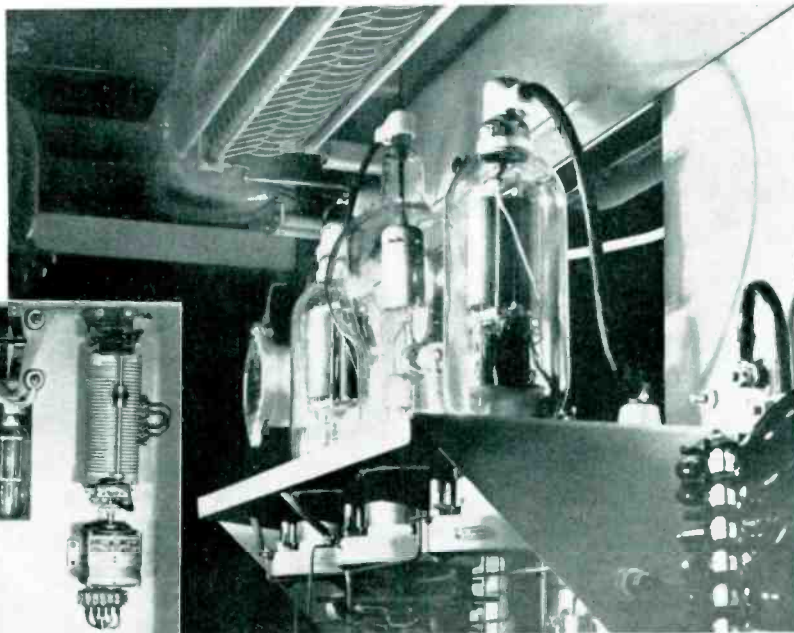
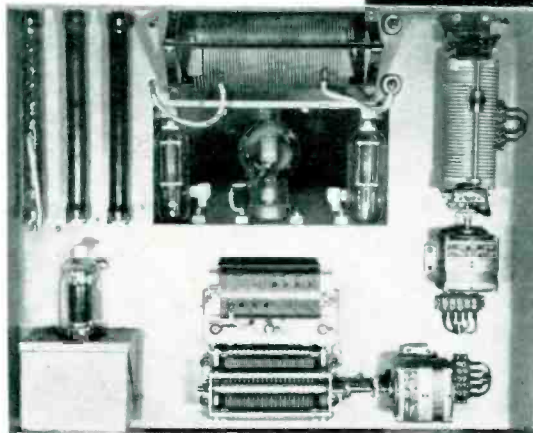

The final amplifier and modulators are shown in the illustration above. A single type 806 or 250TH may be used for the final amplifier without making any mechanical or electrical changes. The modulators are 810 tubes.

THE ANTENNA LOADING CIRCUIT.... is an L network. Either 73 or 250 ohm lines may be matched or facilities for direct coupling can be incorporated. The rotating type of coil eliminates variable air condensers in this important circuit and minimizes chances of arc overs because of over modulation or static discharges. Line meter and diode type remote reading antenna meters are standard equipment.

THE METER COMPLEMENT.... includes large 4 inch meters for antenna current, line current, plate voltage, power

amplifier current, modulator current, final grid current and 813 plate current. Separate smaller meters are employed for oscillator current (one each oscillator-buffer deck) and 813 grid current. The 807 intermediate amplifier current is indicated on the oscillator current meter by means of switching.

POWER SUPPLIES....

there are three, a pair of 8008 tubes in the full wave high voltage supply, a pair of 866 /866A tubes in the intermediate supply and a selenium bias supply all with complete fusing and relay protection.

GATES RADIO COMPANY
 MANUFACTURERS, ENGINEERS, SINCE 1922
 QUINCY, ILLINOIS, U.S.A.

GATES
TRANSMITTING EQUIPMENT
 ALL OVER THE WORLD

9

60 ~~560,000~~
 540

20 13

112 / 1500
 112
 388

112
 560
 3
 6

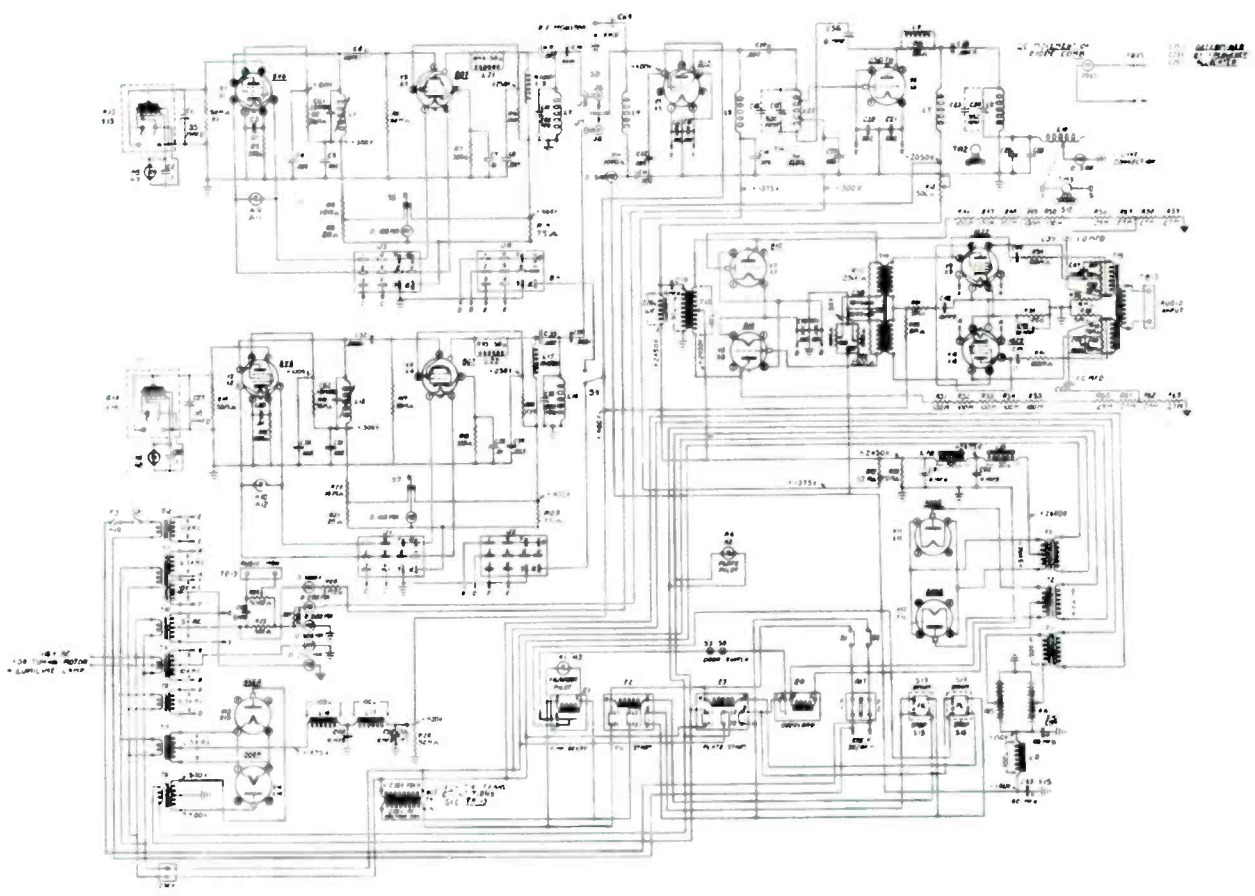

Schematic diagram of the BC-250D.

Note the "L" loading network composed of C25 and L10, overall feedback in the audio system and dual frequency control system.

GATES RADIO COMPANY
 MANUFACTURERS, ENGINEERS, SINCE 1922
 QUINCY, ILLINOIS, U.S.A.



TRANSMITTING EQUIPMENT

SPECIFICATIONS

- CARRIER POWER—250 watts.
- FREQUENCY RANGE—Any frequency from 530 to 1600 KC. (Selection to be made by customer.)
- POWER SOURCE—Normally 230 volts single phase, 60 cycles AC. Other voltages and frequencies available on special order.
- POWER CONSUMPTION—Approximately 1.7 KW.
- FREQUENCY STABILITY—+ or — 10 cycles.
- R. F. HARMONICS—Below .05%.
- AUDIO INPUT—Approximately +15 VU for 100% modulation, +10 VU for average program modulation. (Zero VU equals .001 watts across 600 ohms).
- AUDIO FREQUENCY RESPONSE—+ or — 1½ decibels, 30 to 10,000 cycles.
- AUDIO DISTORTION—100-4000 CPS, approximately 1.5% or less 50-100 and 4000,10,000, approximately 3%.
- NOISE LEVEL—Better than 60 Db. below 100% modulation unweighted.
- TUBE COMPLEMENT—Two 6V6 Oscillators } In frequency
Two 807 First Buffers } control units.
One 813 Driver.
One 806 (or 250th) Power Amplifier.
Two 1622 First Audio.
Two 810 Modulators.
Two 8008 Main Rectifier.
Two 866A Intermediate Rectifier.
- DIMENSIONS—78 inches high, 36 inches wide, 26 inches deep; constant voltage transformer 31 inches long, 9½ inches wide, 8 inches high. Packed for export approximately 87 cu. ft.
- WEIGHT—1100 lbs. net, 1500 lbs. gross, packed for domestic shipment. 2250 lbs. packed for export.

BC-250D Transmitter—Complete with two sets of tubes and two crystals and ovens. Code ZAGAR.

SALES OFFICES

123 Hampshire St.
Quincy, Illinois

1350 North Highland Ave.
Hollywood 28, California

40 Exchange Place
New York 5, N. Y.

Distributors are conveniently located
in other sections of the United States.



GATES RADIO COMPANY

MANUFACTURERS, ENGINEERS, SINCE 1922
QUINCY, ILLINOIS, U.S.A.

MODEL 250C-1 BROADCAST TRANSMITTER

This transmitter has proved itself during the past few critical years by its dependable performance; important because replacement parts were not readily available. We are proud to continue to offer the 250C-1 transmitter, improved where possible by the use of new materials, a slightly modified circuit and the application of new engineering technique.

RADIO FREQUENCY CIRCUIT

This consists of the final RF amplifier and driver stages in the main transmitter cabinet externally excited by the 25-A Frequency Control Unit. The final RF stage is a push-pull Class "C" high level modulated amplifier incorporating all the well known advantages of simple adjustment, economical operation and low maintenance common to this type of amplifier. The most outstanding advantage, and a superior advancement in the design of 250 watt transmitters, is the introduction of MOTOR TUNING in the condenser adjustments of the final stage and loading to the antenna. MOTOR TUNING has never been incorporated in the design of a 250 watt transmitter before. The simplicity of tuning on routine adjustments is evidenced by the fact that only one control is actually used in the tuning procedure and that is the reversing switch used to operate the tuning motors. The motor to be used in the adjustment is quickly selected by another switch adjacent to the tuning switch on the front panel and all operations are clearly designated above each one.

The tubes used in the final amplifier are the well known type 810. The driver stage uses one type 813. Link coupling is used to couple the output of the 25-A Frequency Control Unit to the input of the 813 driver stage.

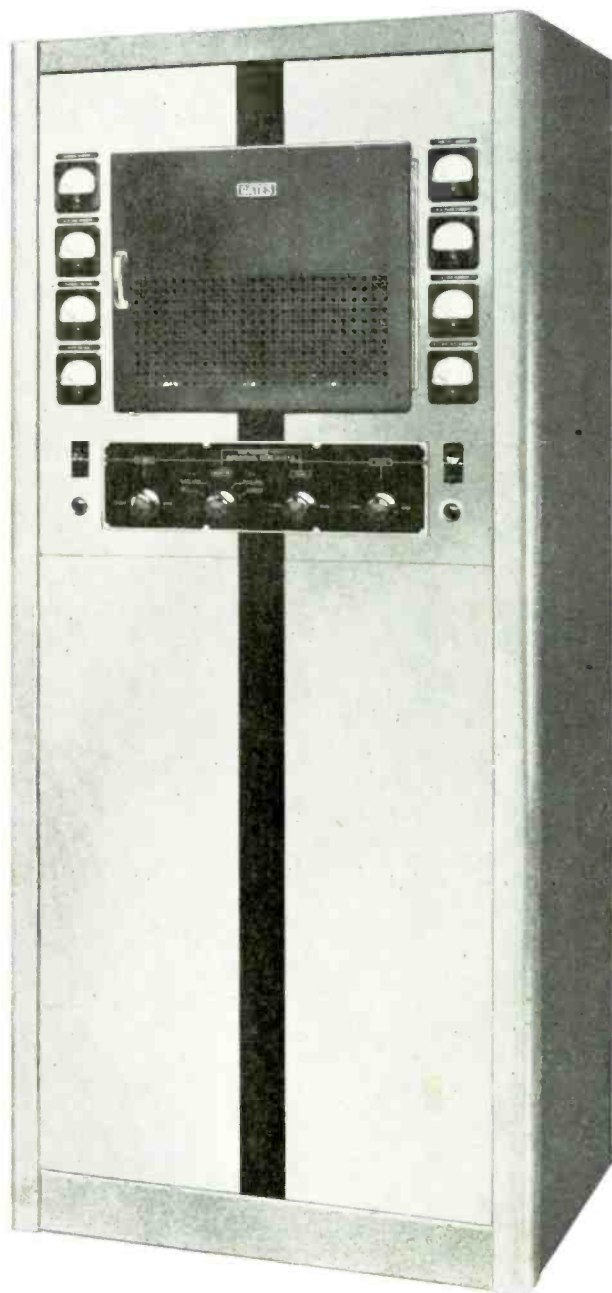

GATES

TRANSMITTING EQUIPMENT

ings at any time. The complete meter complement is as follows:

- R.F. Line Current
- Filament Voltage
- Plate Voltage
- Modulator Plate Current
- Power Amplifier Plate Current
- Power Amplifier Grid Current
- R.F. Driver Plate Current
- R.F. Driver Grid Current

The other meters associated with the transmitter are in the 25-A Frequency Control Unit and consist of the oscillator plate current meter and one each plate current meters for first and second buffers.

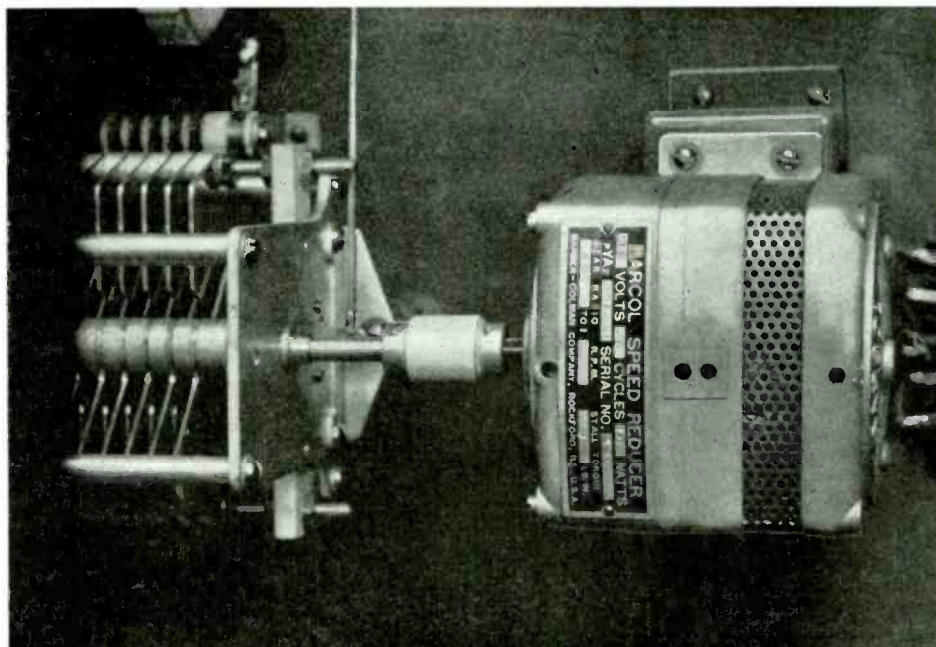

A slow speed motor accomplishes tuning adjustments easily and quickly on the 250C-1 transmitter. Its operation is controlled from the front panel.

TECHNICAL DETAIL

- CARRIER POWER:** 250 watts.
 - FREQUENCY RANGE:** 530 to 1600 KC.
 - POWER SUPPLY:** Normally supplied for 230/115 volts, 60 cycles, single phase. 115 volts single phase operation available on special order.
 - POWER CONSUMPTION:** Approximately 1.7 KW.
 - FREQUENCY STABILITY:** + or - 10 cycles.
 - RADIO FREQUENCY HARMONICS:** Below .05%.
 - AUDIO INPUT:** Zero VU for 100% modulation. -5 for average program modulation. (Zero level equals .001 watts across 600 ohms.)
 - AUDIO FREQUENCY RESPONSE:** + or - 1½ decibels, 30 to 10,000 cycles.
 - AUDIO DISTORTION:** Approximately 3% for 50 to 7,500 cycles, 0-90% modulation.
 - NOISE LEVEL:** Better than 60 db. below 100% modulation unweighted.
 - TUBE COMPLEMENT:** One 802 Oscillator, one 45 Intermediate Power Amplifier, one 802 Intermediate Power Amplifier, one 813 Intermediate Power Amplifier, two 810 Final Power Amplifier, two 1622 First Audio Amplifier, two 810 Modulator, two 872 A Rectifier, one 5Z3 Rectifier.
 - DIMENSIONS:** 76 inches high, 32 inches wide, 24 inches deep.
 - WEIGHT:** 900 lbs. net.
- 250C-1 Transmitter in gray cabinet with black front and decorative trim. Code YUTAG.

GATES RADIO COMPANY
 MANUFACTURERS, ENGINEERS, SINCE 1922
 QUINCY, ILLINOIS, U.S.A.

GATES
TRANSMITTING EQUIPMENT
ALL OVER THE WORLD

MODEL BC-1E BROADCAST TRANSMITTER

1000 WATTS

HIGH LEVEL MODULATION



Here is a 1000 watt transmitter that is better than has heretofore been offered. Outstanding among its many features are style, accessibility, good workmanship, the very best components, economical operation and a pressure type cabinet.

GATES RADIO COMPANY
MANUFACTURERS, ENGINEERS, SINCE 1922
QUINCY, ILLINOIS, U.S.A.

GATES TRANSMITTING EQUIPMENT ALL OVER THE WORLD

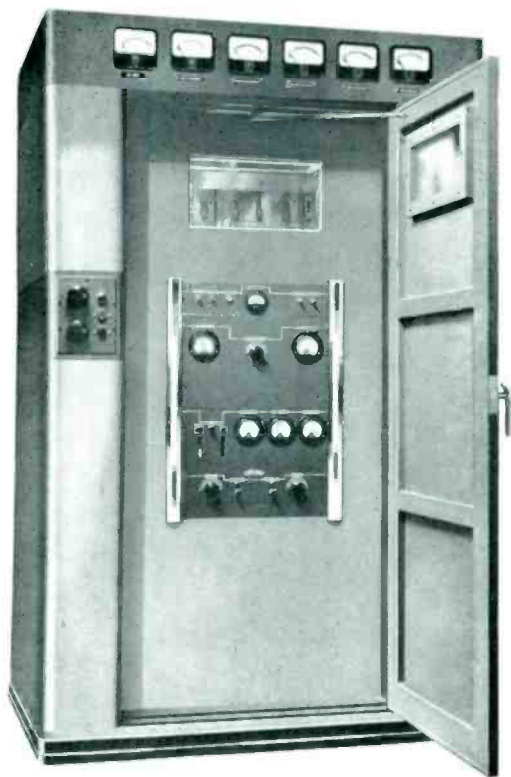

When the front door is open all low power radio frequency tuning adjustments and metering are available. No interlocks are required on the front door as the inside panel is of dead front construction. Final and modulator tubes are easily viewed thru the glass in the front panel and the door even if the door is closed.

GENERAL CONSTRUCTION

Both appearance and reliability are stressed in the design of the BC-1E transmitter. Modern lines are evident in the cabinet construction and the arrangement of the manual controls and meters is such that they are most convenient for the operator and pleasing to the eye. The cabinet is enhanced by using a multi-coat synthetic enamel, baked and hand rubbed to produce a smooth, lustrous finish. It is exceptionally easy to clean and will retain its original sheen for many years.

Internal framework chassis and panels are

copper plated and masked in appropriate places from the enamel finish to secure a good electrical bond throughout the transmitter. Welded joints throughout the angular framework assure maximum strength.

Considerable advantage in making tuning adjustments is obtained because the panel behind the front door is electrically dead and consequently the front door does not require interlocks. The back doors are, of course, interlocked to prevent access to harmful voltages when they are open.

Another major advantage is the pressure type cabinet. Dirt and dust are kept out of the equipment by building up a slight air pressure inside. This is accomplished by drawing air into the cabinet by a fan mounted inside the left back door and exhausting it thru the filtered opening in the top. The inlet is also filtered to prevent the entrance of dirt and foreign matter. These filters are easily cleaned and can be used indefinitely.

Tube life of the 833-A tube is lengthened for over normal expectancy by the small blowers located beneath them.

MAINTENANCE ACCESSIBILITY

All of the normal functions of maintenance may be accomplished thru the back doors of the BC-1E as the major circuits and components are easily reached from the back. The frequency control unit is easily removed by slipping off the style strips, taking out the few screws that hold it to the panel and sliding it out on its runners. The components on either side of the transmitter are exposed by taking off the panels on either side. Inspection is required in these sections very infrequently.

FREQUENCY CONTROL UNIT

The radio frequency signal in the BC-1E is started in the frequency control unit, separately designated as the Model 25-A. It contains the oscillator circuit, using a type 802 tube,

GATES RADIO COMPANY
MANUFACTURERS, ENGINEERS, SINCE 1922
QUINCY, ILLINOIS, U.S.A.

GATES TRANSMITTING EQUIPMENT ALL OVER THE WORLD

and two buffer stages which use a type 45 tube and a type 802 tube in that sequence. A carefully selected crystal is used to secure accurate control of the oscillator frequency. The two lightly loaded buffer stages effectively isolate the oscillator from the power amplifiers. The crystals used in the 25-A have exceptionally low drift and are mounted in Bliley BC46T temperature controlled ovens. Two may be installed and a switch is provided so that instant change may be made from one to the other.

The 802 oscillator is of the untuned plate type, very stable in operation. Average deviation over long periods of time in the field shows experience of only a few cycles variation. The first buffer, a type 45, is also untuned and lightly coupled to obtain utmost stability. The third stage, an 802 is terminated in a high impedance circuit from which the output is fed directly to the grid of the radio frequency driver stage. Power for all tube elements is obtained from a self-contained power supply on the 25-A chassis. A separate AC power line to the 25-A is terminated at the back of the transmitter and is left connected to the source at all times to permit the crystal ovens to heat at all times.

In addition to front panel switching of crystals controls are provided for making minor frequency adjustments on the oscillator and tuning the second buffer plate circuit, individual switches for application of plate power to the oscillator and buffer stages and pilot lights to show heating cycles of the crystals and power application. Three inch meters indicate oscillator plate current, second buffer grid current and second

buffer plate current. The temperature of the crystals can be easily read on the thermometers viewed through apertures on the front panel.

Particular attention has been given to maintenance of the 25-A. All terminations, including "take off" for a frequency monitor are on terminals in the rear and may be easily reached from the back of the transmitter. To make removal of the entire 25-A easy the chassis is mounted on slides and is held firmly in place by four screws in the front panel.

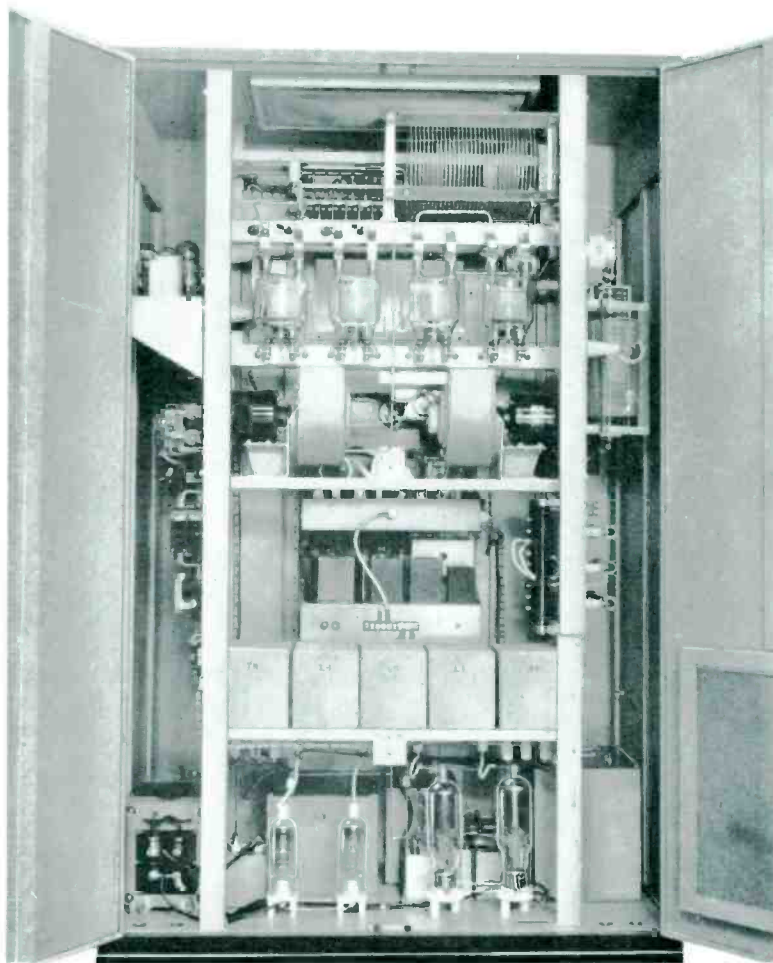

The entire rear of the transmitter opens up so that maintenance and inspection is easy.

GATES RADIO COMPANY
MANUFACTURERS, ENGINEERS, SINCE 1922
QUINCY, ILLINOIS, U.S.A.

GATES TRANSMITTING EQUIPMENT ALL OVER THE WORLD

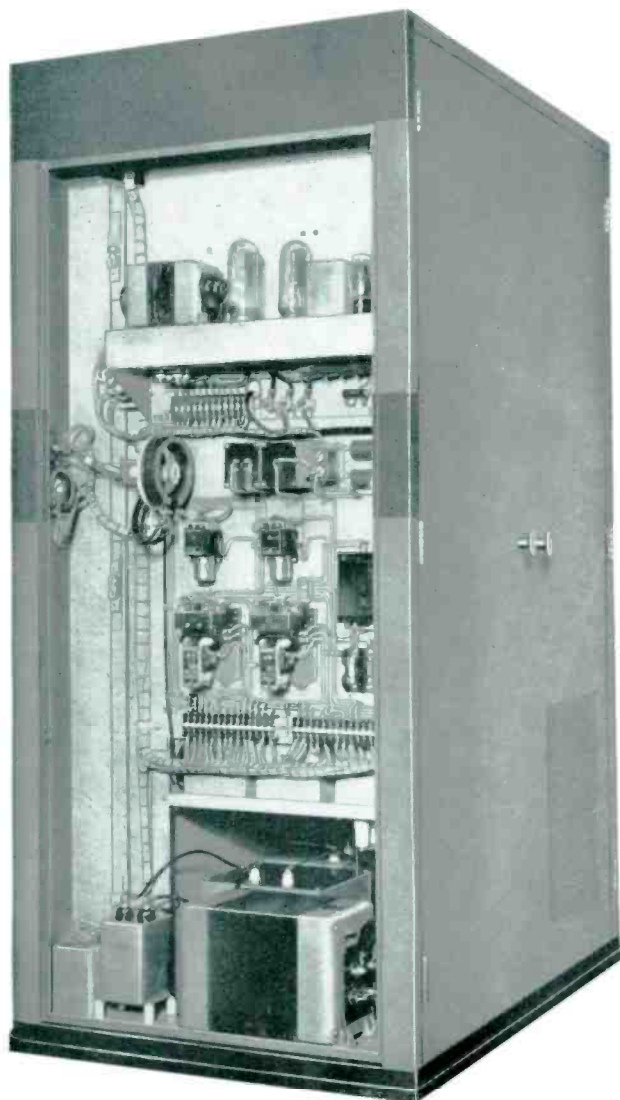

The audio amplifier deck at the top, control panel below and modulation transformer and reactor on the bottom are shown here. Notice the neat arrangement of the components and wiring — no crowded, easy to find your way around. Each electrical part here as well as in other sections of the transmitter is coded to correspond with symbols on the schematic diagram and parts lists in the instruction book.

THE R.F. DRIVER STAGE

Just above the 25-A frequency control unit is the driver chassis which contains one 813 tube and the grid and plate components necessary for its proper functioning. The R.F. from the 25-A is fed to the grid circuit of the driver thru a low capacity flexible shielded cable. Power for the tube elements is brought in on the rear of the chassis. Two meters for indicating grid and plate current in this stage are located on the front panel.

THE FINAL R.F. AMPLIFIER

The upper portion of the cabinet contains the final radio frequency amplifier. Shunt feed is used to supply the two parallel connected type 833-A tubes in this stage. Particular attention has been given to the mechanical design to obtain sturdiness and enhance the electrical characteristics. Every component operates substantially under its rating. Supporting members are made of copper plated steel angle or heavy gauge sheet accurately formed. The final plate inductor is made of edgewise wound silver plated copper ribbon mounted on mycalex spacer bars. Final tuning is accomplished by an oversize capacitor having cast aluminum plates with a rounded polished bead on all edges to reduce corona discharge. Overmodulation tests show that it is virtually impossible to induce breakdown or component heating even though applied over long periods of time.

POWER SECTION

The bottom portion of the transmitter contains the power supply components, the modulation transformer and reactor and associated parts. Type 575-A tubes are used to provide high voltage to the R.F. final amplifier and modulator. Medium voltages are supplied to all other stages except the frequency control unit by a pair of 8008 tubes.

GATES RADIO COMPANY
MANUFACTURERS, ENGINEERS, SINCE 1922
QUINCY, ILLINOIS, U.S.A.

GATES
TRANSMITTING EQUIPMENT
ALL OVER THE WORLD

CONTROL SECTION

This portion of the circuit is incorporated on a single panel on the right side of the transmitter. The control circuits consist of the power application relays for high voltage and filament voltage and overload and timing relays. The incoming AC power line fuses and main power switch of the thermal overload type are also located on this panel. Manual control of the plate voltage and filament voltage for the final R.F. amplifier is accomplished by two rheostats which are operated by knobs on the left side on the front of the BC-1E transmitter. Push button stations on the right side operate the filament start relay which also applies bias voltages. Push button stations on the left side on the front of the cabinet operate the high voltage relay. Directly adjacent are controls for tuning the final amplifier.

At the top of the control section is the bias supply which provides a fixed negative voltage for the modulator grids. This consists of a power transformer, dual selenium rectifiers and filter. The use of selenium rectifiers assures an efficient and well regulated bias supply with the inherent long life obtainable from selenium units. Balancing the bias voltages is easily done by means of two potentiometers located just inside the front door. Bias may be adjusted while full power is applied.

AUDIO SECTION

Directly above the control section is a chassis containing the first audio amplifier and the driver stages. Two type 6B4G tubes are used in the first stage and two 845's in the driver. All low voltage terminations are brought out on a sturdy barrier type phenolic terminal strip. Three ceramic insulated posts accommodate the high voltage connections.

The 833A modulator tubes are near the top of the transmitter in line with the R.F. power amplifier tubes. Associated components are located on the bottom of the cabinet.

R.F. OUTPUT COUPLING

The R.F. power amplifier of the BC-1E radio transmitter is connected single ended and couples to the transmission line or antenna through a combination harmonic filter and im-

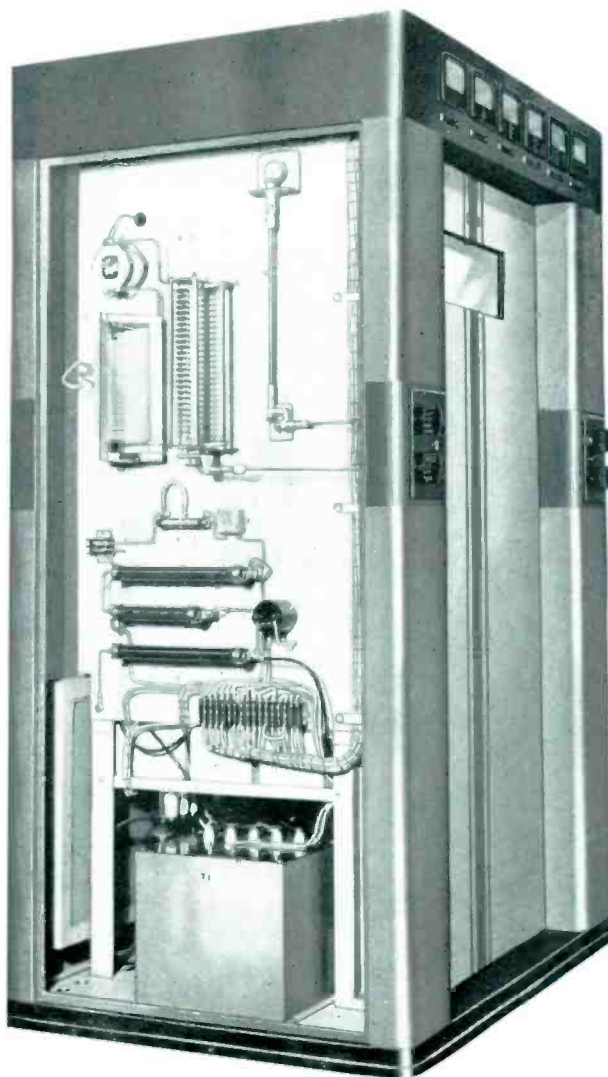

This view shows the output coupling section, large resistors and main power transformer. Notice the intake air filters at the lower left. If desired coaxial line may be brought up thru the bottom of the cabinet for convenient termination to the R. F. output.

GATES RADIO COMPANY
MANUFACTURERS, ENGINEERS, SINCE 1922
QUINCY, ILLINOIS, U.S.A.

GATES TRANSMITTING EQUIPMENT ALL OVER THE WORLD

pedance matching section. The capacity tuning in the power amplifier forms a radio frequency potentiometer, thereby adjusting by selection of components the impedance match between the modulated plate circuit and the load. The coupling adjustment consists of an L section circuit of parallel capacitance and series inductance. The loading inductance may be tapped at any point along its length and in conjunction with adjustments of the variable capacitor may be arranged to match a wide range of line impedances. The variable loading capacity is

adjusted by a knob on the left side of the front of the cabinet. Directly above is the final plate tuning knob. Positive action gear reduction and shaft assemblies assure quick easy adjustments in both the final plate tuning and loading operations.

Below the loading components are found the high voltage bleeder and bias resistors, meter multiplier and audio monitoring circuits. This latter circuit is a capacitor resistor arrangement connected to give true monitoring of carrier output.

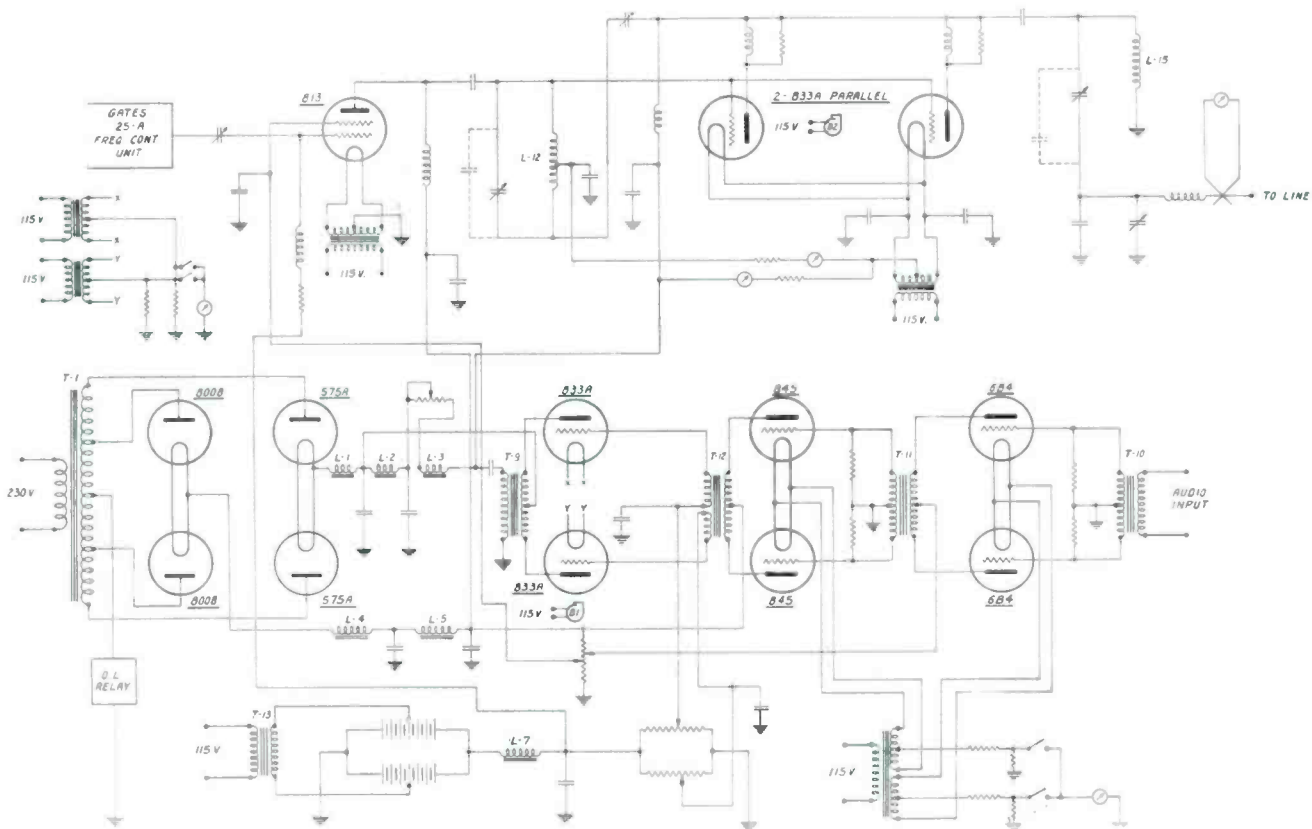

This simplified schematic of the RC-1E transmitter shows the fundamental electrical arrangement.

GATES RADIO COMPANY
MANUFACTURERS, ENGINEERS, SINCE 1922
QUINCY, ILLINOIS, U.S.A.

GATES TRANSMITTING EQUIPMENT ALL OVER THE WORLD

METERING

The meter complement for the BC-1E transmitter is complete in every way. Along the top of the cabinet are located large four inch meters for indicating R.F. line current, power amplifier grid current, power amplifier plate current, modulator plate current, power amplifier plate voltage and filament voltage for the modulator and power amplifier filaments.

Just inside the front door is found a panel containing a single meter and four switches. Two of these switches are used to connect the modulator plate current meter so that it will indicate the plate current of either or both modulator tubes. The other two connect the small meter on this panel to indicate plate current in either the first audio or driver stages. The functions of the meters found on the radio frequency driver and frequency control panels are described in the sections concerning these panels.

Metering is available for indicating plate current in every stage and grid current for the radio frequency driver and final stages.

NEUTRALIZING

The final R.F. amplifier is the only stage requiring neutralization. This adjustment is made by a screwdriver slot adjustment located next to the meter used for indicating plate current in the audio stages.

POWER CHANGING

Provision may be made for operating the BC-1E transmitter at 500 or 250 watts output by means of a series of voltage dropping resistors for the final R.F. amplifier plate voltage and an attenuator circuit to reduce the audio input to the proper level. A switch located on the front panel inside the door actuates a relay that makes the proper connections.

ACCESSORY EQUIPMENT

The normal meter complement includes an RF line current meter on the left end of the row of large meters at the top. This meter is of the external thermocouple type. If desirable a remote reading antenna current meter may be installed in place of the line current meter. It may be of the external thermocouple type or the remote diode rectifier type. The MO-2765-A diode rectifier remote antenna current meter consists of a meter having a one milliamperere movement with a scale calibrated in R.F. amperes and a small unit containing a current transformer and rectifier. The rectifier and current transformer unit are generally located inside the antenna tuning unit at the antenna. Negligible power is required by the current transformer to operate this device.

A complete line of antenna tuning units are available for use with the BC-1E transmitters. Detailed information on them will be found in catalog sheets devoted to the subject. The MO-2786-A series of antenna tuning units incorporate the MO-2765-A diode type remote antenna current meter and also two or three coil lighting chokes.

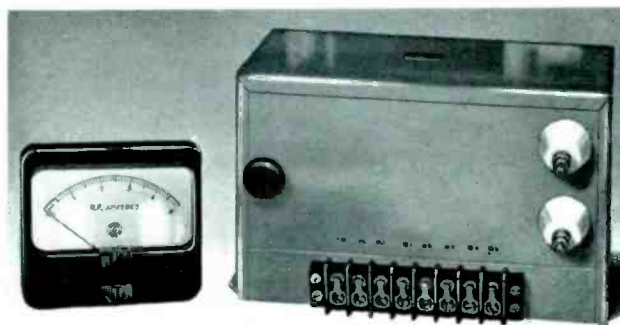

Remote antenna current diode unit, MO-2765-A. The meter provided matches those along the top of the BC-1E transmitter.

GATES RADIO COMPANY
MANUFACTURERS, ENGINEERS, SINCE 1922
QUINCY, ILLINOIS, U.S.A.



TRANSMITTING EQUIPMENT

SPECIFICATIONS

POWER OUTPUT—1000 watts. May be operated as 1000/500 watt, 1000/250 watt, 500/250 watt, or as a 500 watt transmitter. Power reduction may be incorporated to suit requirements.

FREQUENCY RANGE—Any frequency from 530 to 1600 KC. (To be specified by customer.)

FREQUENCY STABILITY—Plus or minus 10 cycles maximum.

POWER INPUT—Average program modulation, 1000 watts output, approximately 5.6 KW; 500 watts output, approximately 4.0 KW.

POWER SUPPLY—230 volts, 50/60 cycles, single phase. Variation not to exceed plus or minus 10%.

TYPE OF MODULATION—High level Class "B".

A.F. INPUT LEVEL—For 100% modulation, plus 6 vu.; at average program level plus 3 vu.

FREQUENCY RESPONSE—Within 1½ db. from 30 to 10,000 cycles.

DISTORTION—Approximately 3% from 50 to 7500 cycles. 0-95% mod.

NOISE LEVEL—60 db. below 100% modulation unweighted.

R.F. HARMONICS—Less than .03%.

TUBE COMPLEMENT—

1—802 Oscillator	} In 25-A Frequency Control Unit
1—45 Buffer	
1—802 I.P.A.	
1—813 I.P.A.	
2—833-A Power Amplifiers	
2—6B4-G Speech Amplifiers	
2—845 Audio Drivers	
2—833-A Modulators	
2—575-A Rectifiers	
2—8008 Rectifiers	
1—5Z3 Rectifier	

SALES OFFICES

123 Hampshire	40 Exchange Place
Quincy, Illinois	New York 5, N. Y.

Distributors are conveniently located
in other sections of the United States



GATES RADIO COMPANY

MANUFACTURERS, ENGINEERS, SINCE 1922
QUINCY, ILLINOIS, U.S.A.

GATES
TRANSMITTING EQUIPMENT
ALL OVER THE WORLD

BC-5A and BC-10A BROADCAST TRANSMITTERS

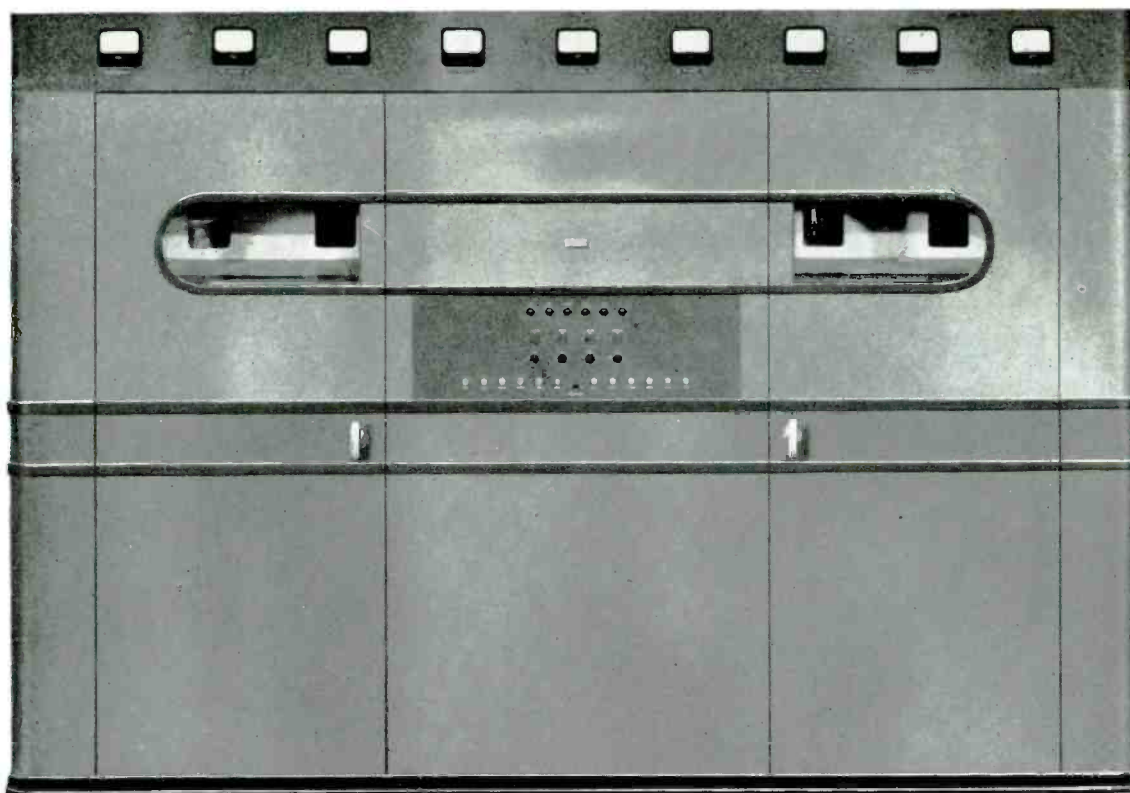

BC-5A — 5000 WATTS

BC-10A — 10,000 WATTS

GATES RADIO COMPANY
MANUFACTURERS, ENGINEERS, SINCE 1922
QUINCY, ILLINOIS, U.S.A.

GATES
TRANSMITTING EQUIPMENT
ALL OVER THE WORLD

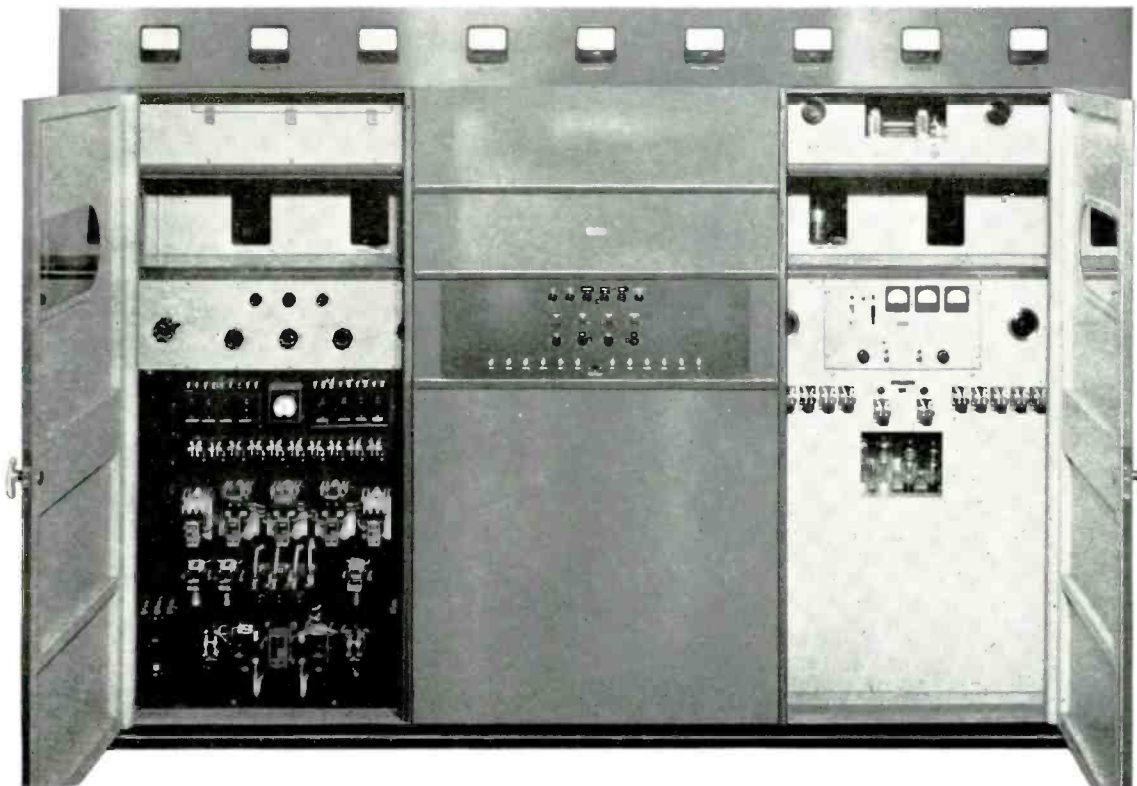

With the front doors open every control facility is within easy reach.

MAJOR consideration has been given in the design of the BC-5-10A transmitters to the heavy duty service imposed upon broadcast equipment, the need for complete continuous checks of all operating functions, and the requirement for ease of service. They have been developed along practical machinery lines with modern styling added to provide the pleasing appearance needed for showmanship in the modern broadcast installation. Accessibility is stressed. Virtually any individual component may be reached for examination or replacement without removing any other item other than the mounting hardware. The operating personnel may walk into the transmitter en-

closure and directly reach all sections of the unit without removing secondary barriers or other obstructions. All principal tubes may be viewed while the transmitter is in operation. All controls may be reached from dead front panels. The entire Power Distribution Panel may be reached while the transmitter is operating.

In every respect the BC-5-10A radio transmitters have been built along lines giving maximum interruption free service, with the belief that the practical operating engineer and station manager will find in them more desirable features than any other similar equipment.

GATES RADIO COMPANY
MANUFACTURERS, ENGINEERS, SINCE 1922
QUINCY, ILLINOIS, U.S.A.

GATES
TRANSMITTING EQUIPMENT
ALL OVER THE WORLD

OUTSTANDING FEATURES

As the result of a poll taken of station engineers from many United States and foreign broadcast stations, numerous engineering advancements desired were incorporated in the Gates BC-5-10A transmitters, a few of which are:

1 A variable gas pressure final plate circuit tuning capacitor is used. This arrangement allows continuously variable tuning without concern about moving contacts on coils, brush heating, or dust effects commonly found in air capacitors. The gas pressure in this capacitor is maintained at 150 pounds and is constantly checked by an automatic electric cutoff safety valve. Should pressure drop below the required value, the plate circuit contactor is automatically opened.

The power control system is illustrated at the right. This is a closeup of the apparatus behind the left door shown on the opposite page. Note that thermal type overload switches control the various circuit branches. The rotating controls near the top are for filament voltage adjustments and meter selection.

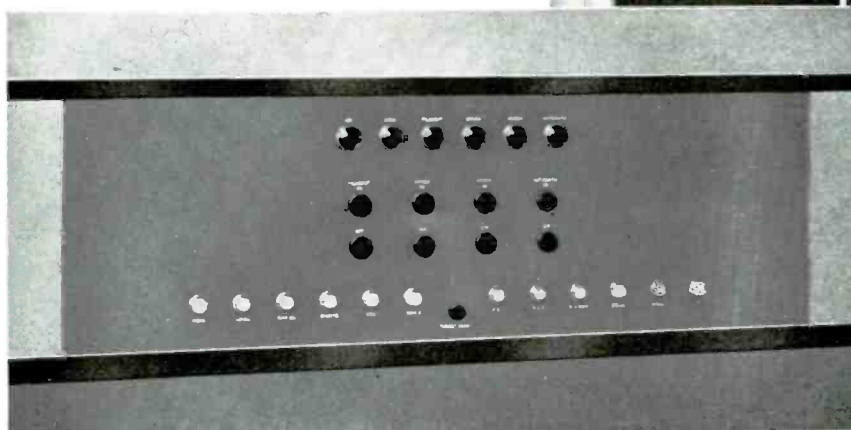
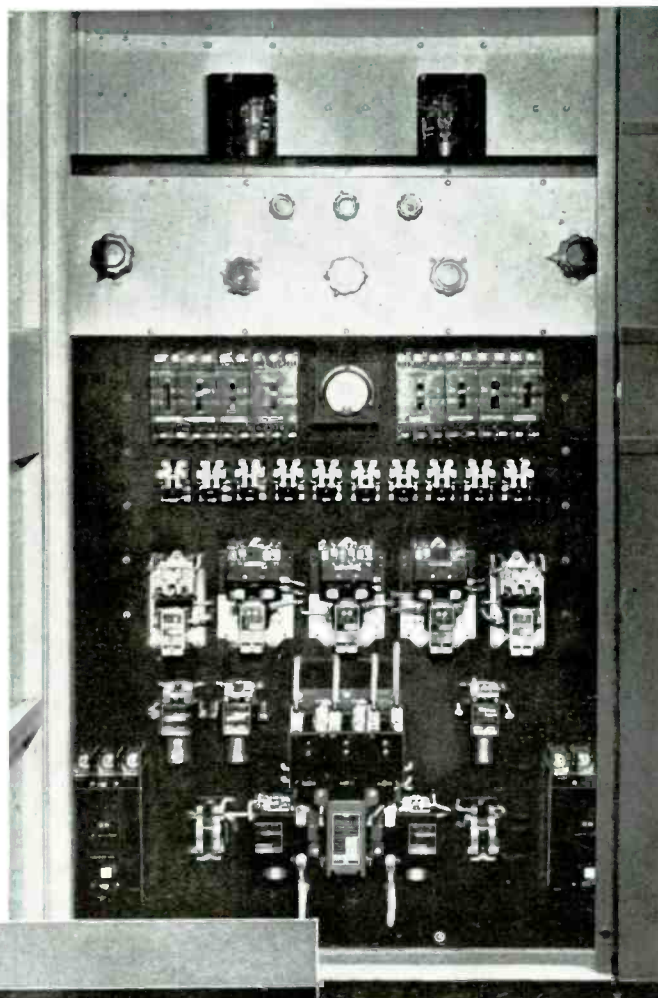

The supervisory control panel is shown on the left. Besides controlling and indicating the sequence of power application, circuit faults are quickly indicated by the small lights across the bottom of this panel.

GATES RADIO COMPANY
 MANUFACTURERS, ENGINEERS, SINCE 1922
 QUINCY, ILLINOIS, U.S.A.

GATES
TRANSMITTING EQUIPMENT
 ALL OVER THE WORLD

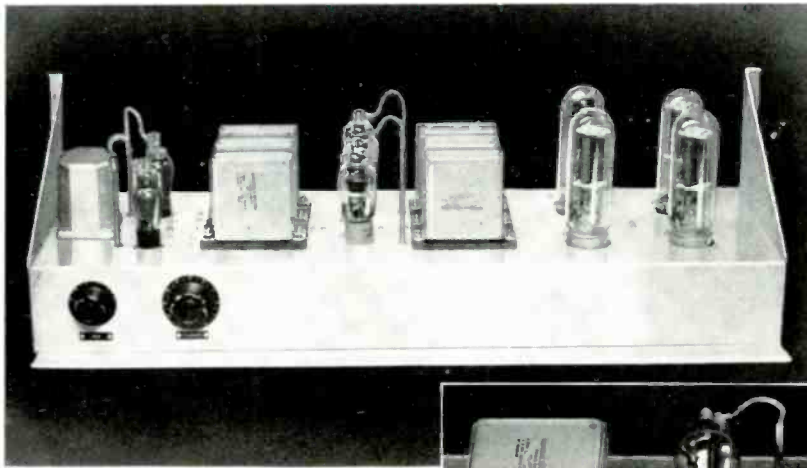

◀ Top view of the audio amplifier shelf. The controls are for gain and feedback.

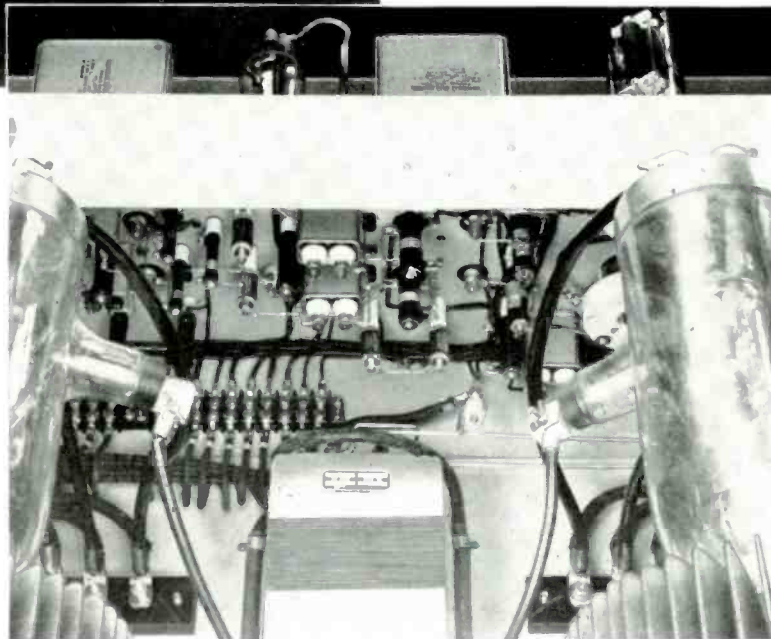

▶ This shows the bottom view of the audio shelf as it appears with the bottom shield removed.

2 A combination impedance matching network and harmonic filter is incorporated to simplify coupling to a directional antenna system and to give maximum harmonic suppression.

3 Automatic power reset after an overload is incorporated. The transmitter may be operated either with the automatic reset or

without using this feature. If the automatic reset is used a pilot light indicates that it is in "ready" position. After the first overload and automatic reset the "automatic" pilot light goes off indicating to the operator that an overload has occurred and that for further automatic resetting it is necessary to reinstate the automatic relay circuit.

GATES RADIO COMPANY
 MANUFACTURERS, ENGINEERS, SINCE 1922
 QUINCY, ILLINOIS, U.S.A.

GATES
TRANSMITTING EQUIPMENT
ALL OVER THE WORLD

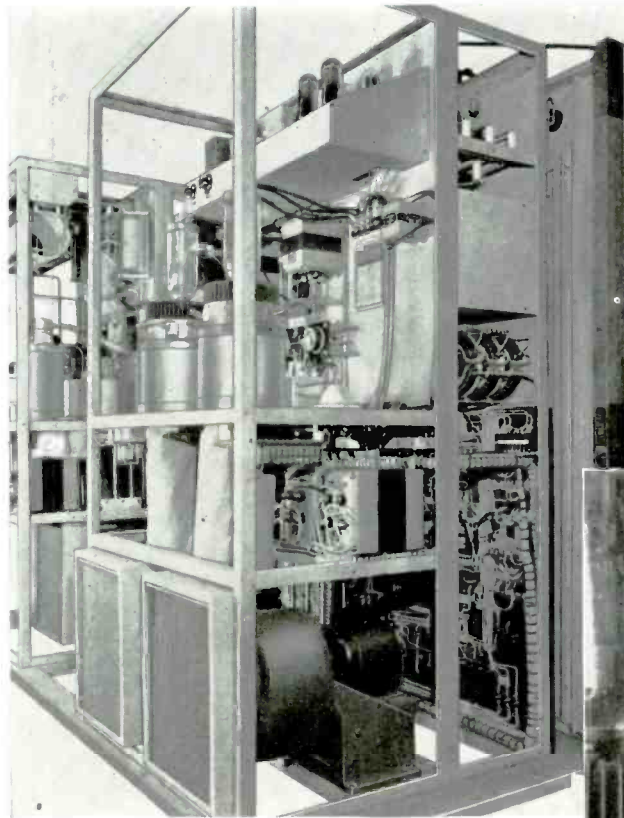

the interval of the pushing the "OFF" and pushing the "ON" push button. This change may be made instantaneously by setting the automatic restoration circuits and merely pushing the plate "OFF" push button. The automatic sequence system will then immediately cause the transmitter to operate at the different power selection. An external circuit arrangement

◀ On the left is the rear view of the modulator section of the BC-5A-10A. Each modulator tube is individually cooled by a large blower assuring longer life. Throughout this entire section every component may be easily examined.

4 Power switching is instantaneous with virtually no carrier interruption. Power switching may be made either up or down by simple push button operation. A HI-LOW power switch is mounted on the R.F. control panel directly under the 25-A Frequency Control Unit. This switch may be thrown without actually changing the transmitter output power. The position of this switch may be set for the next period of operation and the transmitter will automatically operate at the power selected (normally 5-1 or 10-5 KW) upon the next operation of the plate voltage push button station. If the plate voltage push button station is used to change power the carrier is interrupted for

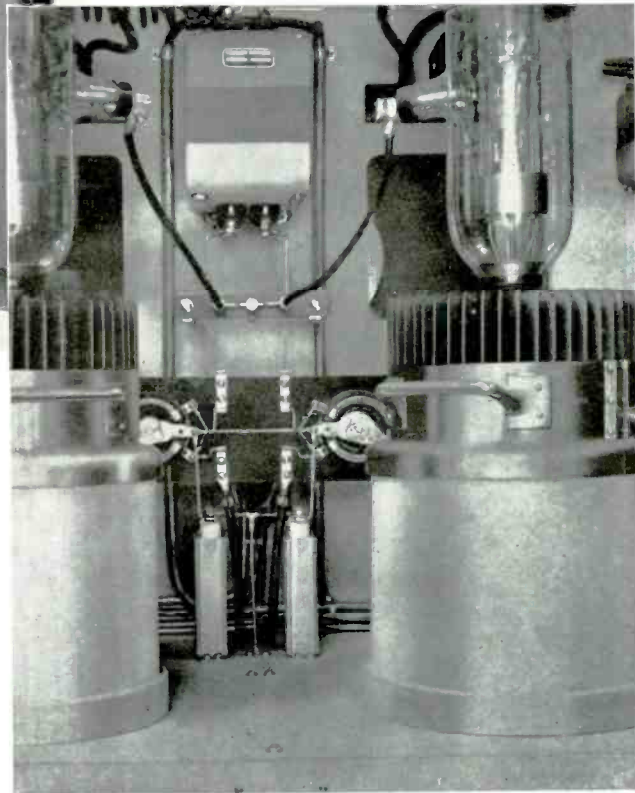

Above are the two modulator tubes with the driver transformer and related components shown between them.

GATES RADIO COMPANY
MANUFACTURERS, ENGINEERS, SINCE 1922
QUINCY, ILLINOIS, U.S.A.

GATES
TRANSMITTING EQUIPMENT
ALL OVER THE WORLD

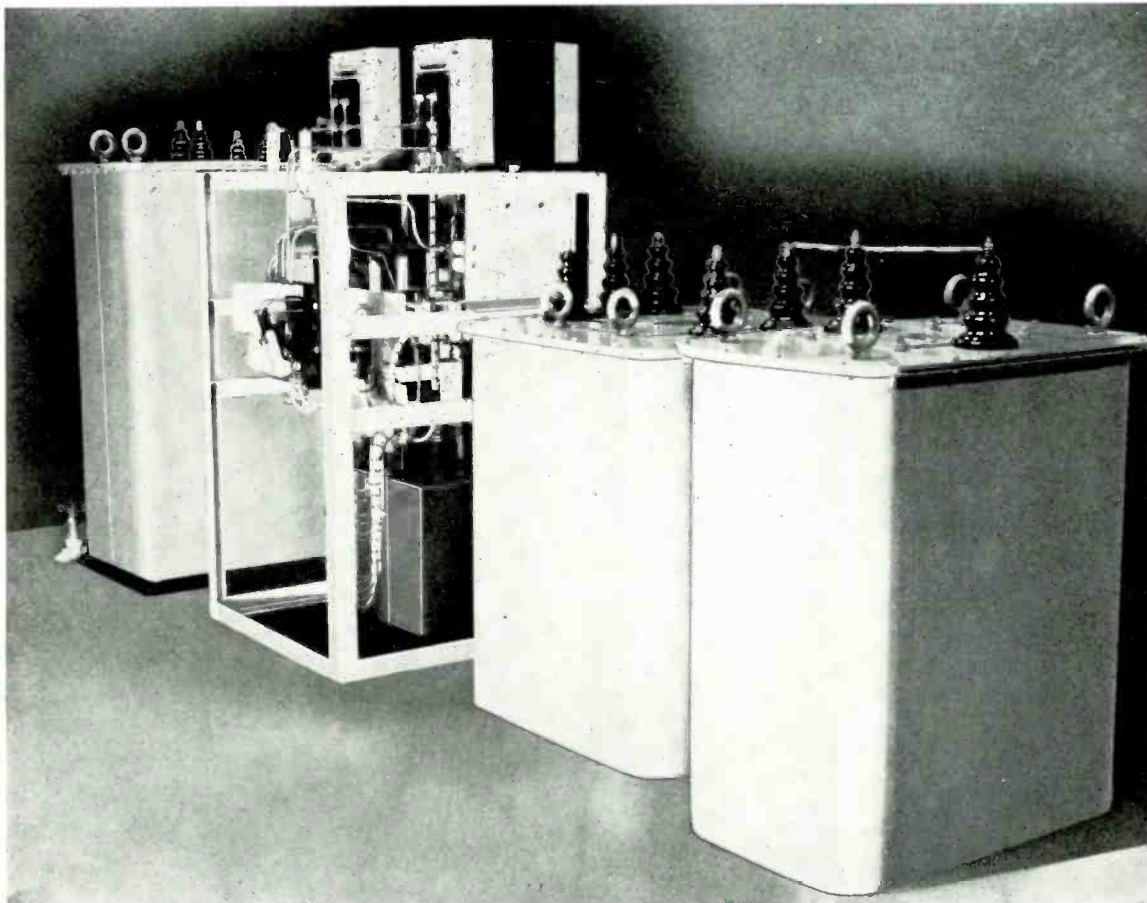

The power transformer, filter assembly, modulation transformer and reactor are shown above.

is available for operating phasing system relays and accomplishing the power change simultaneously.

- 5 Supervisory load lamps are of the neon type which will have extremely long life.
- 6 All components operate at a point far beneath their normal power handling rating.
- 7 The BC-5-10A is protected against rust and corrosion by the generous application of

heavy copper plating and numerous coats of hard industrial enamel.

CONTROL FACILITIES

The Gates BC-5-10A radio transmitters are equipped with extremely complete control circuits. The main power circuit breaker provides a complete disconnect of all voltage except the crystal heater. This main circuit breaker is both a disconnect and a thermal overload pro-

GATES RADIO COMPANY
MANUFACTURERS, ENGINEERS, SINCE 1922
QUINCY, ILLINOIS, U.S.A.

GATES

TRANSMITTING EQUIPMENT

tection. It also incorporates instantaneous magnetic overload coils and breakers for each phase of the 230 volt supply.

Following the main breaker, all principal circuit branches are protected by both sequence contactors and separate thermal circuit overload units. The sequence system incorporated in the EC-5-10A absolutely prevents any component damage through incorrect push button operation.

The timing circuits are particularly important and advanced in design. The rectifier plate voltages, both in bias and plate power supplies, are automatically withheld for a period of twenty seconds by a solenoid timing device. The filament pilot light does not light until this timing relay has performed its sequence operation.

After application of plate voltage the main filter condensers are allowed to charge gradually for a period of approximately one second before they are placed directly across the line, thus eliminating high current surges that would damage rectifier tubes and overload power supply components.

Another timing relay keeps the blower system operating for approximately one minute after final transmitter shut-down preventing damage to high-powered vacuum tubes through heat accumulation.

All principal circuits and high-powered vacuum tubes have overload indication on pilot lights

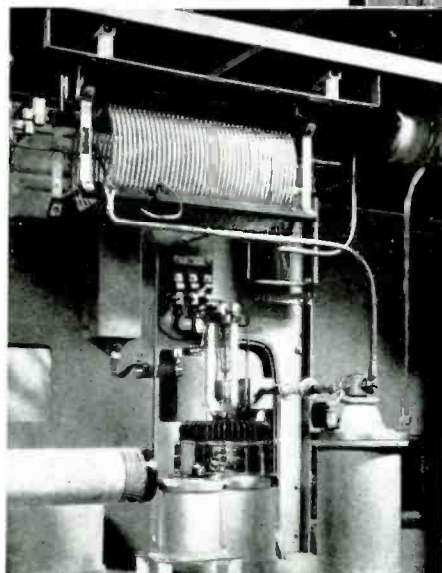
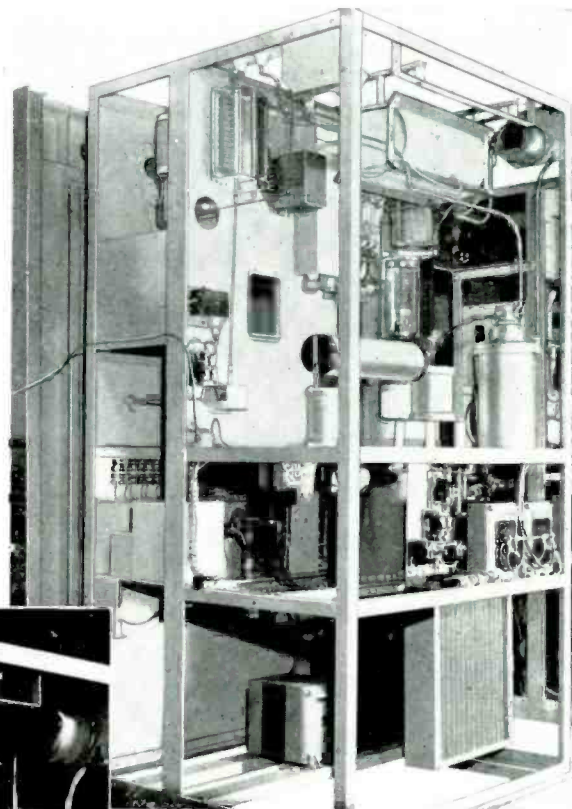

▲ The R.F. amplifier unit, above, is arranged for 5 k.w. operation as it has just a single tube in the final stage. For 10 k.w. operation another socket is installed behind the plate choke and an additional blower, filament, transformer and other minor parts are supplied. The changes are easily and quickly made in the field if necessary.

▲ On the left is shown a closeup of the R.F. final amplifier. The upright cylindrical object in the right foreground is the nitrogen filled plate tuning capacitor for the final.

which remain lighted until turned off by the lamp reset switch. If, for example, one modulator tube has a "gas ping," a supervisory relay operates and holds a signal lamp on so that the operator may make note of the circuit fault

GATES RADIO COMPANY
 MANUFACTURERS, ENGINEERS, SINCE 1922
 QUINCY, ILLINOIS, U.S.A.

TRANSMITTING EQUIPMENT

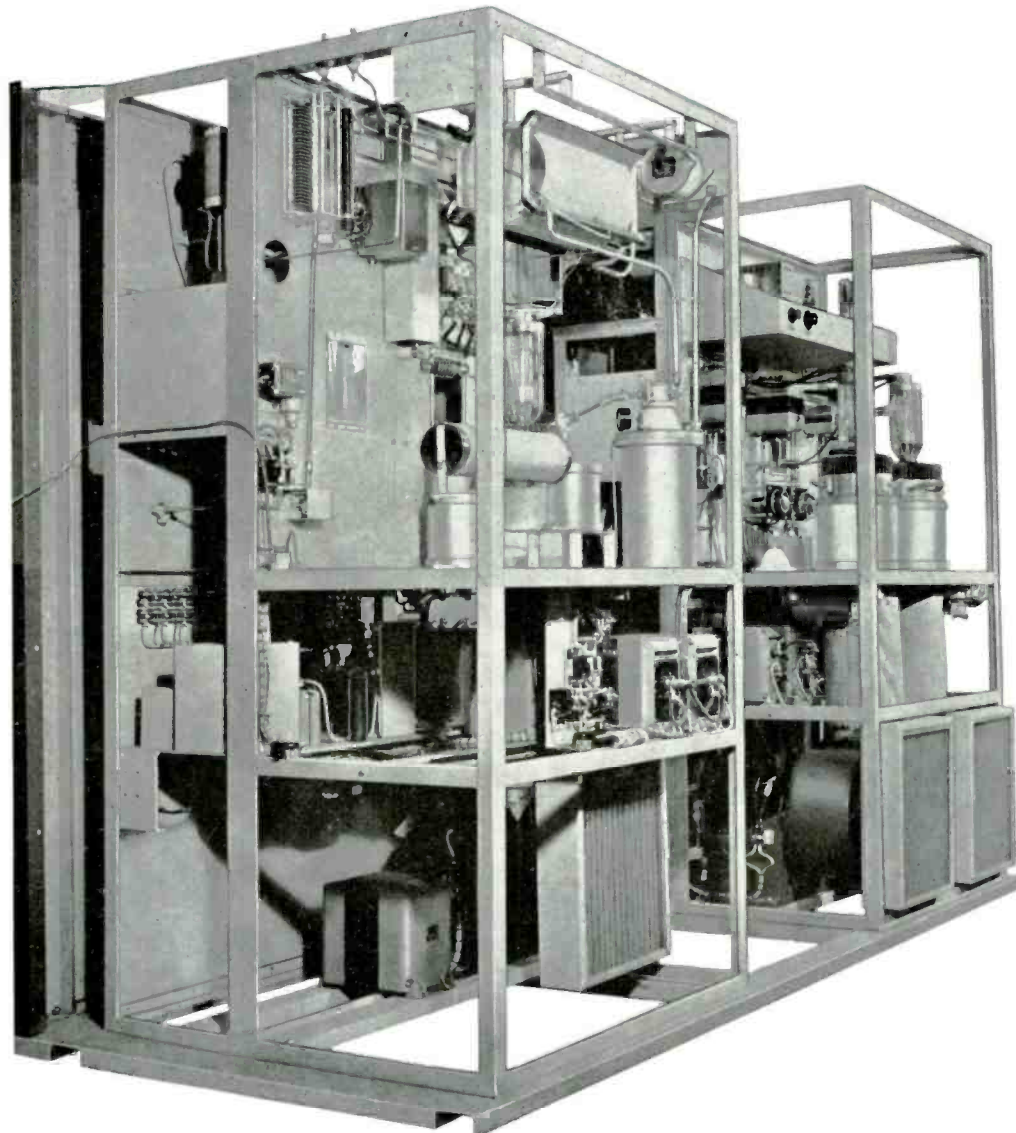

Back view of the BC-5A-10A transmitter. The R.F. Amplifier section is in the foreground, the audio section in the background.

and position Overload or under-voltage lamp
circuits indicate the following functions:

Gas pressure in condenser at safe value
Driver rectifier overload

Bias rectifier overload and under-voltage
Power tube overloads
Overloads on main rectifier and line
Power amplifier excitation
Status of automatic reset.

GATES RADIO COMPANY
 MANUFACTURERS, ENGINEERS, SINCE 1922
 QUINCY, ILLINOIS, U.S.A.

GATES

TRANSMITTING EQUIPMENT

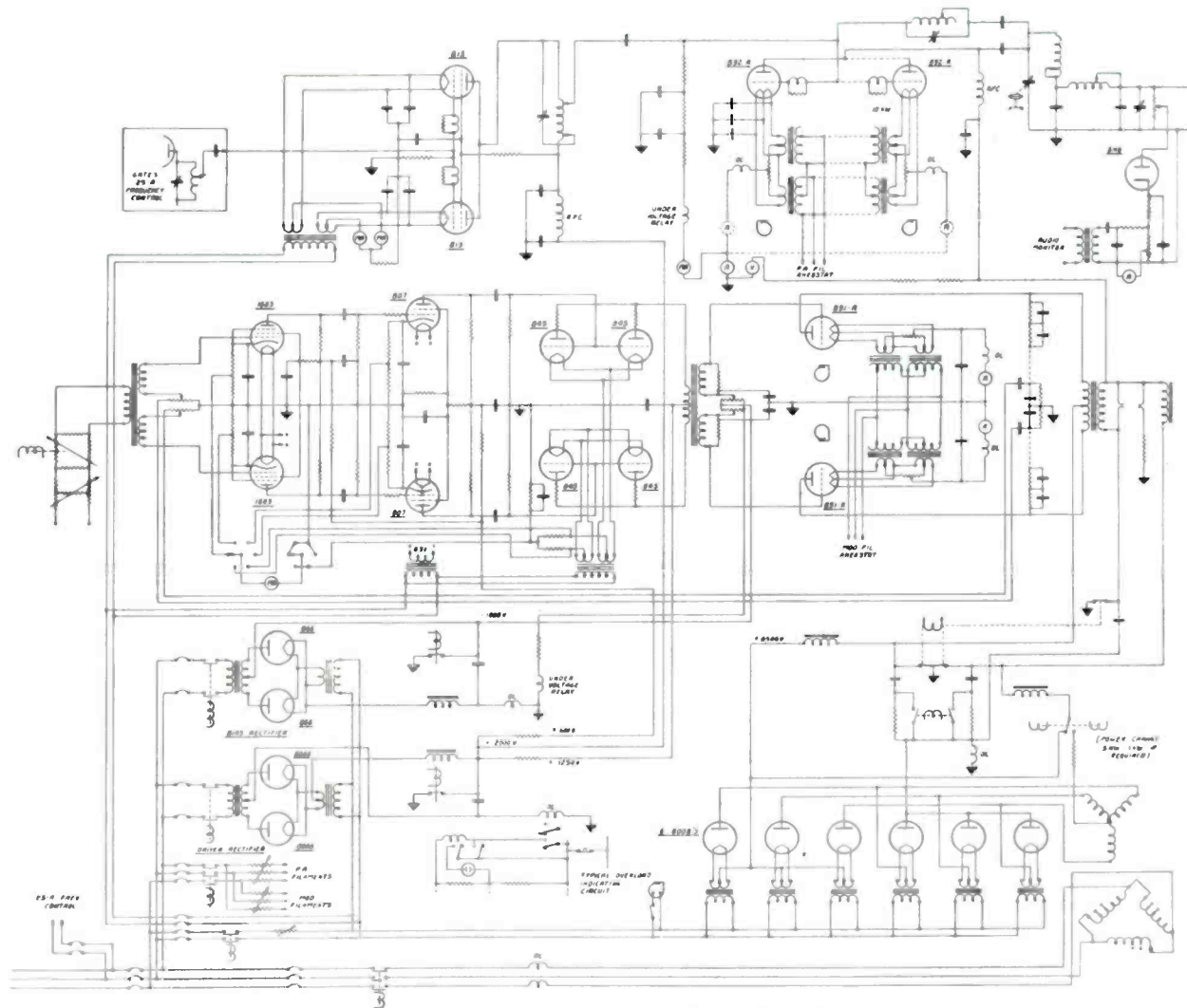

Simplified Schematic Diagram of the BC-5A Transmitter.
 Dotted lines show changes and additions for the BC-10A.

**FUNDAMENTAL CIRCUIT
 OF THE BC-5-10-A**

The fundamental circuits of the BC-5-10A consist of a straight forward radio frequency amplifier and a high level modulator. Radio frequency is generated in the Gates time

proven 25-A Frequency Control Unit. This is amplified by a driver stage of two type 813 vacuum tubes, followed by one or two 892-R air-cooled vacuum tubes used as modulated class "C" power amplifiers. All audio frequency stages are push-pull and engineered to exceed all high fidelity standards. Modulators are two type 891-R tubes in class "B" operation.

GATES RADIO COMPANY
 MANUFACTURERS, ENGINEERS, SINCE 1922
 QUINCY, ILLINOIS, U.S.A.

GATES
TRANSMITTING EQUIPMENT
ALL OVER THE WORLD



METERING

Complete metering is featured on the Gates BC-5-10A radio transmitters. Meters continuously indicate all plate currents in the radio frequency amplifier and all important grid currents. A variety of output metering arrangements is available and may consist of a common point thermocouple into a directional antenna array or may include a remote indicating rectifier meter on a single non-directional antenna. Numerous other combinations can be used as required by the individual installation.

The audio frequency low level stages are completely metered on a test meter switch arrangement. This audio frequency metering checks both sides of all push-pull stages. Individual meters are connected in both modulator plate circuits, and read continuously. Filament voltages and the three phase voltages of the input line are also indicated on selector meters.

◀ This phasing cabinet is arranged for operation as part of a two tower system: non-directional days, directional nights. Any desired arrangement can be worked out by our engineering department in conjunction with your consultant.

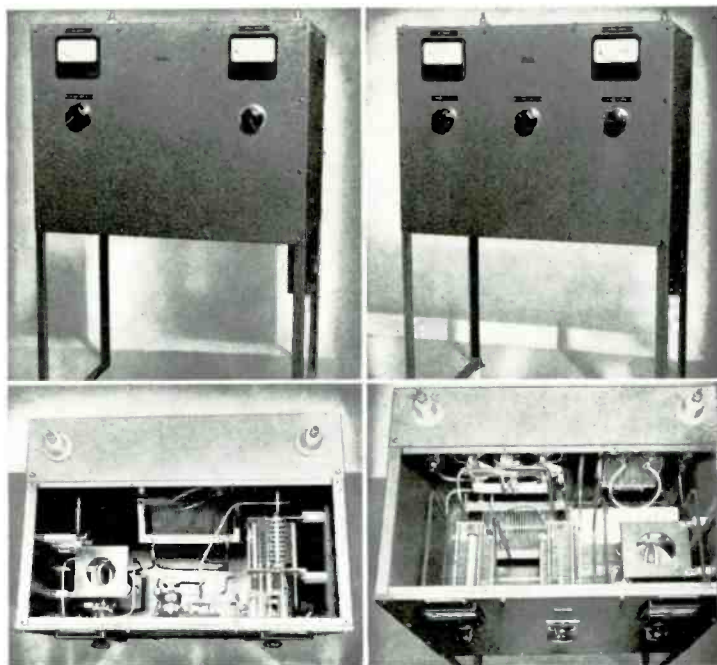

These are front and inside views of the two antenna couplers used with the phaser on the left.

GATES RADIO COMPANY
MANUFACTURERS, ENGINEERS, SINCE 1922
QUINCY, ILLINOIS, U.S.A.
www.americanradiohistory.com

GATES

TRANSMITTING EQUIPMENT

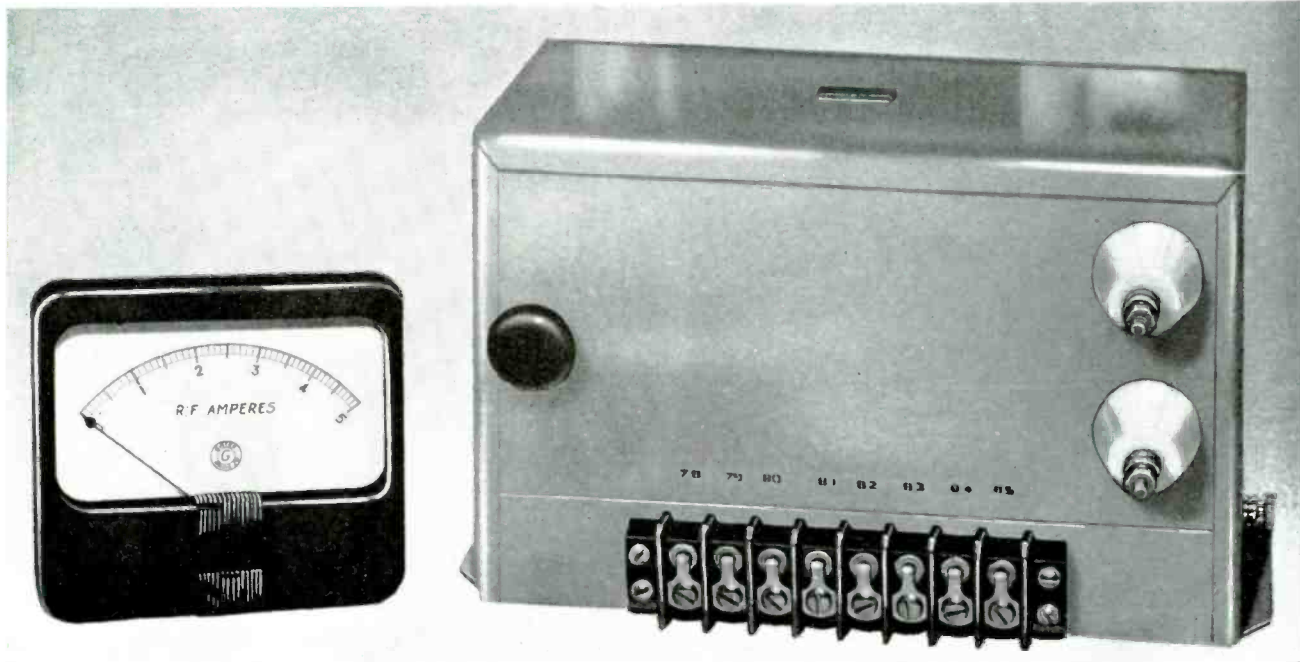

MO-2765-B diode rectifier antenna current meter may be used wherever it is desired to have indication of R.F. current from a remote point. Send for complete information on this and other special apparatus.

OPERATING SPECIFICATIONS

The Gates BC-5-10A Radio Transmitting Equipments are designed for high fidelity broadcast operation in the standard 530-1600 Kcs band. The normal characteristics of these transmitter units when properly installed and adjusted, are as follows:

- (1) Carrier power output—5000 watts (BC-5A), 10,000 watts (BC-10A), with instantaneous power reduction to 5000 or 1000 watts and/or change to directional antenna as required.
- (2) Carrier frequency range—530-1600 Kcs (to customer's selection).
- (3) Carrier frequency stability—Within 10 cycles.
- (4) Modulation capability—100%.
- (5) Audio frequency response—+ or — 1 DB 30-10,000 cycles.
- (6) Carrier and hum level—Approximately 60 DB below 100% modulation.
- (7) Total RMS distortion at 90% modulation—100-4000 cycles approximately 2% or less; 50-100 and 4000-7500 cycles approximately 3%.
- (8) Output impedance—50-300 ohms (to customer's specifications).
- (9) Audio input—0-DBM for average program modulation—600 ohms.
- (10) Power consumption—
 - BC-5A, for 5000 watt operation:
 - 23 KVA—100% tone modulation.
 - 17 KVA—unmodulated.
 - 18.2 KVA—normal program modulation.
 - BC-5A, for 1000 watt operation:
 - 15 KVA—100% tone modulation.
 - 13 KVA—unmodulated.
 - 13.4 KVA—normal program modulation.
 - BC-10A, for 10,000 watt operation:
 - 37 KVA—100% tone modulation.
 - 27 KVA—unmodulated.
 - 30 KVA—average modulation.
- (11) Power supply—220 volt, 3 phase, 50/60 cps.
- (12) Power Factor—92% approximately.
- (13) Suggested Room Ventilation—exhaust provision 3000 CFM.

GATES RADIO COMPANY
 MANUFACTURERS, ENGINEERS, SINCE 1922
 QUINCY, ILLINOIS, U.S.A.



COMPLETE CUSTOMER SERVICE

The procurement of a multiplicity of accessory items and coordination of thought and action of the group of people generally associated with a 5000 or 10,000 watt installation need not be a problem when installing a Gates transmitter. A complete engineering service is available and may be arranged to work with your Consulting Engineer, Chief Engineer, Manager, and all suppliers to obtain all accessory materials and equipment such as phasing equipment, antenna tuning units, antennae, transmission lines, phase monitors, ground wire or any other items needed to complete the system. This service will be gladly explained in detail upon request.

Phasing and tuning equipment for your installation is of particular importance and individual production and engineering talent is provided to see that complete coordination is obtained between your Consulting Engineer and our staff. Virtually a daily check is made on the progress of your transmitter and accessory equipment by engineering and sales executives to assure you of prompt liaison functions in obtaining your exact requirements.

SALES OFFICES

123 Hampshire
Quincy, Illinois

40 Exchange Place
New York 5, N. Y.

Distributors are conveniently located
in other sections of the United States

BC-5A—Transmitter for operation from 230 volts, 60 cycles, 3 phase AC source, complete with two sets of tubes and two crystals and ovens—Code word ZAASF.

BC-10A—Transmitter for operation from 230 volt, 60 cycles, 3 phase AC source, complete with two sets of tubes and two crystals and ovens—Code word ZAAWJ.



GATES RADIO COMPANY
MANUFACTURERS, ENGINEERS, SINCE 1922
QUINCY, ILLINOIS, U.S.A.

GATES
TRANSMITTING EQUIPMENT
ALL OVER THE WORLD

FREQUENCY MODULATED BROADCAST TRANSMITTER

Model BF-250A
250 Watts
Approved by the FCC



GATES RADIO COMPANY
MANUFACTURERS, ENGINEERS, SINCE 1922
QUINCY, ILLINOIS, U.S.A.

GATES
TRANSMITTING EQUIPMENT
ALL OVER THE WORLD

THIS transmitter will provide 250 watts of frequency modulated power to a properly designed antenna and transmission line system on any frequency from 88 to 108 megacycles. Characteristics obtained in any proper installation will exceed those required by the Federal Communications Commission for FM broadcast service.

Installations requiring in excess of 250 watts can use the BF-250A as the basic exciter unit for one or three kilowatt amplifiers or obtain still more power by adding still higher powered stages.

Modulator and Frequency Multiplier

Modulation is accomplished in the BF-250A by the phase shift method utilizing a GL-2H21 vacuum tube. This system makes possible direct crystal control of the carrier frequency and thereby eliminates a multiplicity of tubes and mechanical controls inherent in many systems. The small amount of audio power required for modulation is provided by a two stage amplifier which also contains the pre-emphasis circuit. The audio input level required is relatively low so that if desired a fixed attenuator may be inserted to obtain accurate matching to auxiliary audio equipment having comparatively low output level.

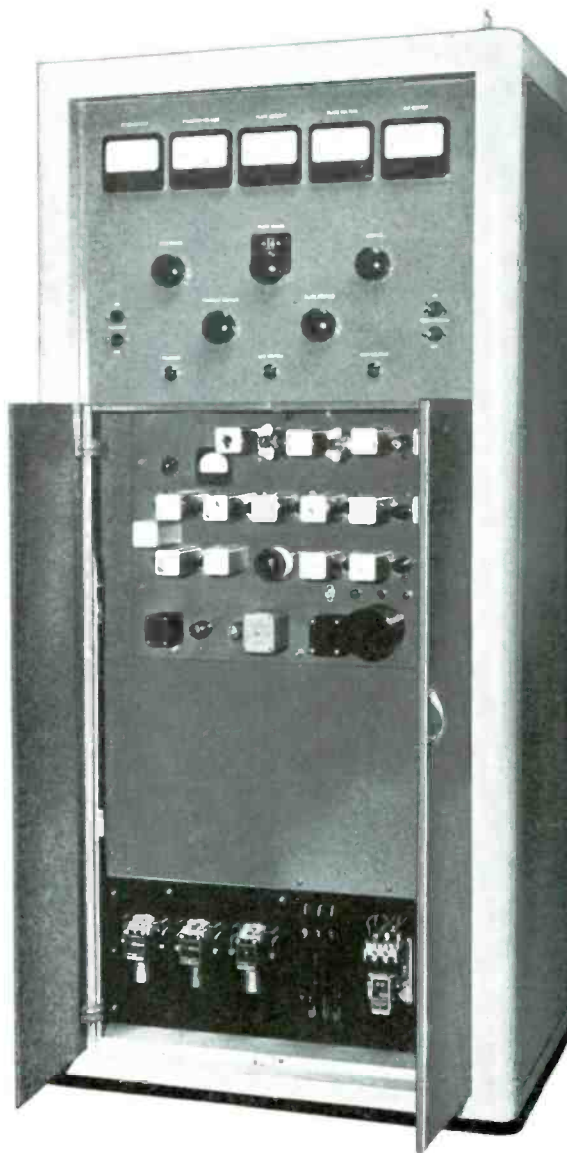

Grouping of the controls on the BF-250A is arranged so that operation is easy. Four inch meters are used to facilitate accurate adjustments. Switches and relays are along the bottom—easily reached when the front doors are opened.

GATES RADIO COMPANY
MANUFACTURERS, ENGINEERS, SINCE 1922
QUINCY, ILLINOIS, U.S.A.

GATES
TRANSMITTING EQUIPMENT
ALL OVER THE WORLD

Two temperature controlled crystals are provided, either selected by a switch, to generate and control the original frequency. This frequency is in the neighborhood of 200 kilocycles and is fed to the GL-2H21, modulated and then further increased to the carrier frequency by a series of multiplier stages. Following this

is a driver amplifier that has ample output to drive the final RF amplifier stage.

Indication of plate current in the low powered stages is available on a milliammeter which operates in conjunction with a selector switch to connect it in any desired amplifier stage.

The neat arrangement in the back of the BF-250A is evidence of the careful design work on this unit. All components are readily accessible and properly placed to best perform their appointed functions. The cover of the modulator-amplifier section (center) is quickly removable and exposes all components. Note the generously proportioned power components at the bottom.

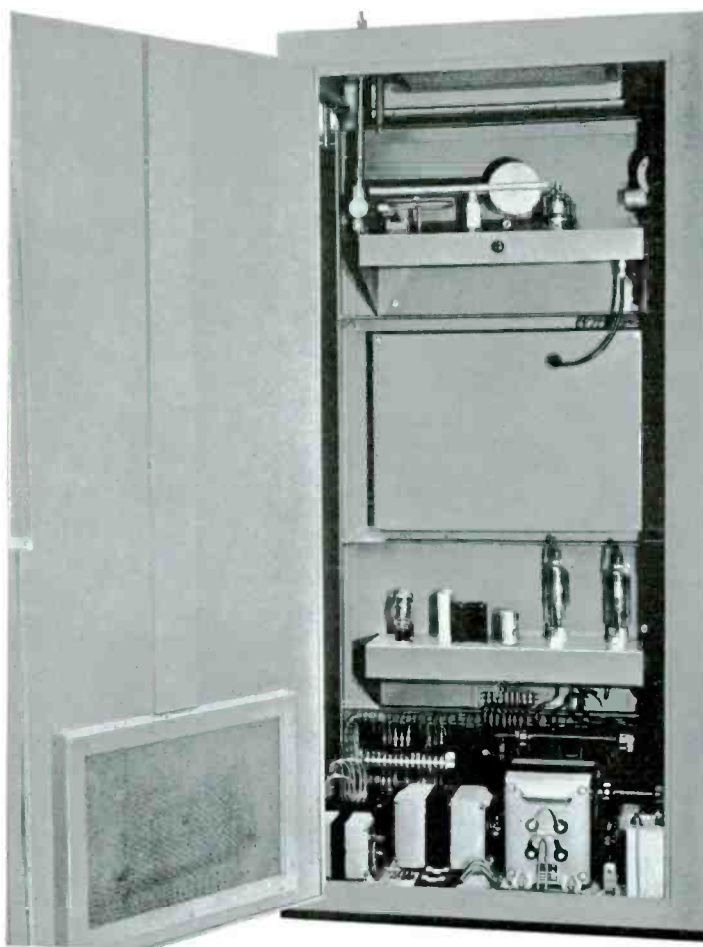

GATES RADIO COMPANY
MANUFACTURERS, ENGINEERS, SINCE 1922
QUINCY, ILLINOIS, U.S.A.

GATES
TRANSMITTING EQUIPMENT
ALL OVER THE WORLD

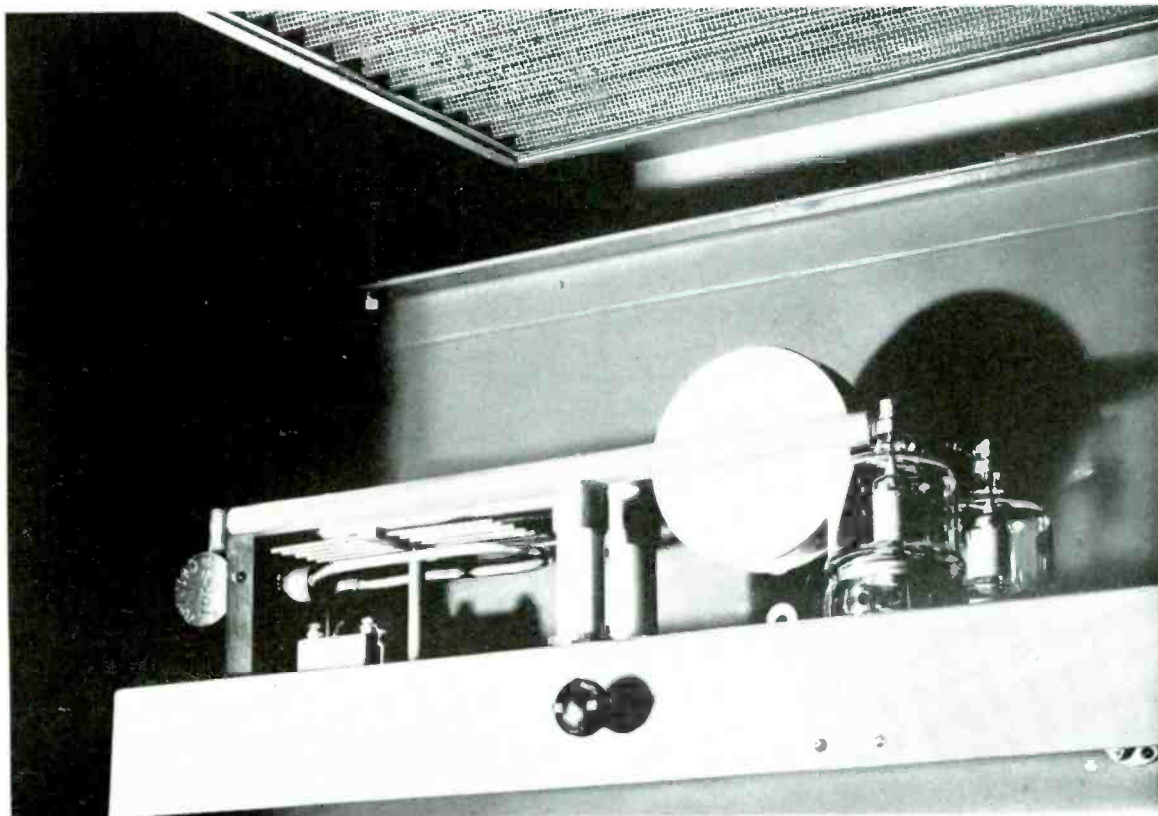

This view of the final amplifier clearly shows the tank circuit construction and placement of the type 4-125A tubes. All metallic parts that perform electrical functions are silver plated. A blower, not shown, provides a blast of air for cooling the tubes, thus materially extending their life.

Tuning of each stage is easily done by observing the indications of a vacuum tube tuning meter when plugged into jacks directly adjacent to the stage under observation. This item is supplied with each transmitter. The design of the multiplier stages allows easy adjustment to maximum performance by use of this simple transmitter accessory.

Power Amplifier

A short length of concentric transmission line is used to carry power from the driver stage to the grid circuit of the two type 4-125A power amplifier tubes. They are connected in push-pull using as a tank circuit a single turn inductance actually composed of two

GATES RADIO COMPANY
MANUFACTURERS, ENGINEERS, SINCE 1922
QUINCY, ILLINOIS, U.S.A.

GATES TRANSMITTING EQUIPMENT ALL OVER THE WORLD

metallic tubes mounted parallel to each other, one end of each being connected to the plates of the tubes and the other ends shorted together by a movable bar. The bar may be placed in a position suitable for obtaining approximate resonance of the tank circuit. Fine adjustments are secured by spacing of the round plates located near the open end of the tank inductance. One of these is positioned by a control knob on the front panel. Power is taken from the final amplifier by means of a small loop located just below the plate inductance. An electrostatic shield is placed between it and the plate inductance to balance

loading on each power amplifier tube and thereby obtain optimum efficiency. The pick-up feeds the power into a $\frac{7}{8}$ inch concentric transmission line which is brought out thru the top of the transmitter where it may be connected to the transmission line to the antenna or to a successive power amplifier.

This view shows the power components and rectifier tubes. All wiring is neatly arranged and designated for quick comparison with diagrams in the instruction book to facilitate maintenance.

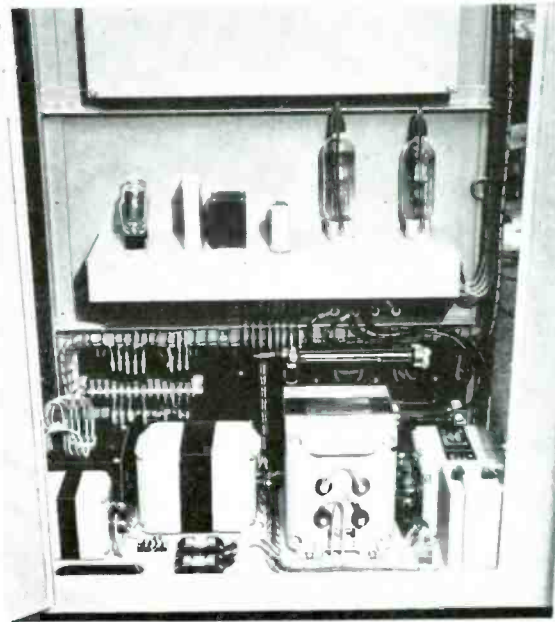

Construction

Standard practices used in the building of the BF-250A transmitter are silver plating of all inductances that carry RF power, copper plating on all chassis and frame members, using over size components in all circuit breakers

is employed to furnish protection to the equipment and interlocks on the rear door prevent operating personnel from accidental contact with dangerous voltages when the door is open.

GATES RADIO COMPANY
MANUFACTURERS, ENGINEERS, SINCE 1922
QUINCY, ILLINOIS, U.S.A.

GATES
TRANSMITTING EQUIPMENT
ALL OVER THE WORLD

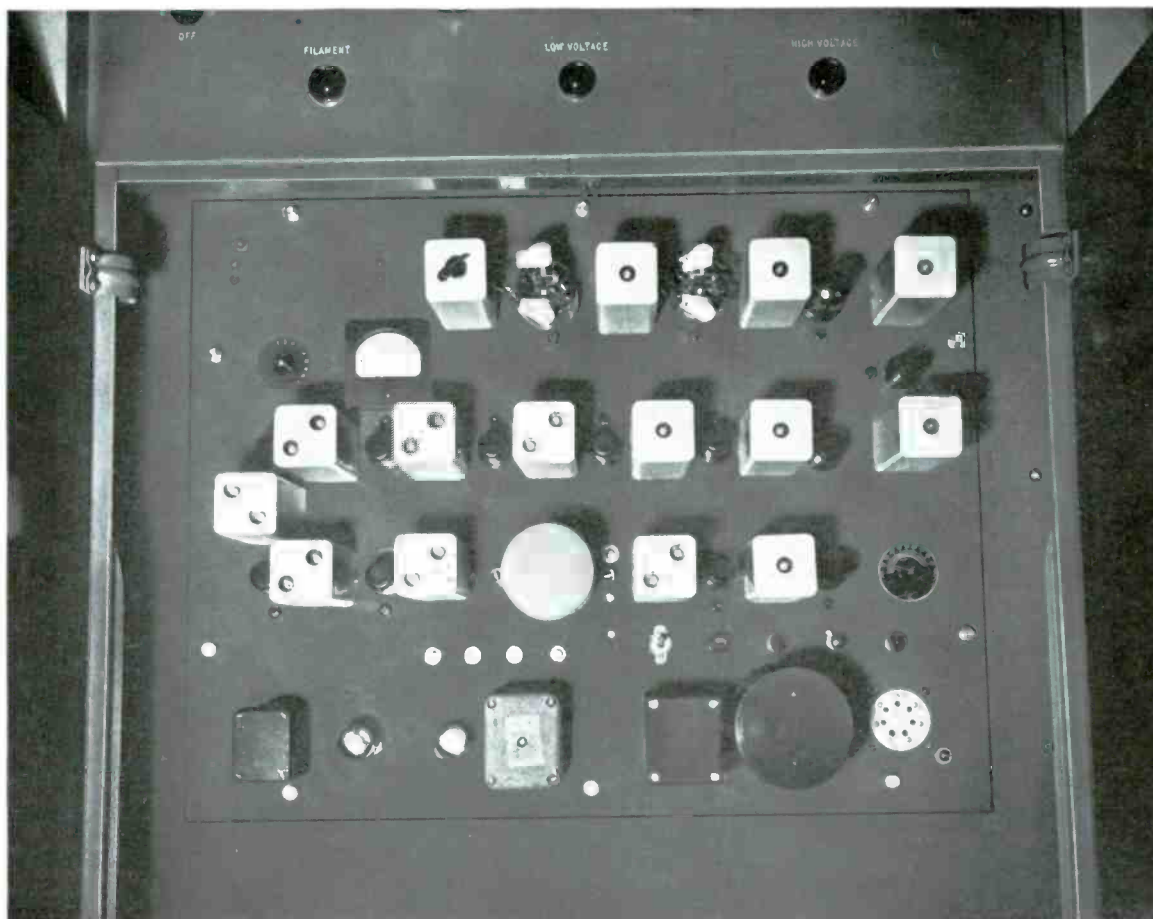

The modulator-amplifier section shown above is the heart of the BF-250A transmitter. In the second row of components inside the round shield is the GL-21121 tube which performs the modulation. The modulation inductance is built inside the shield and is easily removable for tube replacements. The blank socket in the lower right corner accommodates the second crystal and oven.

Access to all components is possible thru either the back or front doors. However, the sides of the cabinet are also removable to further assist maintenance. The cabinet is dust and insect proof but has ample ventilation thru the filters in the bottom of the rear door and

top of the cabinet. Forced air circulation is used on the power amplifier stage which increases tube life. Blower noise is inaudible a short distance from the transmitter facilitating the use of announcing provisions in the same room if desirable.

GATES RADIO COMPANY
MANUFACTURERS, ENGINEERS, SINCE 1922
QUINCY, ILLINOIS, U.S.A.



TRANSMITTING EQUIPMENT

Controls and Meters

Push button stations are located on the front panel for application of filament and plate voltages with indicators that light when the filament, low voltage and high voltage supplies are operating. Three rheostats controlled from the front panel adjust filament and plate and allow the power output to be varied from approximately 50 to 320 watts. Power am-

plifier grid and plate tuning controls are also located on the front panel. The plate tuning control is associated with a counter that shows the setting within one part in three hundred.

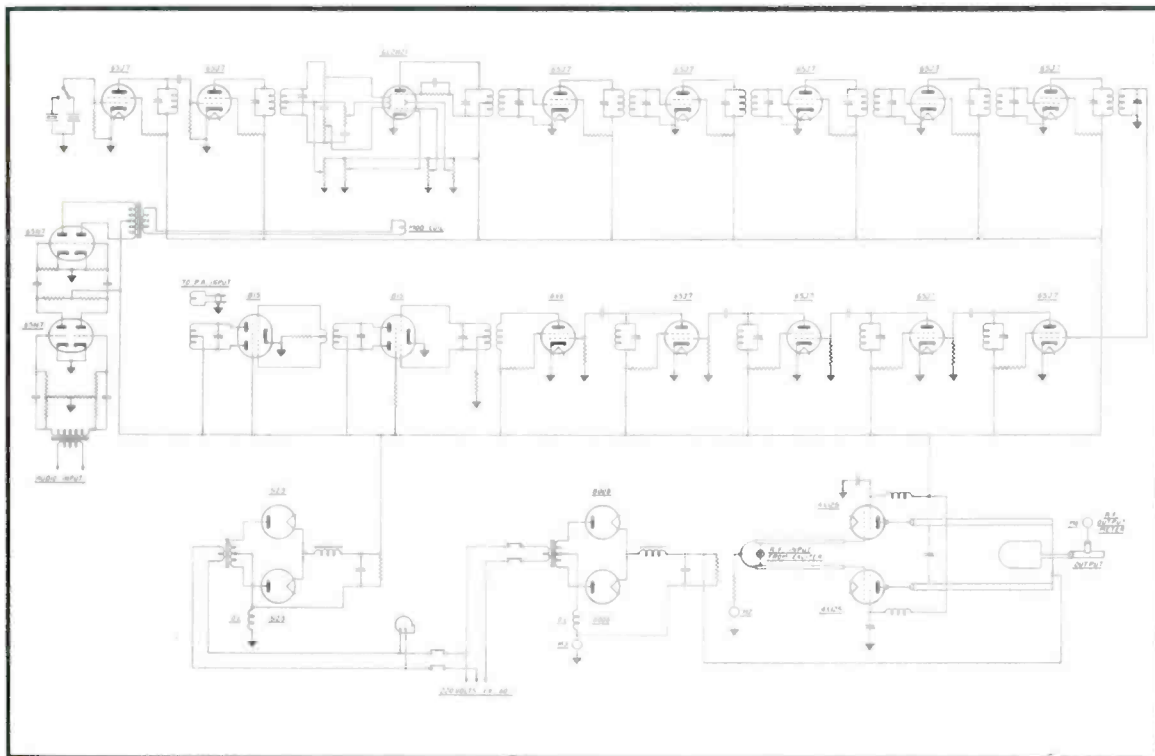
Five four-inch meters are mounted along the top of the front panel and indicate power amplifier grid current, plate current, plate voltage, filament voltage and RF output.



This schematic shows the major circuit functions of the BU-250A transmitter.

GATES RADIO COMPANY
 MANUFACTURERS, ENGINEERS, SINCE 1922
 QUINCY, ILLINOIS, U.S.A.



TRANSMITTING EQUIPMENT

SPECIFICATIONS

POWER OUTPUT—250 watts nominal rating.
FREQUENCY RANGE—88 to 108 megacycles.
RF OUTPUT IMPEDANCE—40-80 ohms.
TYPE OF OSCILLATOR—Direct crystal control.
FREQUENCY STABILITY— ± 250 cycles.
TYPE OF MODULATION—Phase shift.
MODULATION CAPABILITY—100 kilocycles.
AUDIO INPUT IMPEDANCE—600 ohms.
AUDIO INPUT LEVEL—Approximately zero decibels.
FREQUENCY RESPONSE—Within $1\frac{1}{2}$ Db. of standard 75 microsecond pre-emphasis curve.
DISTORTION—Maximum $1\frac{1}{2}\%$ 50-100 cycles, less than 1% above 100 cycles.
NOISE LEVEL—60 Db. below 100% modulation FM.
50 Db. below 100% modulation AM.
TUBE COMPLEMENT—Two 4-125A Final Amplifiers; one 815 Intermediate Power Amplifier; one 815 Frequency Multiplier; one 6V6 Frequency Multiplier; nine 6SJ7 Frequency Multipliers and Amplifiers; one GL2H21 Modulator; one 6SJ7 Buffer Amplifier; one 6SJ7 Oscillator; two 6SN7 Audio Amplifiers; two 8008 Rectifiers; two 5Z3 Rectifiers.
POWER INPUT—1375 watts, approximately.
POWER SOURCE—220/115 volts 60 cycle single phase.
DIMENSIONS—78 inches high, 36 inches wide, 26 inches deep.
Approximately 1000 cu. ft. boxed for export shipment.
WEIGHT—Net approximately 1200 lbs.
Gross packed for export, approximately 1500 lbs.

BF-250A Transmitter—Complete with two sets tubes, two crystals and oven. Code ZADOS.

SALES OFFICES

123 Hampshire
Quincy, Illinois

40 Exchange Place
New York 5, N. Y.

in other sections of the United States
Distributors are conveniently located



GATES RADIO COMPANY
MANUFACTURERS, ENGINEERS, SINCE 1922
QUINCY, ILLINOIS, U.S.A.

GATES
TRANSMITTING EQUIPMENT
ALL OVER THE WORLD

MODEL BF-1A FM BROADCAST TRANSMITTER



One Kilowatt Power

Approved by the FCC

GATES RADIO COMPANY
MANUFACTURERS, ENGINEERS, SINCE 1922
QUINCY, ILLINOIS, U.S.A.

www.americanradiohistory.com

GATES
TRANSMITTING EQUIPMENT
ALL OVER THE WORLD

THE BF-1A transmitter is designed to provide a frequency modulated output having a nominal power rating of one thousand watts.

Complete attention has been given to ease of adjustment and maintenance of this equipment to assure excellent operation at all times even when used by personnel not formerly well acquainted with FM apparatus. Users of Gates FM equipment are also offered the complete facilities of our engineering department in the solving of installation problems. Experiments are constantly conducted here in our laboratories on station W9XLZ with the view of solving various problems that are and will be encountered in the field.

**Complete 1000-Watt
Equipment**

Consists of the BF-250A transmitter which together with a 1000 watt amplifier constitutes the BF-1A, 1000 watt transmitter. The BF-250A is the basic equipment used with all Gates higher powered FM transmitters and contains the phase shift modulation system, the crystal oscillator, frequency multiplier

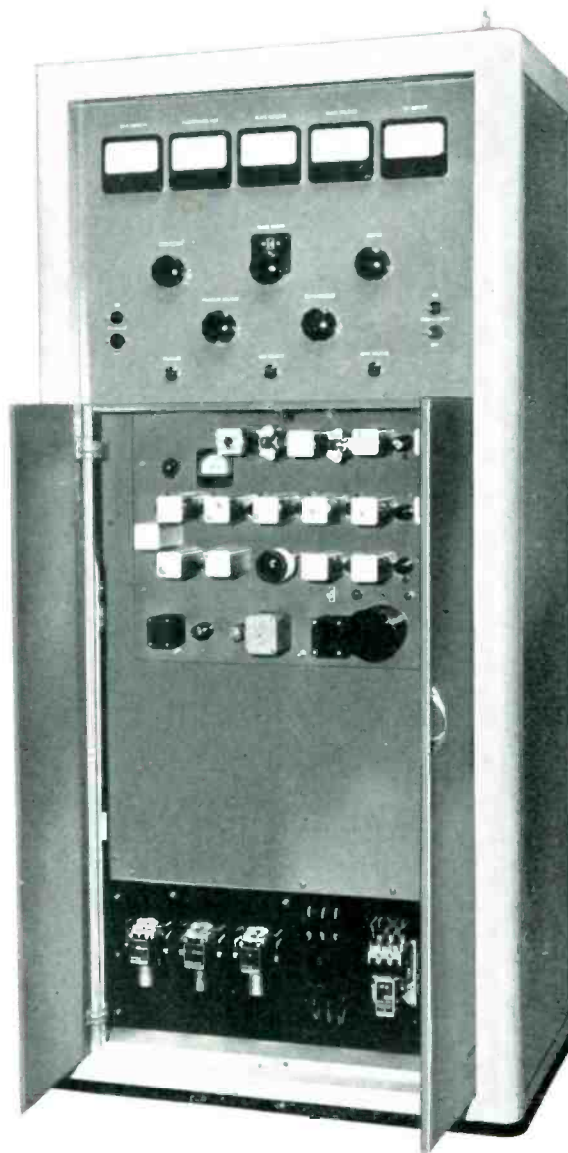

The cabinet above is the BF-250A 250-watt FM transmitter which is used as the exciter for driving the 1000 watt amplifier of the BF-1A transmitter. The BF-250A is a complete transmitter and may be installed first and the 1000 watt amplifier added later to obtain full power.

GATES RADIO COMPANY
MANUFACTURERS, ENGINEERS, SINCE 1922
QUINCY, ILLINOIS, U.S.A.

GATES TRANSMITTING EQUIPMENT ALL OVER THE WORLD

stages and a 250 watt power amplifier. It is, in itself, a complete transmitter and may be installed as the start of your FM transmitter installation and additional power secured by adding higher powered amplifiers. The BF-1A transmitter thus consists of two cabinets of equipment, each complete with power supply and control components. Circuit adjustments are not disturbed when adding the 1 KW amplifier as the output of the 250 watt portion and the input of the 1 KW amplifier are both designed for the same operating impedance. Therefore, if the BF-250A has been installed first all that is necessary to couple the 1 KW amplifier on is to disconnect the BF-250A from the transmission line and connect it to the protruding stub of line on the top of the 1 KW cabinet. Appearance harmony has been achieved thru identical cabinet design, same size and type of meters and symmetrical control arrangement.

Components

In the BF-1A

are of the finest quality. The names of their

suppliers are a veritable "Who's Who" in the component parts field. Further discrimination is evidenced by selecting only the best units

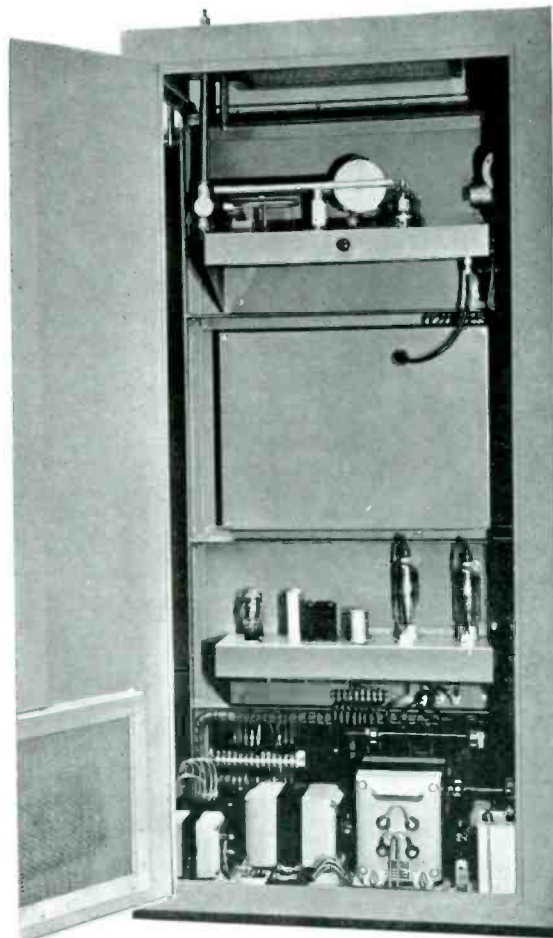

This is the rear view of the 250 watt portion of the BF-1A. The dust cover of the exciter unit in the center of the illustration can be easily removed for exposure of all components. Excitation is carried from the power stage of this cabinet to the grid circuit in the 1000 watt cabinet by a short section of coaxial cable.

GATES RADIO COMPANY
MANUFACTURERS, ENGINEERS, SINCE 1922
QUINCY, ILLINOIS, U.S.A.

GATES
TRANSMITTING EQUIPMENT
ALL OVER THE WORLD

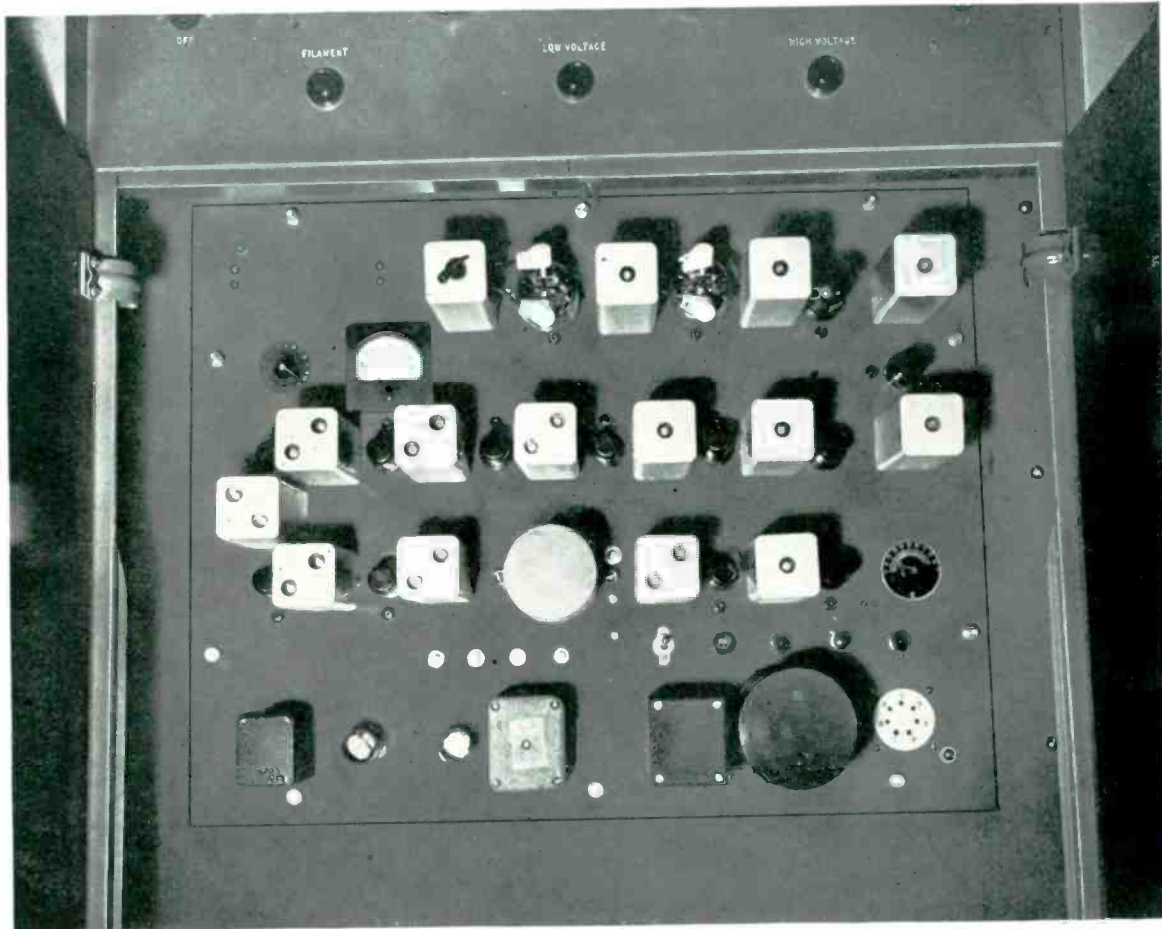

The exciter section shown above, located in the 250 watt cabinet, is the heart of all Gates FM transmitters. In the second row of components, inside the round shield is the 6L-21121 tube which performs the modulation. The modulation inductance is built inside the shield and comes off with it to facilitate tube replacements. The blank socket in the lower right corner accommodates a spare crystal and holder identical to the regular one shown in place adjacent to it.

made by such companies, emphasizing conservative ratings and proper design for the specific function. This is very important in FM apparatus as small factors contribute in

large amounts to the success of the operation. Many parts are also made in our own factory. Namely, the RF inductances and associated parts that function directly in the production

GATES RADIO COMPANY
MANUFACTURERS, ENGINEERS, SINCE 1922
QUINCY, ILLINOIS, U.S.A.

GATES
TRANSMITTING EQUIPMENT
ALL OVER THE WORLD

of the FM circuits. These require precision machining, careful plating and exact mechanical placement to achieve the required results.

Circuit Function

in the BF-1A is simplicity itself. Approximately 100 watts power is supplied from the BF-250A to excite the grids of the two type 4X500F tubes used in the 1 KW amplifier. This power is fed to the 1 KW amplifier thru a low impedance transmission line terminated in a small inductance. This inductance is mounted close to one of somewhat larger proportions that serves as the grid tank. The grid tank has both a shorting bar and a small vernier capacitor, the latter adjustable from the front panel, to secure both large and small tuning adjustments over the entire FM broadcast band. The plate tank is similarly arranged with the additional feature of having the output link mechanically movable from the front panel so that loading can be easily accomplished. A faraday screen is placed between the plate tank and the movable link to secure uniform loading on the final amplifier tubes. A small inductance is also used to pick

up a small amount of RF energy to operate the meter indicating RF output power.

The tubes in the amplifier are mounted directly into the top ends of the metallic tubes used as the plate tank inductance and are cooled by two blowers, one of which is at the bottom of each tank inductance tube. Air flow is at about six times the minimum rate necessary for average operation. The blower design is

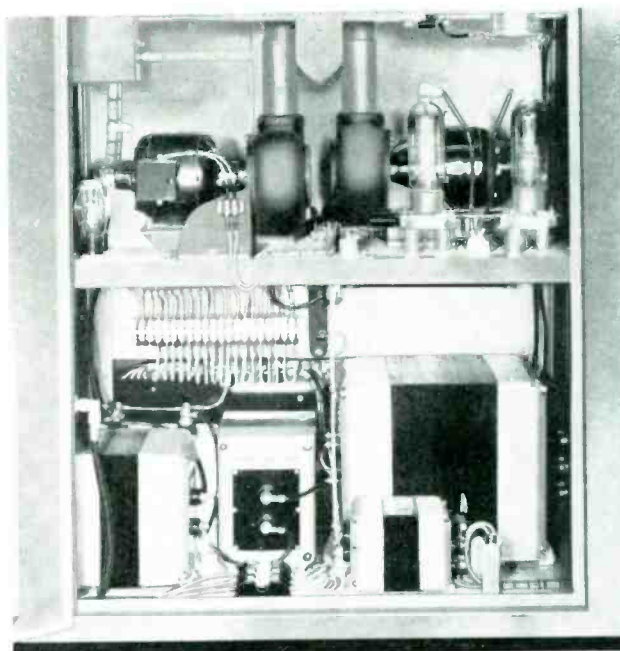

This view of the back of the 1000 watt amplifier in the BF-1A shows the generously proportioned power components. In the upper part of the illustration are shown the individual blowers which force air up past the power amplifier tubes.

GATES RADIO COMPANY
MANUFACTURERS, ENGINEERS, SINCE 1922
QUINCY, ILLINOIS, U.S.A.

GATES TRANSMITTING EQUIPMENT ALL OVER THE WORLD

such that the sound level is barely detectable in a quiet room.

Safety devices include an overload relay, time delay relay, thermal overload switches in the primary side of the filament and high voltage circuits and interlocks on front and back doors. Fuses are provided in the incoming power circuit. Meters are provided for filament and plate voltage and grid, plate and RF output current indication. A specially developed vacuum tube voltmeter circuit is used in conjunction with the latter meter. All meters are 4 inch size.

Controls . . .

are on the front panel to accomplish most adjustments. In addition to push-button stations for starting and stopping the filament and plate circuits; neutralizing, grid tuning, plate tuning and output loading are also adjustable from the front. The last three have counters that make returning to and recording of settings a simple matter. Pilot lights are provided to show when filament, low voltage and high voltages are in operation.

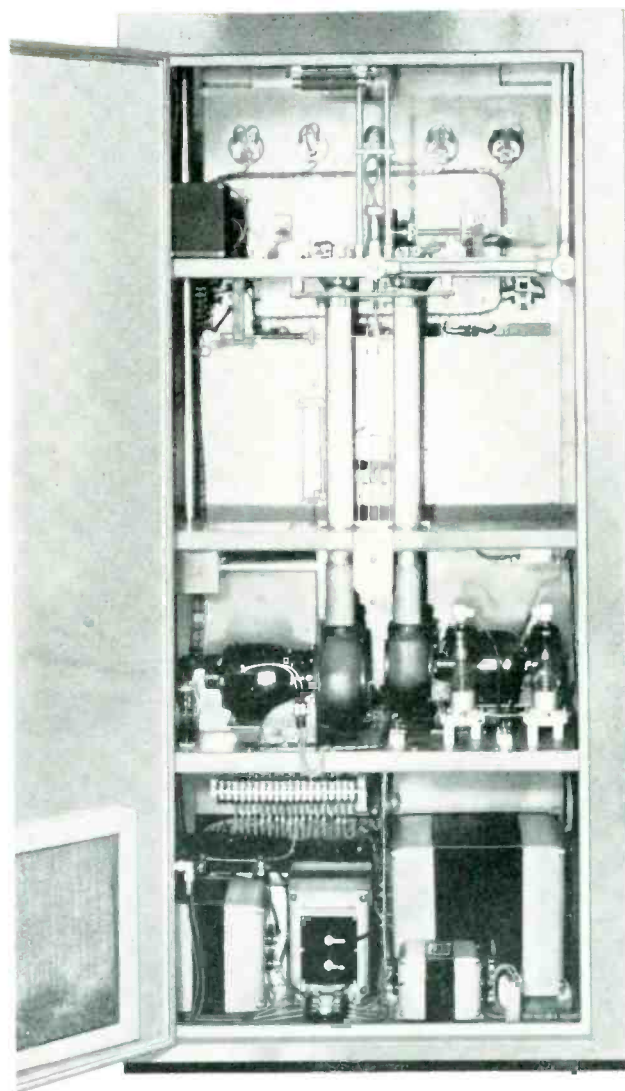

This is a full view of the 1000 watt amplifier portion of the BF-1A transmitter. Two blowers force many times the required amount of air necessary up past the power amplifier tubes. Still they are so quiet that announcing can easily be done in the same room.

GATES RADIO COMPANY
MANUFACTURERS, ENGINEERS, SINCE 1922
QUINCY, ILLINOIS, U.S.A.

GATES TRANSMITTING EQUIPMENT ALL OVER THE WORLD

Appearance

is certainly present to a pleasing degree in the BF-1A. In addition to styling and arrangement of controls care has been taken in finishing each part to provide showmanship to the station. The cabinet is made of first quality furniture steel finished with a multi-coat two-tone enamel, hand rubbed and polished. It is easy to keep clean and will retain its original luster for years.

Accessory Equipment

in any broadcasting station plays a large part in the success of the installation. The proper selection of it is also an important step. Gates has been known for 25 years as a manufacturer of high quality audio equipment for studios and remote work and also manufactures recording and transcription equipment. Excellent relations are maintained with suppliers of antennae, support towers, coaxial cable and the many other units necessary in any FM installation to the point where Gates can handle

your complete supply problem more thoroughly and quickly than any other single source. The services of competent sales engineers are at your disposal in selecting the equipment to best fit your needs.

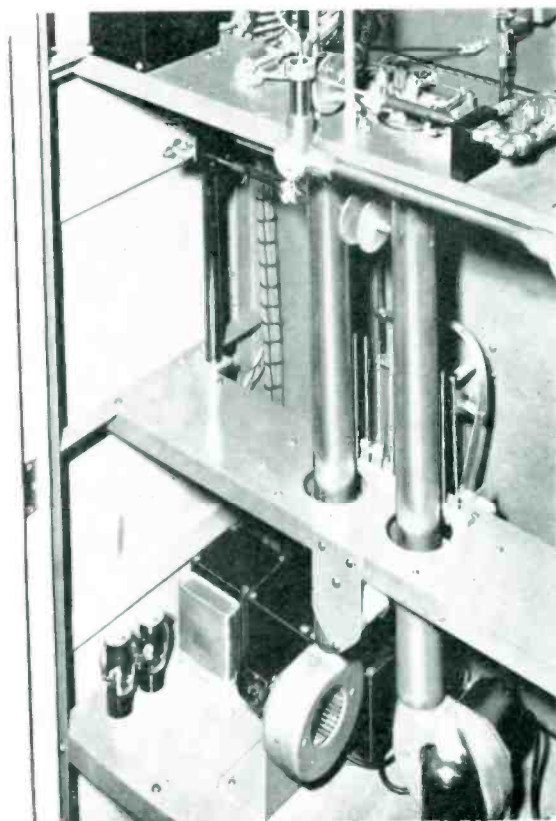

The two vertical pipes in this illustration are the final amplifier tank inductance. The power tubes are mounted at the top and set down in the pipes. The faraday shield just back of the tank circuit is used to equalize the loading on the final stage tubes.

GATES RADIO COMPANY
MANUFACTURERS, ENGINEERS, SINCE 1922
QUINCY, ILLINOIS, U.S.A.



TRANSMITTING EQUIPMENT

SPECIFICATIONS

POWER OUTPUT—1000 watts.
FREQUENCY RANGE—88 to 108 megacycles.
RF OUTPUT IMPEDANCE—40-80 ohms.
TYPE OF OSCILLATOR—Direct Crystal Control (In BF-250A).
FREQUENCY STABILITY—250 cycles.
TYPE OF MODULATION—Phase shift.
MODULATION CAPABILITY—100 kilocycles.
AUDIO INPUT IMPEDANCE—600 ohms.
AUDIO INPUT LEVEL—Approximately zero decibels.
FREQUENCY RESPONSE—Within 1½ decibels of standard 75 microsecond pre-emphasis curve.
DISTORTION—Maximum 1½% 50-100 cycles, less than 1% above 100 cycles.
NOISE LEVEL—60 Db. below 100% modulation FM.
50 Db. below 100% modulation AM.
TUBE COMPLEMENT—Two 4-125A Final Amplifiers; one 815 Intermediate Power Amplifier; one 815 Frequency Multiplier; one 6V6 Frequency Multiplier; nine 6SJ7 Frequency Multipliers and Amplifiers; one GL2H21 Modulator; one 6SJ7 Buffer Amplifier; one 6SJ7 Oscillator; two 6SN7 Audio Amplifiers; two 8008 Rectifiers; two 5Z3 Rectifiers (In BF-250A portion); two 4X500 Final Amplifiers; two 5Z3 Low Voltage Rectifiers; two 8008 High Voltage Rectifiers; one 6H6 for RF output VTVM.
POWER INPUT—Approximately 3875 watts.
POWER SOURCE—220/115 volts, 60 cycle, single phase.
DIMENSIONS—Two cabinets, each 78 inches high, 36 inches wide, 26 inches deep. Approximately 2000 cu. ft. boxed for export shipment.
WEIGHT—Net, approximately 3200 lbs.
Gross, packed for export, approximately 3700 lbs.

BF-1A Transmitter—Complete with two sets of tubes, two crystals and ovens.
Code ZAEWK.

SALES OFFICES

123 Hampshire St.
Quincy, Illinois

1350 North Highland Ave.
Hollywood 28, California

40 Exchange Place
New York 5, N. Y.

Distributors are conveniently located
in other sections of the United States



GATES RADIO COMPANY

MANUFACTURERS, ENGINEERS, SINCE 1922
QUINCY, ILLINOIS, U.S.A.

GATES
TRANSMITTING EQUIPMENT
ALL OVER THE WORLD

MODEL BF-3A

3 KW. FM BROADCAST TRANSMITTER



Approved by the FCC

GATES RADIO COMPANY
MANUFACTURERS, ENGINEERS, SINCE 1922
QUINCY, ILLINOIS, U.S.A.

www.americanradiohistory.com

GATES

TRANSMITTING EQUIPMENT

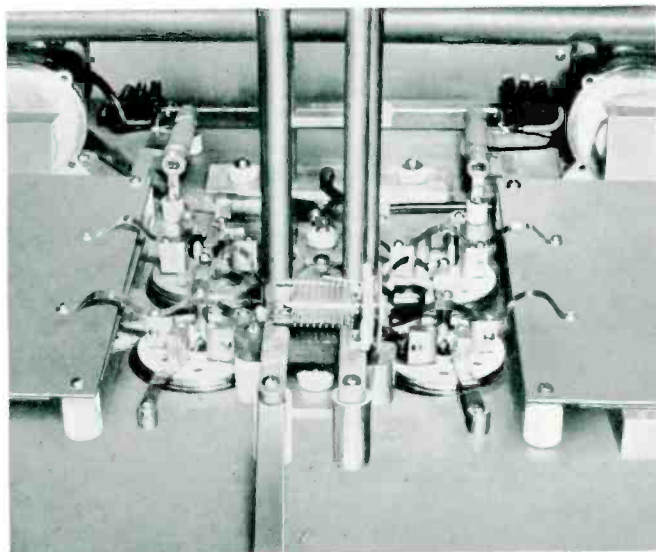

Above is a closeup of the final amplifier. Four type 4X500F tubes are used to develop 3 kilowatts power. The neutralizing capacitors, located on either side of the tubes are operated by two low speed motors and a cam arrangement. Control is from the front panel.

HERE is a three kilowatt FM transmitter that is easy and economical to operate, time tested under operating conditions and incorporating the finest materials and workmanship.

This unit may well be the focal point of a 100% Gates integrated installation as all finishes, architecture and electrical parameters are to match other Gates equipment elements generally associated in a three kilowatt FM installation.

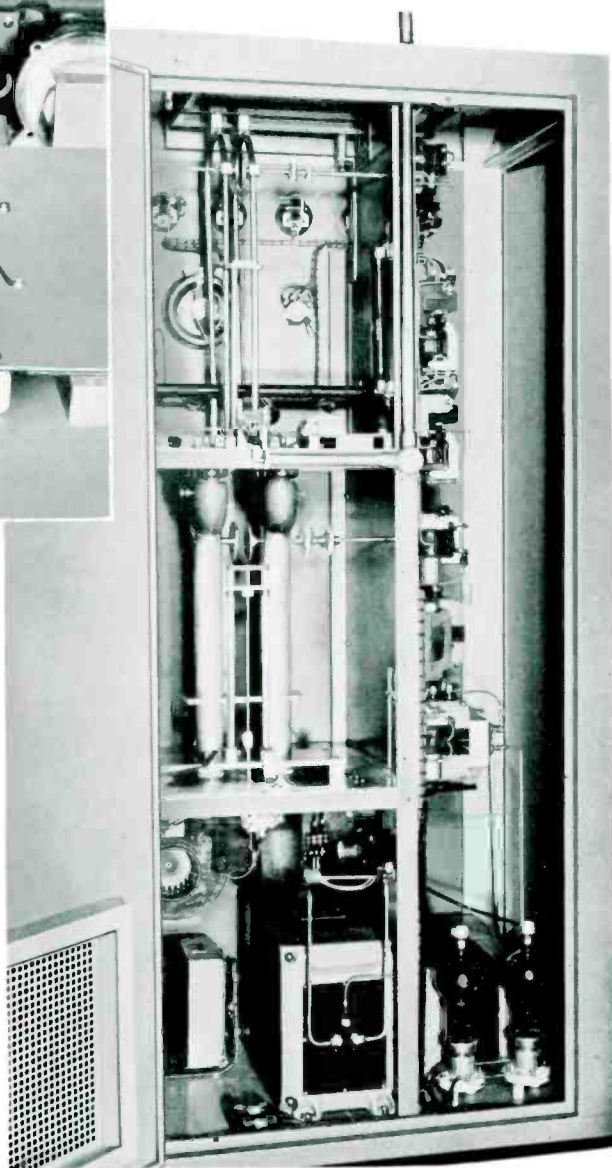

The back of the BF-3A is fully exposed when the rear door is opened. At the top is the $\frac{3}{4}$ wave length grid tank. Power tubes are located on the top shelf and set into the vertical pipes directly below, which are the final tank circuit. The two blowers exhaust air into these pipes to cool the tubes.

GATES RADIO COMPANY
 MANUFACTURERS, ENGINEERS, SINCE 1922
 QUINCY, ILLINOIS, U.S.A.

GATES
TRANSMITTING EQUIPMENT
ALL OVER THE WORLD

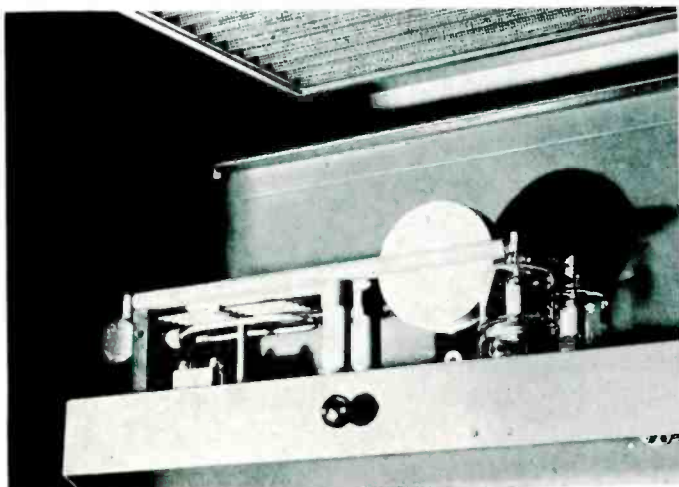

On the left is the power amplifier in the 250 watt exciter which supplies driving power for the grids of the 3 kilowatt amplifier. Two type 4-125A tubes are used.

**THE
CIRCUIT**

of the BF-3A is quite simple. It uses phase shift modulation and direct crystal frequency control. A GL-2H21 vacuum tube is used as a modulated amplifier. The signal is multiplied in frequency and power by several stages and is fed to the grids of four 4X500F power amplifier tubes operated in push-pull parallel. These supply three kilowatts power to a $1\frac{5}{8}$ inch coaxial cable output which matches standard 51 ohm transmission lines used to feed FM antennae.

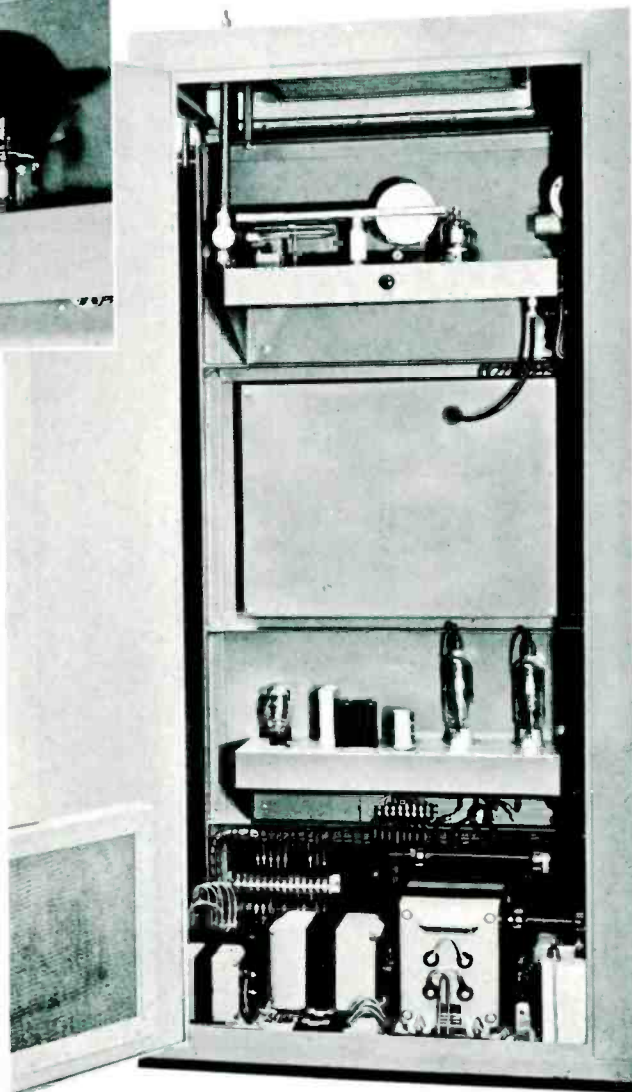

Above is the rear view of the 250 watt exciter. This cabinet and the one on the opposite page ordinarily set side by side to form the complete BF-3A three kilowatt FM transmitter.

GATES RADIO COMPANY
MANUFACTURERS, ENGINEERS, SINCE 1922
QUINCY, ILLINOIS, U.S.A.

GATES TRANSMITTING EQUIPMENT ALL OVER THE WORLD

All of the apparatus is completely contained in two cabinets; one of which is a complete 250 watt transmitter (the BF-250A) and the other being the three kilowatt power amplifier complete with self-contained power amplifier and control circuits. If desired, the 250 watt portion may be operated independently facilitating its installation first for use

as a 250 watt station and then adding the three kilowatt amplifier at a later date when additional power is required.

At the right is the front view of the exciter unit with the doors open. In the center is the modulator and frequency multiplier section. This portion is shown in more detail below. The meter may be connected into any plate circuit by means of the switch. One crystal holder is shown in position beside the empty socket intended for the second crystal.

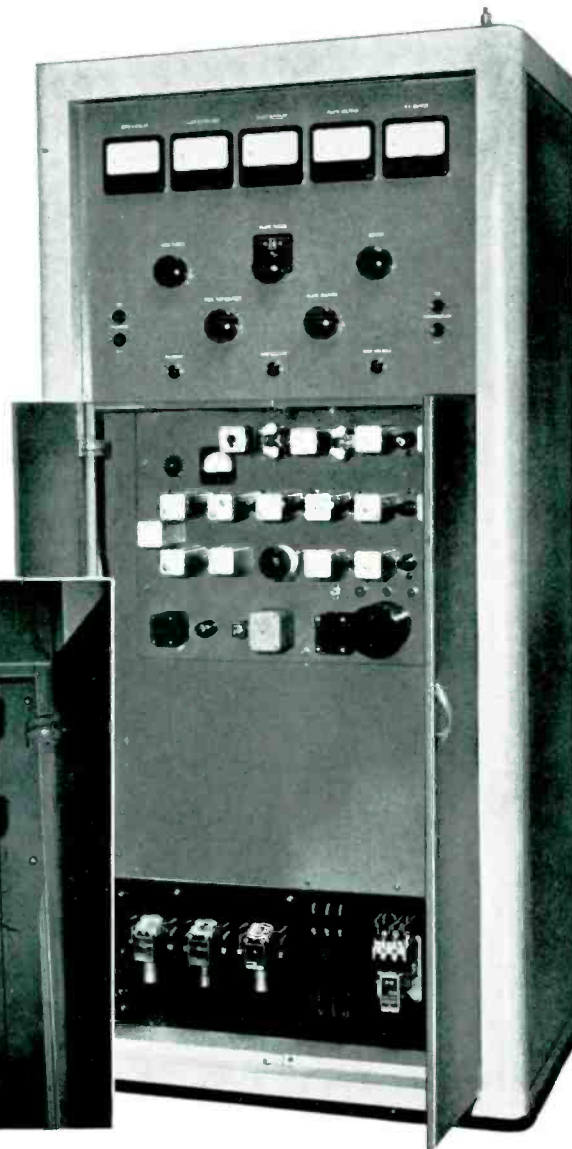
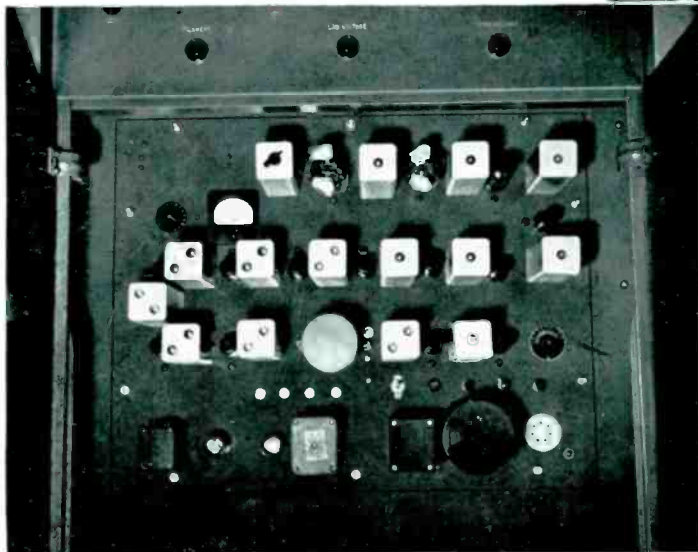

GATES RADIO COMPANY
MANUFACTURERS, ENGINEERS, SINCE 1922
QUINCY, ILLINOIS, U.S.A.

GATES
TRANSMITTING EQUIPMENT
ALL OVER THE WORLD

**TECHNICAL
REFINEMENTS**

in the BF-3A transmitter have been chosen to make it operate better and longer and eliminate complicated innovations that are of doubtful value and performance.

One of the outstanding features is the $\frac{3}{4}$ wave length grid tank in the power amplifier which makes this stage very easy to drive as more efficient coupling is thereby obtained. Tests show that only a portion of the available power from the driver stage is necessary to obtain full output power. Furthermore, efficiencies of better than 70% are realized in actual operation. Chances of accidental overload of power tubes has been reduced to a minimum by incorporating fast action circuit breakers and relays in all important places. In particular, one of them is in the grid circuit of the power amplifier and if drive fails or is reduced close to minimum requirements the plate and screen voltages are removed from the tubes.

When the right side panel is removed the complete control circuit and power supply units of the three kilowatt amplifier are exposed. All of these components may also be reached from the back. The blower located just above center provides forced air circulation on the filament seals of the power amplifier tubes.

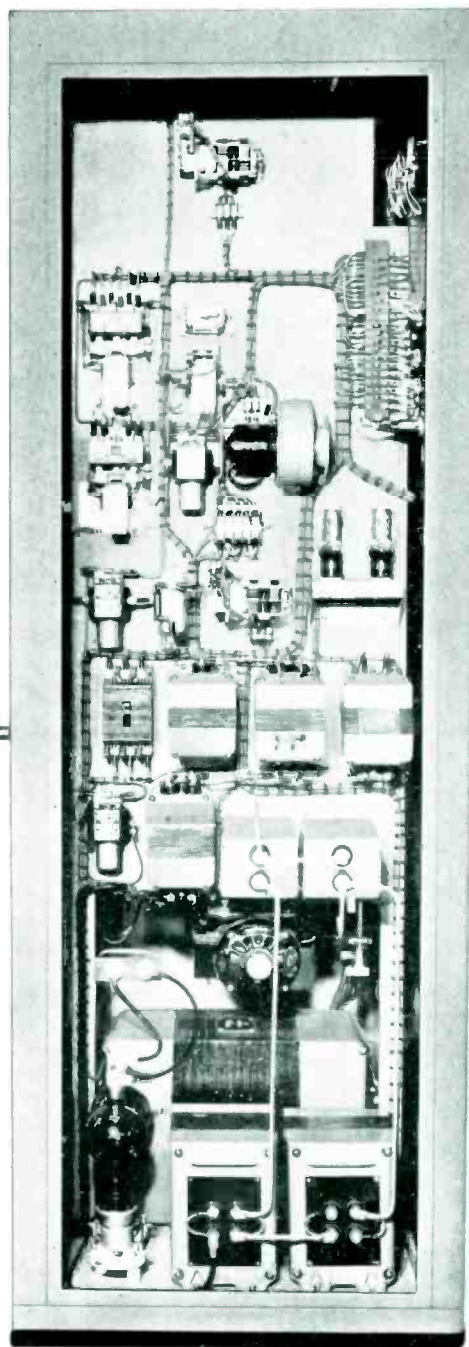

GATES RADIO COMPANY
MANUFACTURERS, ENGINEERS, SINCE 1922
QUINCY, ILLINOIS, U.S.A.

GATES
TRANSMITTING EQUIPMENT
ALL OVER THE WORLD

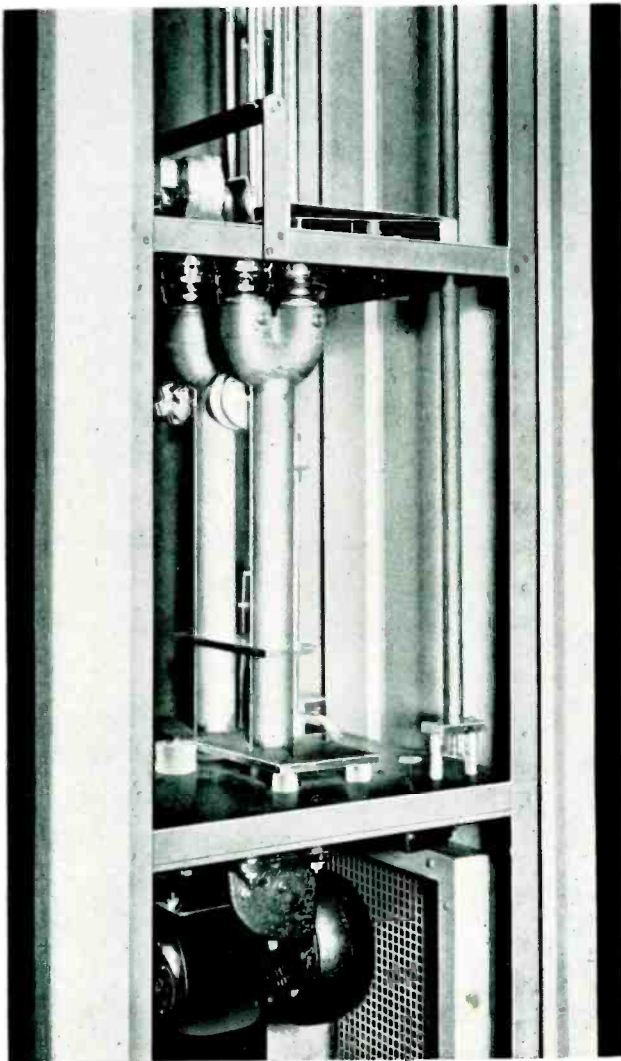

This view shows the plate tank section of the three kilowatt amplifier. All portions of this as well as other sections of the transmitter are carefully plated and mechanically arranged to secure high efficiency.

Ventilation has had particular attention in the BF-3A design. Both cabinets are insect proof and have air inlet filters at the bottom and outlet filters at the top. They are all of the type that can be easily cleaned in the field and used for years. Forced air is directed against all filament seals of the power amplifier tubes. In addition, air is blown up thru the plate tank of the power amplifier and the ventilating fins of each tube to dissipate heat and insure long tube life. The blowers are especially designed to provide large quantities of air at such a low noise level that open microphones can be used in the same room without difficulty.

METERING

is provided throughout the entire transmitter. In the 250 watt driver four

GATES RADIO COMPANY
MANUFACTURERS, ENGINEERS, SINCE 1922
QUINCY, ILLINOIS, U.S.A.

TRANSMITTING EQUIPMENT



inch meters indicate grid current, filament voltage, plate current, plate voltage and transmission line current for the 250 watt power amplifier.

The low power and multiplier stages plate currents are shown by a meter mounted on the exciter unit which can be switched into any desired circuit. Meters for the three kilowatt amplifier are also four inch and indicate grid, plate and RF output currents and plate and filament voltages. A vacuum tube voltmeter arrangement is used to indicate RF output.

CABINET CONSTRUCTION

is sturdy and rigid with ample reinforcement to support all components. The exterior is made of the finest furniture steel finished in three tone

gray enamel highly polished and waxed. It is truly a show-piece and will fit into the decoration scheme of any installation.

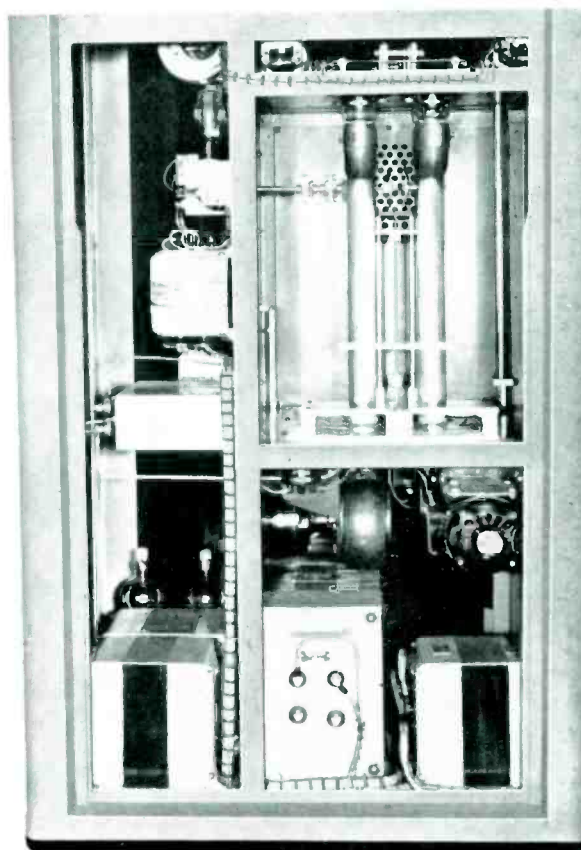

This is approximately the bottom half of the three kilowatt cabinet showing the large power components, blower and plate tank components.

GATES RADIO COMPANY
MANUFACTURERS, ENGINEERS, SINCE 1922
QUINCY, ILLINOIS, U.S.A.





TRANSMITTING EQUIPMENT

SPECIFICATIONS

POWER RANGE—3000 watts nominal rating.
FREQUENCY RANGE—88 to 108 megacycles.
RF OUTPUT IMPEDANCE—40-80 ohms.
TYPE OF OSCILLATOR—Direct crystal control.
FREQUENCY STABILITY— ± 250 cycles.
TYPE OF MODULATION—Phase shift.
MODULATION CAPABILITY—100 kilocycles.
AUDIO INPUT IMPEDANCE—600 ohms.
AUDIO INPUT LEVEL—Approximately zero decibels.
FREQUENCY RESPONSE—Within $1\frac{1}{2}$ Db. of standard 75 microsecond pre-emphasis curve.
DISTORTION—Maximum $1\frac{1}{2}$ 50-100 cycles, less than 1% above 100 cycles.
NOISE LEVEL—60 Db. or more below 100% modulation FM.
50 Db. or more below 100% modulation AM.
TUBE COMPLEMENT—Four type 4X500F Final power amplifiers; two 4-125A Driver amplifiers; one 815 intermediate power amplifier; one 815 frequency multiplier; one 6V6 frequency multiplier; nine 6SJ7 frequency multipliers and amplifiers; one GL2H21 Modulator; one 6SJ7 Buffer amplifier; one 6SJ7 Oscillator; two 6SN7 Audio amplifiers; two 8008 rectifiers; two 5Z3 Rectifiers; two type 575A main rectifiers; two type 5Z3 screen voltage rectifiers.
POWER INPUT—Approximately 6250 watts.
POWER SOURCE—220/115 volts 60 cycle single phase.
DIMENSIONS—Each cabinet 78 inches high, 36 inches wide, 26 inches deep.
Approximately 2000 cubic feet total packed for export.
WEIGHT—Net, approximately 3500 lbs.
Gross. packed for export approximately 4400 lbs.

BF-3A—FM Broadcast Transmitter with two sets of tubes and two crystals and ovens. Code ZAGIT.

SALES OFFICES

123 Hampshire St.
Quincy, Illinois

1350 North Highland Ave.
Hollywood 28, California

40 Exchange Place
New York 5, N. Y.

Distributors are conveniently located
in other sections of the United States.



GATES RADIO COMPANY

MANUFACTURERS, ENGINEERS, SINCE 1922
QUINCY, ILLINOIS, U.S.A.

GATES
TRANSMITTING EQUIPMENT
ALL OVER THE WORLD

High Frequency Communications or Broadcast Transmitter



1000 Watts Telephone and Telegraph 2-22 Mc.
Model HF 1-2 (High Fidelity)

GATES RADIO COMPANY
MANUFACTURERS, ENGINEERS, SINCE 1922
QUINCY, ILLINOIS, U.S.A.

www.americanradiohistory.com

TRANSMITTING EQUIPMENT

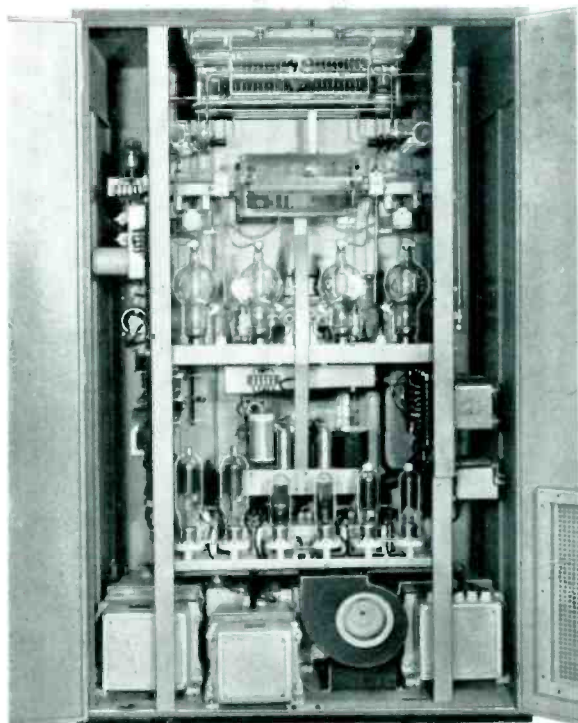

Fig. 1—Rear View

THE Model HF 1-2 radio transmitter is for both telegraph and high quality audio or telephone transmission. It has been designed so that it may be used for short wave broadcasting of music as well as voice and thus it may be used for either commercial communications or short wave broadcasting.

The electrical and mechanical construction of the HF1-2 transmitter provides satisfactory operation under a temperature range of from -18° to $+60^{\circ}$ C. with humidities up to 90%. The use of a high speed pressure blower system with complete inlet and outgo filtering results in a high degree of insect proofing and freedom from dirt. Convenient access to any part of the HF1-2 transmitter is afforded as the open views of the equipment demonstrate. Maintenance time is kept to a minimum due to complete accessibility of all parts.

The MO2606 or MO2606A multi frequency exciter is employed as the oscillator-first buffer stage. This is fully described on a separate catalog bulletin as having five pre-set crystal frequencies and complete frequency coverage from 2-22 Mc. without changing a coil and in split second time. In Figure 3 the lower panel illustrates the exciter unit. Above the exciter unit is the second intermediate amplifier which is a push pull 813 stage offering an abundance of grid drive to the final power amplifier at all frequencies. The final power amplifier is also push pull utilizing 450TH tubes which feed into a balanced to ground transmission line from 400 to 800 ohms. Frequency change in the 2nd I.P.A. and the final power amplifier is by means of seven plug in coils in the I.P.A. and 5 latch on coils for the power amplifier. All higher frequency coils are silver plated and tarnish protected by clear water dip process. Uncommon features of the radio frequency section are grid drive balancing controls in the power amplifier stage, and dual power amplifier plate current meters.

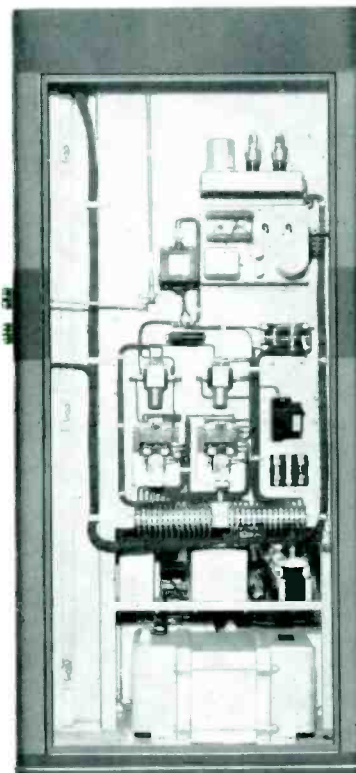

Fig. 2—Left Side

GATES RADIO COMPANY
 MANUFACTURERS, ENGINEERS, SINCE 1922
 QUINCY, ILLINOIS, U.S.A.

GATES
TRANSMITTING EQUIPMENT
ALL OVER THE WORLD

The audio section of the HF 1-2 transmitter has three stages and employs high level class B modulation. Fixed bias through a second Rectox bias supply is placed on both the push pull driver and modulator stages. All audio stages are push pull and modulators may be balanced by separate bias rheostats for each modulator tube. Very low noise and distortion content is had while frequency response is linear from 30 to 10,000 cycles. For communications service peaked audio frequency response may be had where ordered.

The power supply is in three sections; the first is the self contained power supply for the exciter unit, the second is full wave 872/872A tubes which supply the 2nd I.P.A. and all audio stages but the modulators and the third supply is full wave 575A tubes which supply final power amplifier and modulator tubes. Regulation is better than 5% at all degrees of modulation.

The cabinet enclosure is of heavy cold rolled steel with base plate of 1/8" stock for supporting all heavy transformers. Sides are removable, dual full length back doors are provided and a full length front door with hydraulic pull allows access to the exciter and I.P.A. tuning circuits. Tubes may be viewed through a double glass section. All tuning circuits, where required, are correctly located for electrical perfection and controlled by direct gear reduction drives. All circuits tune from the front including antenna resonating components. Finish is in light gray over the inside and lettering in black. Outside finish is in hand rubbed forest ebony green toned in black. Chassis and other conducting supports are copper plated.

As the HF 1-2 transmitter may be used for either communications or broadcast service, the purchaser should determine the allowable frequency tolerance when ordering. The MO2606 exciter unit which accommodates five crystals has a tolerance of .02% at normal room temperatures which is satisfactory for communications service though in actual service the drift is much less than this. For closer tolerances required in international short wave broadcasting service the MO2606A exciter may be had which uses two temperature control crystal ovens holding the drift to .005% regardless of room temperature.

Keying where required is in the cathode circuit of the oscillator stage and is by means of a high speed keying relay operated by a small 12 volt Rectox rectifier assuring close tracking and noiseless operation of the relay coil. Relay protection is complete including primary circuit breakers, filament and plate contactors, overload relay and time delay relay. Start-stop circuits are controlled by push buttons and terminals are provided for extension circuits where the transmitter is located some distance from the operating point.

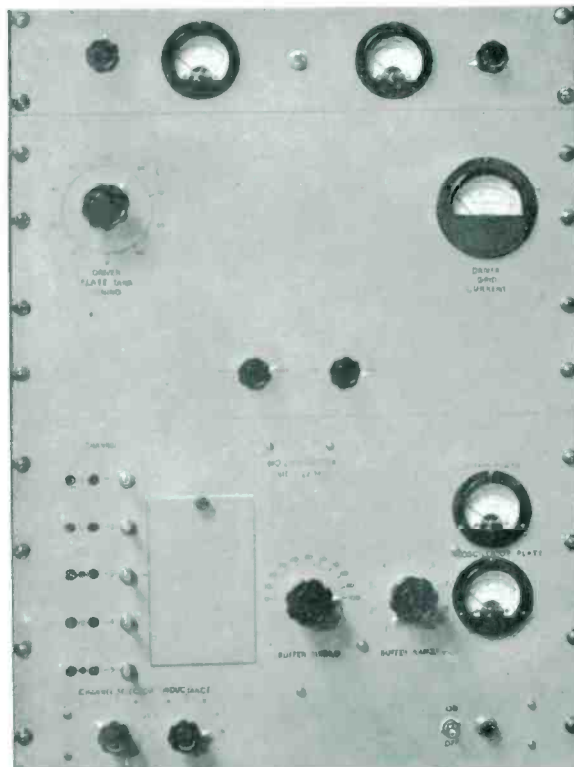

Fig. 3—OSC.-I.P.A. Section

GATES RADIO COMPANY
MANUFACTURERS, ENGINEERS, SINCE 1922
QUINCY, ILLINOIS, U.S.A.



TRANSMITTING EQUIPMENT

SPECIFICATIONS

Cabinet size—78" high, 48" wide and 36" deep.

Weight packed—3053 lbs.

Cubage packed—275.

Power output—2-18 Mc. 1000 watts. 18-22 Mc. 900 watts.

Frequency range—2-22 Mc.

R.F. Output impedance—400 to 800 ohm. balanced line.

Metering—Osc. plate, 1st I.P.A. plate, second I.P.A. grid, 2nd I.P.A. plate, pwr. amplifier grid, power amplifier plate (2 meters), filament volts, plate volts, modulator plate and audio driver plate.

Power consumption—Telegraph 4000 watts, telephone 5250 watts.

Frequency response—30-10,000 cycles within plus or minus 2 Db.

Distortion—5% or less at 100% modulation.

Power input—230 volts 50-60 cycles grounded neutral.

Audio input level—Plus 4 V.U. for 100% modulation.

Keying—60 words per minute.

Tubes used—Two 807, one 5Z3, two 813, four 450th, two 845, two 6A5G, two 872-872A and two 575A.****

Operating cycles—Continuous.

Operating conditions—All climates.*

Crystal frequencies—As ordered.**

Frequency tolerance—.02% communications, .005% broadcast. (See preceding data.)***

* Does not indicate complete fungus treatment.

** Crystals and holders not supplied with transmitter and must be ordered separately.

*** As ordered.

**** Tubes not supplied and must be ordered separately.

Model HF 1-2 Telephone and Telegraph Transmitter Code Word—YUREF.

GATES
TRANSMITTING EQUIPMENT
ALL OVER THE WORLD

MODEL HF-8 HIGH FREQUENCY TRANSMITTER

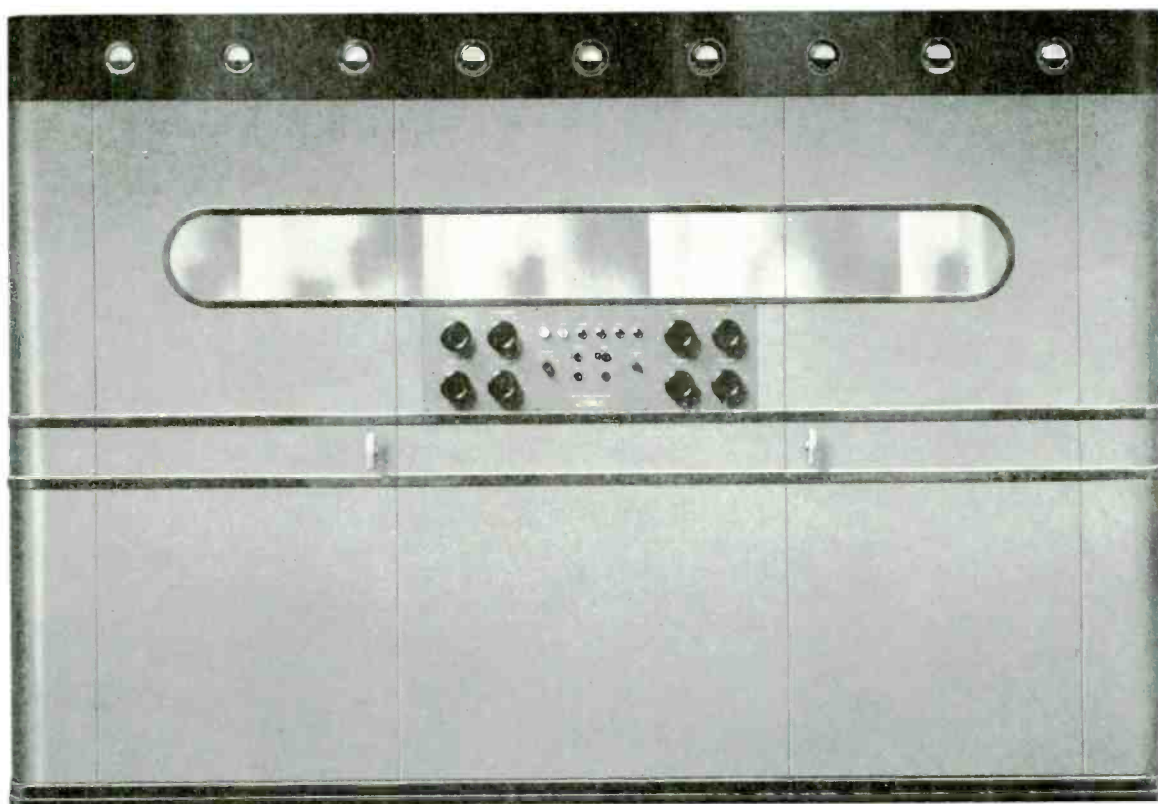

The HF-8 Transmitter is offered to the international communications field to fill high fidelity broadcasting requirements or general communication applications where both radio telephone and high speed radiotelegraph circuits are employed. It has eight kilowatts power output over its frequency range of two to twenty megacycles.

GATES RADIO COMPANY
MANUFACTURERS, ENGINEERS, SINCE 1922
QUINCY, ILLINOIS, U.S.A.

TRANSMITTING EQUIPMENT

Every control is easy to reach and operate in the HF-8 transmitter. Tuning controls are on the panels behind the right door and on the center panel; relays, contactors and power changing switches behind the left door. The entire transmitter can be operated with the doors open to facilitate the making of adjustments. No dangerous potentials are exposed.

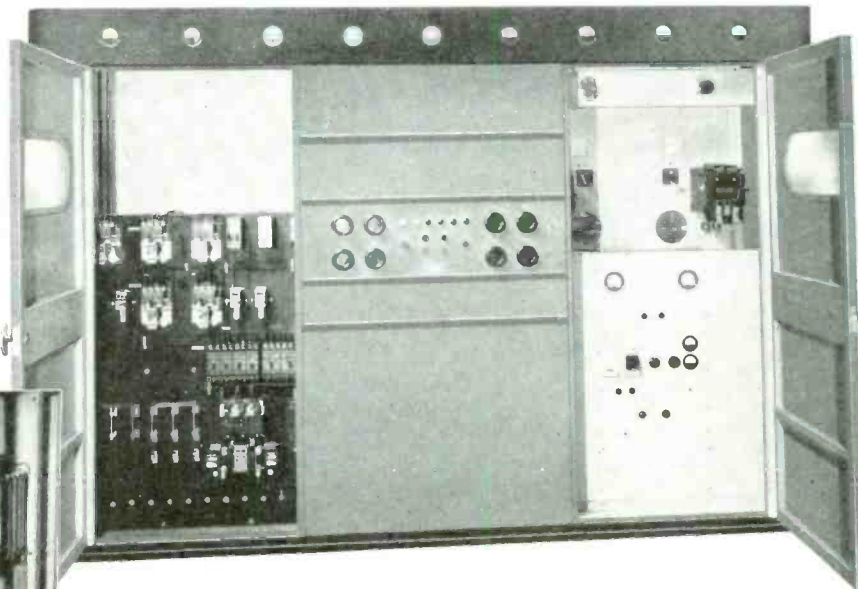

The modulator typifies the open manner of construction used throughout the HF-8 transmitter. Every part is easy to examine and maintain.

the R.F. output unit which consists of two large air-cooled tubes, the plate inductor, neutralizing capacitors, and the components that make up the pi-section output coupling assembly. All of the adjustments that are made at routine intervals are readily available either on the front panel or directly behind either door. Meters mounted across the front at the top are easily observed when tuning the higher level stages. Plate current meters for the oscillator and buffer stages are easily seen on the front panel of the MO-2606 frequency control unit. Directly behind the left front door is the control panel which contains all the relays and contactors necessary to the operation of HF-8 with exception of the surge resistor shorting contactor which by virtue of its function is better located in the rectifier unit. Behind the control panel is the modulator unit which consists of four push-pull stages.

GENERAL INFORMATION

Particular attention has been given to accessibility in the HF-8 transmitter. The Keyer Unit, MO-2606 Frequency Control Unit, and Second Buffer Stage are located directly behind the front door on a standard relay rack type assembly. Near the top are the two tuning controls for the output network assembly. In a section behind these assemblies is mounted

GATES RADIO COMPANY
 MANUFACTURERS, ENGINEERS, SINCE 1922
 QUINCY, ILLINOIS, U.S.A.

GATES TRANSMITTING EQUIPMENT ALL OVER THE WORLD

Ample band overlap is provided to assure simplification of tuning adjustments.

Frequency control for this section is obtained from the MO-2606 or MO-2606-A Frequency Control Units, either one of which is supplied at the customer's option. MO-2606 accommodates five non-temperature controlled crystals whereas MO-2606-A has two temperature controlled crystals, both on the same frequency, one in operation and the other for standby. Both models have an inductor and switch circuit and five trimmer capacitors associated with the oscillator tube for setting up the desired operating channel in the oscillator. The inductor is tapped in nine places, any one of which may be selected by means of the switch. The portion of the inductance selected is tuned by any one of the capacitors selected by their tap switch. Thus, it is possible to tune any portion of the inductance with any capacitor. By properly adjusting each capacitor to the desired frequencies when installing the unit, any five preset channels are readily available. Mechanically, the only difference between MO-2606 and MO-2606-A is the number of crystals that can be accommodated in each one. Electrically, they are identical. Examination of the catalog description of MO-2606 and MO-2606-A will supply operating details.

Selection of inductors for tuning the first amplifier stage is also done by a tap switch, very substantial mechanically, and having silver plated contacts to assure very low contact resistance at high frequencies. One tuning capacitor is used and adjusted properly whenever a change in frequency or inductors is made.

The second amplifier uses plug-in inductors and a common tuning capacitor for determining the frequency. This system is the most advantageous for this stage as it eliminates long leads and moving contacts to a great degree. High frequency R.F. currents are thus handled more efficiently.

Forced air cooling, nitrogen filled tuning capacitors, and quickly interchangeable in-

ductors are featured in the Final Power Amplifier stage of the HF-8 transmitter. The blowers supplying the forced air cooling for the final power amplifier tubes rotate at only 750 RPM, but supply ample air to maintain the tubes for below their maximum operating temperature. This slow speed operation eliminates vibration and prolongs tube and blower life.

Following the Final Power Amplifier is the Pi-network coupling section which enables matching the output to any conventional line or antenna.

RECTIFIER UNIT

All direct current power for the HF-8 transmitter is furnished by an externally located unit which contains all of the apparatus neces-

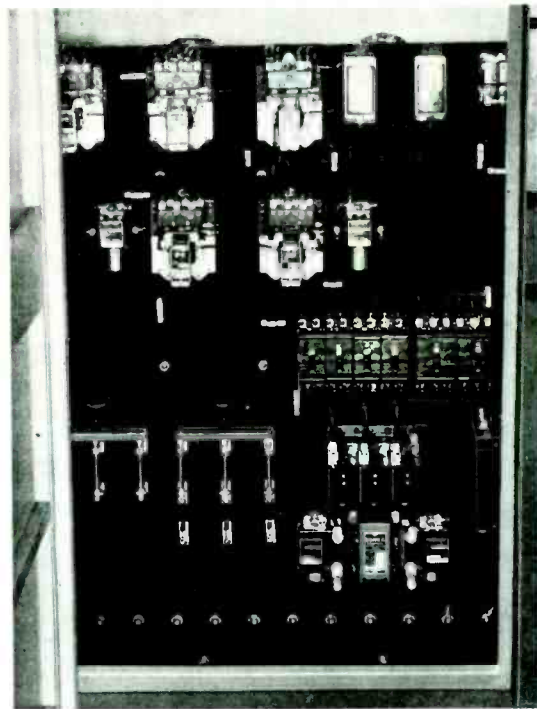

The main control panel, located directly behind the left front door, is very accessible for operational and maintenance purposes.

GATES RADIO COMPANY
MANUFACTURERS, ENGINEERS, SINCE 1922
QUINCY, ILLINOIS, U.S.A.

GATES

TRANSMITTING EQUIPMENT



Controls are clearly marked to enable easy adjustment and thus obtain the best results in the Hum Eliminator Amplifier.

The interior design of the Hum Eliminator Unit is simplicity itself. The modern circuit makes available cancellation on two hum frequencies.

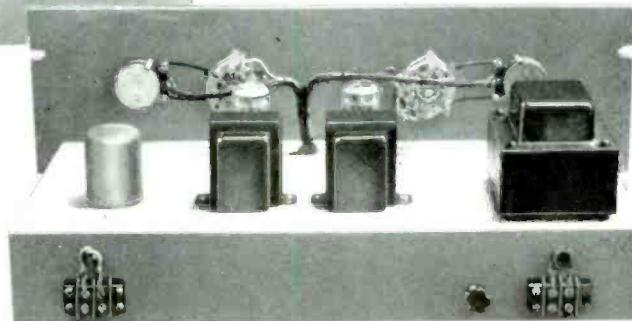

sary for changing alternating current to direct current for application to the plates of the tubes and for biasing purposes. Two large transformers, used to step up the alternating voltage, operate in conjunction with the rectifier and are located adjacent to it.

Mechanically the rectifier is a large angle iron framework holding three shelves of apparatus. The frame is welded together to secure maximum strength and rigidity and both the frame and shelves are copper plated to secure good electrical bonds.

External connections are made to terminal strips at the front.

CONTROL PANEL

The control panel contains the relays, switches, and contactors to perform the actual starting and power circuit connecting functions in the HF-8 transmitter. These components are arranged on a switchboard type panel located directly behind the left front door to permit ready accessibility. Sequence of operation is

automatic when set up by the front panel controls and has been so arranged that it is impossible to do any harm to the transmitter should the manual controls be manipulated out of proper order.

HUM ELIMINATION UNIT

Even though hum noise in the HF-8 is sufficiently below the program level for all practical purposes, additional reduction is possible by use of the MO-2613 Hum Elimination Unit which is furnished as part of the HF-8 equipment.

Regardless of the power source frequency, this unit generates two hum components that are equivalent in frequency to those predominate in the HF-8 transmitter and which may be accurately adjusted in phase and amplitude to cancel out those that occur in the transmitter.

This unit is contained on a relay rack mounting panel and chassis and is normally mounted in the rack with speech equipment associated with the transmitting equipment.

GATES RADIO COMPANY
 MANUFACTURERS, ENGINEERS, SINCE 1922
 QUINCY, ILLINOIS, U.S.A.

GATES TRANSMITTING EQUIPMENT ALL OVER THE WORLD

External units that are part of HF-8 consist of the rectifier unit, the two high potential transformers that develop the voltage for the final R.F. and modulator stages and the modulation transformer and reactor. These are ordinarily located behind the transmitter proper, but can also be placed in an adjacent room several feet from the main unit, if necessary.

Examination of the HF-8 equipment will show that it has exceptional mechanical design. All frame members and chassis are constructed

of steel, copper plated where necessary to offer a low resistance ground path. The final finish is either a high quality enamel or plating as necessitated by the functions involved.

MODULATOR UNIT

This section of the HF-8 transmitter contains the complete audio circuit with exception of the modulation transformer and reactor.

The first two stages and associated components are located on the top shelf succeeded by the

The power amplifier tank circuit and coupling section are arranged for short lead lengths and fast frequency changing.

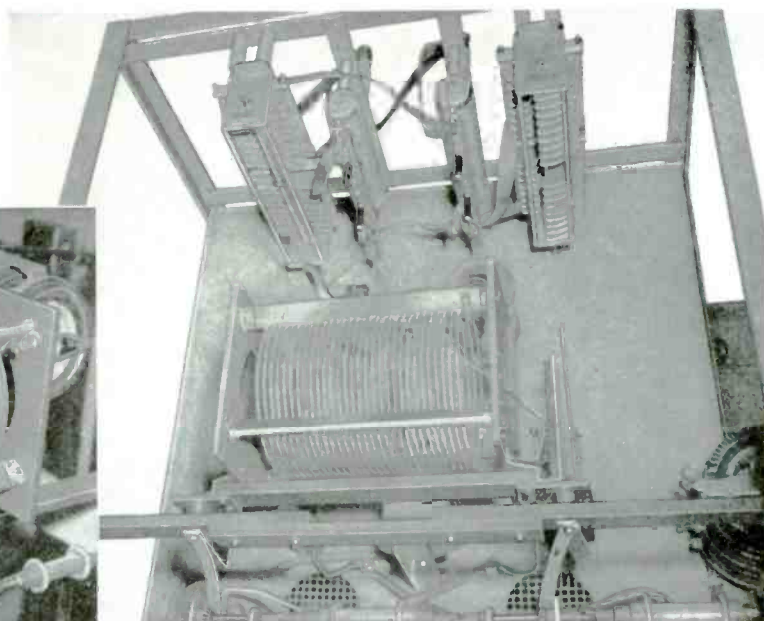
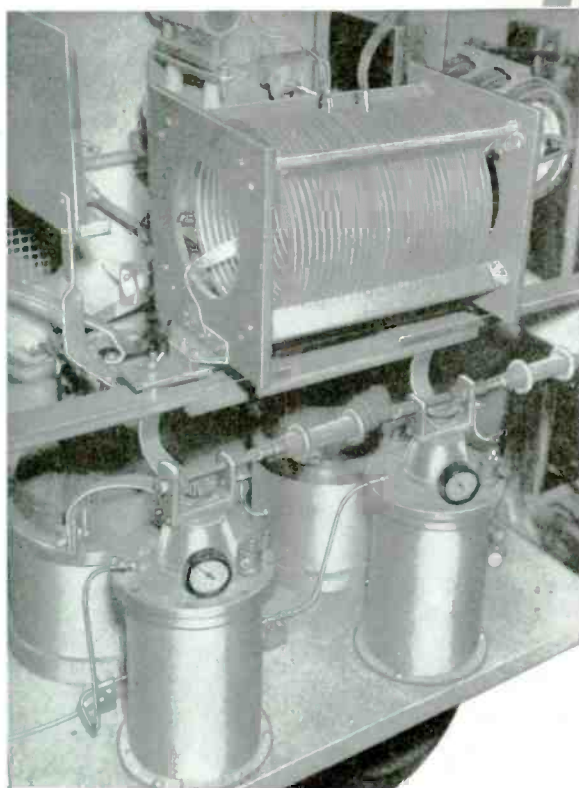

The nitrogen filled tuning capacitors for the final amplifier provide more compact construction than is usually found in apparatus of this type. Due to the fact that they are completely sealed, no insects, dust or other foreign material can enter.

GATES RADIO COMPANY
MANUFACTURERS, ENGINEERS, SINCE 1922
QUINCY, ILLINOIS, U.S.A.

GATES

TRANSMITTING EQUIPMENT

Proper ventilation, sturdy construction and accessibility are evidenced in the rectifier unit. The tubes, on the top shelf, are forced air cooled by an air tube with jets pointed at the base of each one. Air is supplied by a blower on the next shelf down.

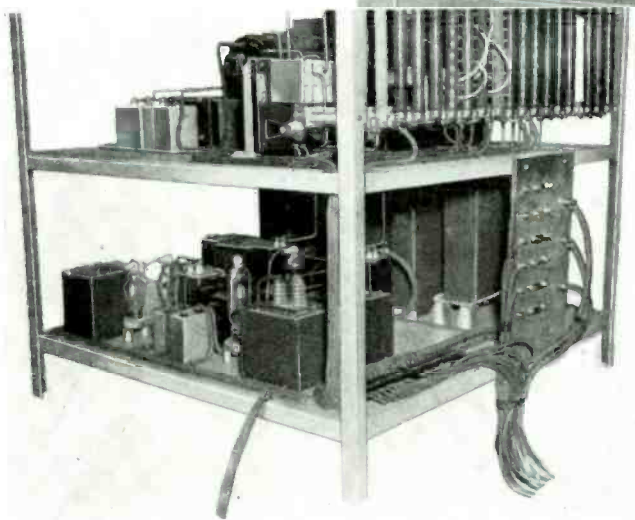
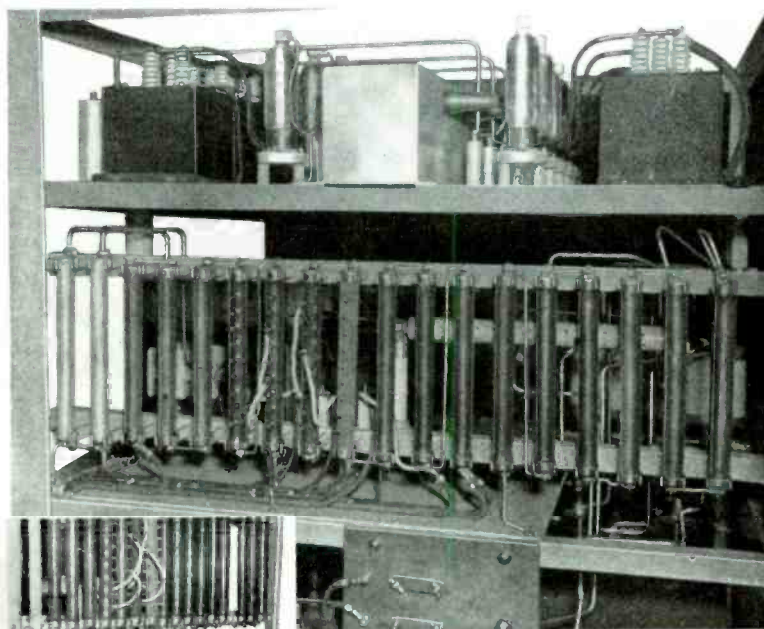

On the bottom shelf of the rectifier are found the high voltage filter capacitors and the low voltage rectifier.

third audio stage on the shelf below. The large steel panel to which these shelves are fastened also holds the filament transformers, modulator tube sockets and the feedback ladders.

Thru the selection of high quality components and the application of circuits of proven merit, excellent fidelity, low noise level and distortion are achieved.

RADIO FREQUENCY SECTION

Three amplifying stages in addition to the crystal oscillator are used in the Radio Frequency Section. Multi-channel operation, secured by means of rotary switches and tapped inductors in the low power stages and plug-in inductors in the high powered stages, is available throughout the entire frequency range.

GATES RADIO COMPANY
 MANUFACTURERS, ENGINEERS, SINCE 1922
 QUINCY, ILLINOIS, U.S.A.

GATES
TRANSMITTING EQUIPMENT
ALL OVER THE WORLD

FRONT PANEL CONTROL

Experience in the operation of transmitting equipment dictates that certain controls should be readily available for routine adjustment.

The effective placement of such facilities in the center of the front panel of the HF-8 transmitter is of particular advantage in that they are logically grouped and easily identifiable by the stenciled designations adjacent to each one.

The operative functions that can be accomplished are switching of the various filament circuits and power line phases to their re-

spective indicating meters, adjustments of filament voltages, varying the power output of the final R.F. stage and tuning of the plate circuits of the driver and final stages. Push button switches are used for turning on the filaments and high voltage plate circuits. A rotating "on-off" switch for the high voltage supply and a selector switch for the test meter are also supplied. Pilot lights behind colored jewels indicate when the transmitter is on the air, when the door interlocks are all closed and that the power supplies are functioning.



All functions are clearly indicated on the control panel section of the HF-8 transmitter.

GATES RADIO COMPANY
MANUFACTURERS, ENGINEERS, SINCE 1922
QUINCY, ILLINOIS, U.S.A.



TRANSMITTING EQUIPMENT

SPECIFICATIONS

- MODES OF OPERATION:** High Fidelity Radiotelephone or Radiotelegraph.
- CARRIER POWER OUTPUT:** 8 KW.
- CARRIER FREQUENCY RANGE:** 2 to 20 mcs.
- CARRIER FREQUENCY STABILITY:** Determined by frequency control equipment chosen. When using MO-2606 unit stability is .02%. When using MO-2606-A unit stability is .005%.
- MODULATION CAPABILITY:** 100%.
- AUDIO FREQUENCY RESPONSE:** + or - 2db, 30 to 10,000 cycles.
- NOISE LEVEL:** Approximately 50 db below 100% modulation.
- DISTORTION:** 5% at 90% modulation from 50 to 7500 cycles.
- KEYING SPEED:** 300 words per minute.
- OUTPUT IMPEDANCE:** 400 to 800 ohms, balanced to ground.
- AUDIO INPUT LEVEL:** + 6 vu from 500 ohm line for 100% modulation.
- TUBE COMPLEMENT** One type 807 oscillator, one type 807 first R.F. Amplifier, four type 813 second R. F. Amplifier, two type 889R final R.F. Power Amplifier, two type 6C6 first Audio Amplifier, two type 807 second Audio Amplifier, four type 845 third Audio Amplifier, two type 891R Modulator, two 872A keying bias rectifier, two type 807 keyer, six type 872A Main rectifier, three type 872A Auxiliary rectifier, two type 866A bias rectifier.
- METERING:** Meters are supplied for measuring power line voltage; filament voltage; Final R.F. Amplifier Grid Current; Plate voltage, Final R.F. Amplifier plate current, Right; Final R. F. Amplifier Plate Current, Left; Modulator plate current, Right; Modulator Plate Current, Left; Test Meter, (This meter is connected to a rotary switch which connects it into several major circuits of the transmitter); Second R.F. Amplifier grid current; and Second R. F. Amplifier plate current. (This latter meter has switching facilities for indication of plate current in either pair of driver tubes or the total current to the stage thus providing for precision balancing).
- POWER CONSUMPTION:** Radiotelephone operation, approximately 26 KVA standby, 30 KVA during average modulation, 40 KVA on modulation peaks. Radiotelegraph operation, approximately 8.5 KVA standby, 24 KVA key down.
- SPACE REQUIREMENTS:** Front Enclosure is 11 feet long and 7 feet high. Main transmitter unit extends behind front enclosure approximately 4 feet. Rectifier unit, Main and Auxiliary power transformers, and the modulation transformer and reactor sit external to the transmitter and require about 115 square feet of floor space. Total floor space requirements approximately 190 square feet. Packed for shipment, approximately 1400 cubic feet.
- WEIGHT:** Gross, 22,700 pounds; Net, approximately 10,000 pounds.
- HF-8 Transmitter less tubes and crystals for operation on 60 cycle, 220 volt, 5 phase power. Code YUSOV.**
- HF-8 Transmitter same as above but for 50 cycle operation. Code YUSUK.**

SALES OFFICES

123 Hampshire
Quincy, Illinois

40 Exchange Place
New York 5, N. Y.

Distributors are conveniently located
in other sections of the United States



GATES RADIO COMPANY
MANUFACTURERS, ENGINEERS, SINCE 1922
QUINCY, ILLINOIS, U.S.A.

Automatic Frequency Control Equipment

Model 25-A

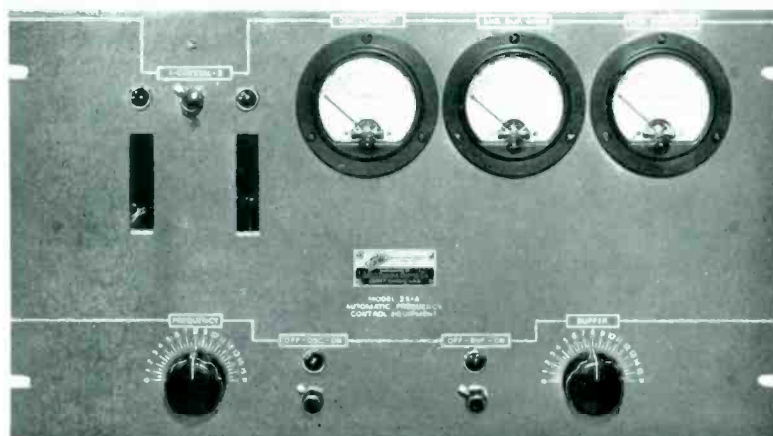

- 3 cycle or better accuracy
- For standard or medium high frequency broadcast service
- Dual temperature control ovens
- Self contained with 2 intermediate amplifiers and power supply
- Fully F.C.C. approved

GATES

TRANSMITTING EQUIPMENT

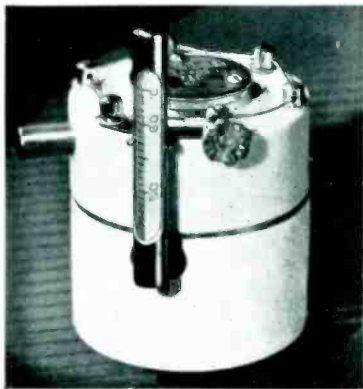

Oven Chamber

ovens which are Model BC46T units operate at 10 volts 1 ampere A.C. Crystal holders are of the variable air gap type and crystal current is held very low by the unique circuit employed assuring freedom from danger of arcing and resultant quick changes. Tuning consists of oscillator grid circuit providing about a 100 cycle oscillator tuning element and second I.P.A. plate tank. Switches are provided for final stage. All switches are adjoined by pilot lights. Though standard output as supplied is 73 ohms, capacity output may be had if desired. Provision is also made for ample excitation to any standard frequency monitor.

The 25A Automatic frequency control equipment employs no neutralizing circuits and after installation adjustment needs only routine attention such as tube checking and cleaning. All parts are quickly accessible if servicing is required and the popular vertical chassis design is employed in the construction. Standard equipment is finished in gloss gray but other finishes may be had. If other finishes are desired a sample color card is helpful when ordering.

TECHNICAL SPECIFICATIONS

FREQUENCY (carrier)—As ordered from 525 to 9000 Kc.
OVEN TEMPERATURE—Minimum 50 and maximum 58 degrees centigrade.
FREQUENCY TOLERANCE—Guaranteed plus or minus 10 cycles.
CARRIER SHIFT—As relating to the oscillator less than one percent.
F.C.C. APPROVAL NUMBER—Gates Radio Company Model 25-A.
TUBES USED—Two 802, one 45 and one 5Z3.
OUTPUT IMPEDANCE—73 ohms.

OUTPUT TO FREQUENCY MONITOR—Capacity coupled to ground.
INPUT VOLTAGE—115 volts (other voltages on special order.)
LINE FREQUENCY—50-60 cycles (other power line frequencies on special order.)
POWER CONSUMPTION—110 watts.
OPERATING CYCLE—Continuous.
NUMBER OF OVENS SUPPLIED—Two.
NUMBER OF CRYSTALS SUPPLIED—Two.
SIZE—19" wide, 10½" high, 14½" deep.

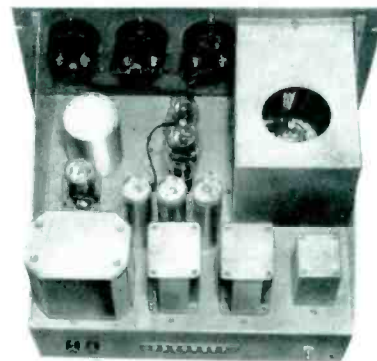

Rear Model 25A

GATES RADIO COMPANY
 MANUFACTURERS, ENGINEERS, SINCE 1922
 QUINCY, ILLINOIS, U.S.A.

GATES
TRANSMITTING EQUIPMENT
ALL OVER THE WORLD

Model DM-1
EQUIPMENT CABINET



The DM-1 cabinet is designed to accommodate apparatus requiring standard 19 inch rack mounting. Exterior finish and styling will harmonize with any equipment and particular attention has been given to matching with Gates transmitters to provide an attractive overall appearance in a complete installation.

GATES RADIO COMPANY
MANUFACTURERS, ENGINEERS, SINCE 1922
QUINCY, ILLINOIS, U.S.A.

GATES TRANSMITTING EQUIPMENT ALL OVER THE WORLD

Cold rolled furniture steel, securely welded and finished in two-tone grey enamel, is used throughout in the construction of the DM-1 cabinet. Seventy-one and three-quarter inches of mounting space is provided (41 panel units) with the vertical members drilled for standard RMA relay mounting. An access door in the back opens the full width and height making inspection of apparatus a simple matter. Wiring entrance is available through a rectangular cutout three inches wide and twelve inches long in the bottom of the cabinet.

An attractive feature of the DM-1 cabinet is obtained by using rounded styling strips on each of the front corners. These cover up all

mounting hardware and at the same time recess the panels a few inches which further adds to the appearance. Another new feature is the lumiline lamp which may be installed as accessory equipment. An aperture is provided in the top of the cabinet so that indirect lighting is obtained on the front panels. Not only is the effect pleasing but other lighting may be reduced to a minimum to permit better visibility from the control room into the studios.

Multiple cabinet installations are easily arranged. A connecting strip designed to join DM-1 cabinets when two or more are placed side by side in a room is available, this giving the appearance of a large single enclosure.

SPECIFICATIONS

Pertinent dimensions of the DM-1 Cabinet are given in the drawing below.
The shipping weight is 300 pounds for a single cabinet.

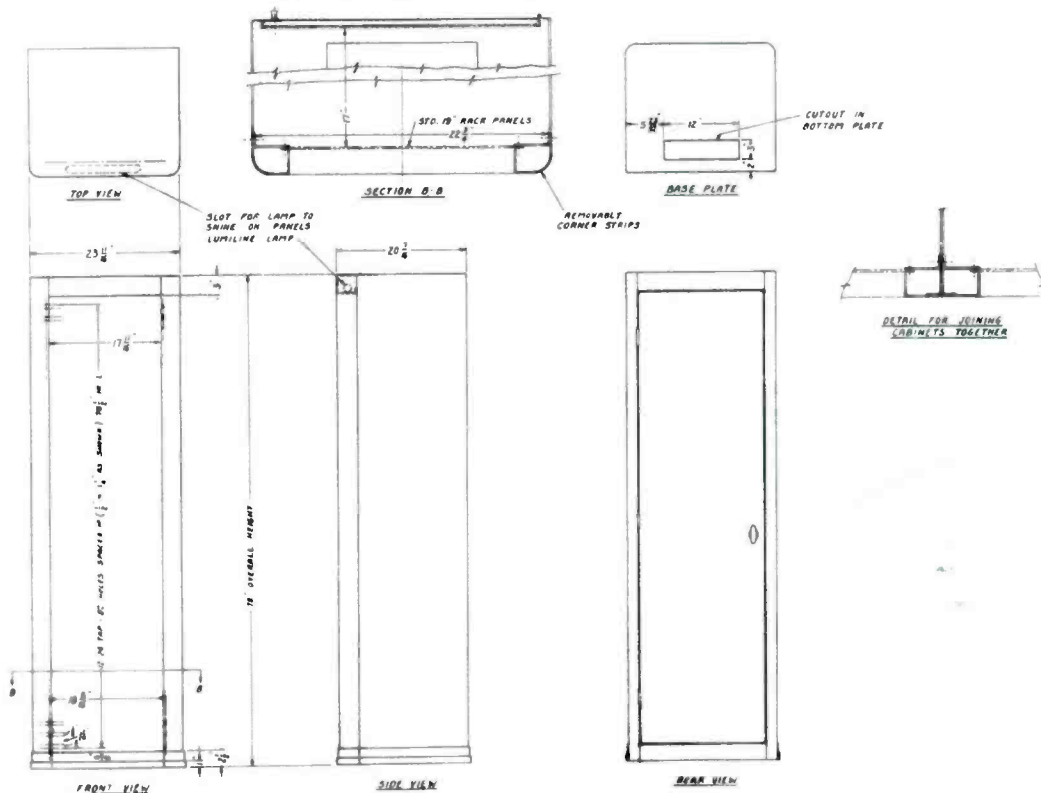

DM-1 Cabinet. Code ZACTY.
DM-1 Cabinet with Lumiline Lamp. Code ZACUS.
Connecting Strip for Joining DM-1 Cabinets. Code ZACYT.

GATES RADIO COMPANY
 MANUFACTURERS, ENGINEERS, SINCE 1922
 QUINCY, ILLINOIS, U.S.A.

GATES
TRANSMITTING EQUIPMENT
ALL OVER THE WORLD

ANTENNA TUNING AND LIGHTING EQUIPMENT

MODEL 46A



The units described herein are intended for use with vertical radiators of the type commonly used in standard broadcasting installations and will meet all such requirements. Instances arise where special equipment is

needed. In these cases our engineering department should be contacted and at the same time sufficient information given to determine customer requirements. Prompt action will be given all inquiries of this nature.

GATES RADIO COMPANY
MANUFACTURERS, ENGINEERS, SINCE 1922
QUINCY, ILLINOIS, U.S.A.

www.americanradiohistory.com

GATES
TRANSMITTING EQUIPMENT
ALL OVER THE WORLD

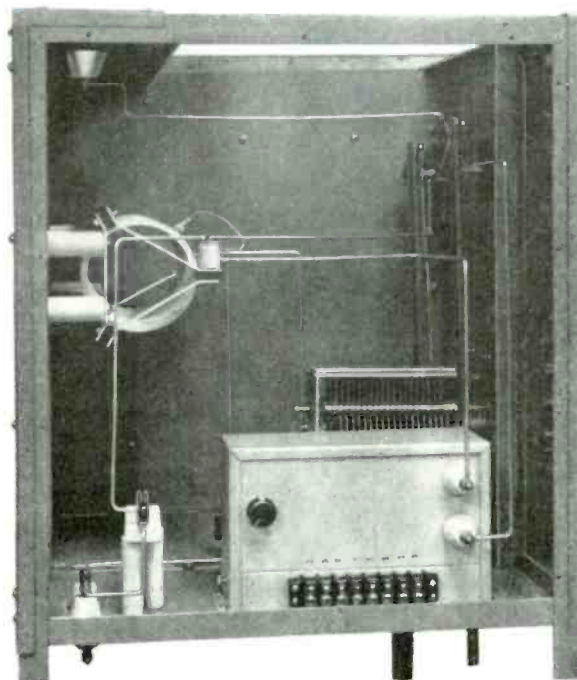

Internal view of the 46A equipment showing the antenna tuning components and the MO2765A remote diode rectifier.

Now it is possible to obtain your complete tuning and lighting equipment in one unit housed in a cabinet suitable for installation in any convenient weatherproof shelter. In addition, the MO-2765A diode rectifier remote metering equipment is included. Power handling ability of this equipment is 1 KW, modulated.

The antenna tuning portion of the 46-A equipment consists of the variable and fixed capacitors and inductance to match practically any vertical antenna to a transmission line of fifty

to three hundred ohms. Any portion of the inductance may be quickly selected by means of shorting straps and high current capacity clips. The proper arrangement of capacitors can be quickly made by connecting links to suit requirements. Four inch meters equipped with shorting switches are included to indicate line and antenna current.

The tower choke equipment consists of three 4" bakelite tube 15" long wound full of No. 12 D.D.C. wire and two high impedance concentric honeycomb sections on the tower side of each

GATES RADIO COMPANY
MANUFACTURERS, ENGINEERS, SINCE 1922
QUINCY, ILLINOIS, U.S.A.

GATES
TRANSMITTING EQUIPMENT
ALL OVER THE WORLD

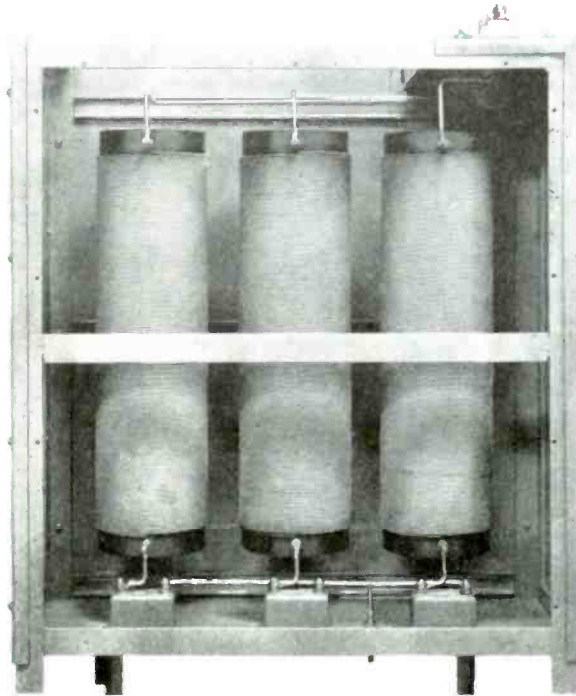

This portion of the 46A equipment contains the tower lighting chokes.

coil, with the power line ends heavily shielded from the radio frequency coupling equipment to avoid possibility of interaction.

The remote meter equipment is the popular Gates MO-2765A diode type remote meter kit mounted as part of the 46-A equipment. This type of remote meter offers greater security from lightning damage than any other type as the remote meter function is inductively coupled and no thermocouples are employed. Supplied with the 46-A equipment is a remote meter for use with any make of transmitter which may be either three or four inches in

size and with scale to meet customer requirements. If desired a relay rack panel is available for mounting this meter where room is not available for mounting on the transmitter.

Openings are provided for conduit or lead covered cable entrance for lighting and remote meter lines. Connections for the tower leads both for RF and lighting are brought through on ceramic insulators. The cabinet is sturdily made of steel plate and is reinforced by steel angle. Legs are provided to bring the unit up to a convenient height. Finish is grey enamel baked on to insure long wear.

GATES RADIO COMPANY
MANUFACTURERS, ENGINEERS, SINCE 1922
QUINCY, ILLINOIS, U.S.A.



TRANSMITTING EQUIPMENT

TECHNICAL SPECIFICATIONS

46A Equipment

SIZE: 44 inches high, 28 inches wide, 20 inches deep.

POWER RATING: For 1 KW, 500 watt, and 250 watt installations.

R.F. INPUT IMPEDANCE: For 50 to 300 ohm line.

R.F. OUTPUT IMPEDANCE: For nearly all standard vertical radiators 20 to 300 ohms resistance.

METERING: 4" type line meter (scale 0-5) 50 scale divisions.

4" type antenna meter (scale as required) 30-60 scale divisions.

TOWER CHOKE RATING: Designed for 1000 watt flashing type beacon and two section stationary lights. Flasher not supplied.

REMOTE METER UNIT: Gates MO-2765A (see separate catalog bulletin).

INFORMATION NEEDED WHEN ORDERING

When ordering, as much information as possible is desired and is given below in question form. If all answers are not known, give as much information as possible.

- 1—Frequency of operation.
- 2—Tower height.
- 3—Type of transmission line.
- 4—Length of transmission line.
- 5—Antenna resistance.
- 6—Will remote meter be mounted in transmitter or is rack panel desired.

Gates Model 46-A Tower Tuning and Lighting Equipment. Code—ZABAM.



GATES RADIO COMPANY
MANUFACTURERS, ENGINEERS, SINCE 1922
QUINCY, ILLINOIS, U.S.A.

ANTENNA TUNING UNITS

Models 21-A and 21-B

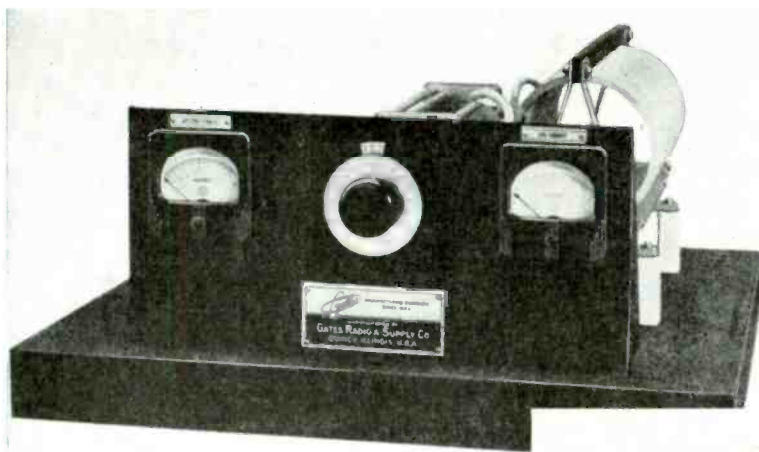

This view of the 21 Series Antenna tuning units shows the front with the cover removed.

This rear view illustrates the generously proportioned components and construction of the 21 Series.

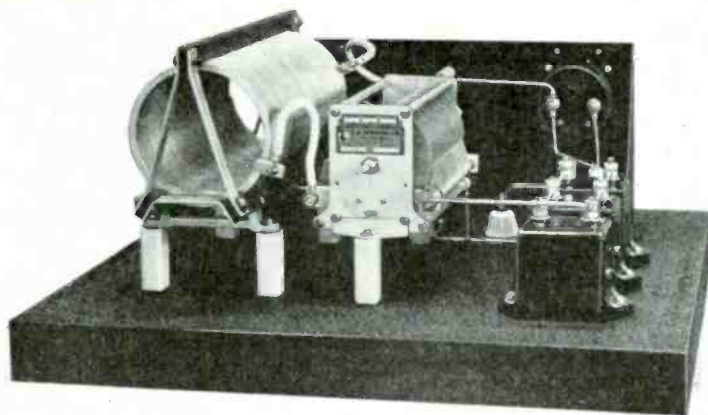

GATES
TRANSMITTING EQUIPMENT
ALL OVER THE WORLD

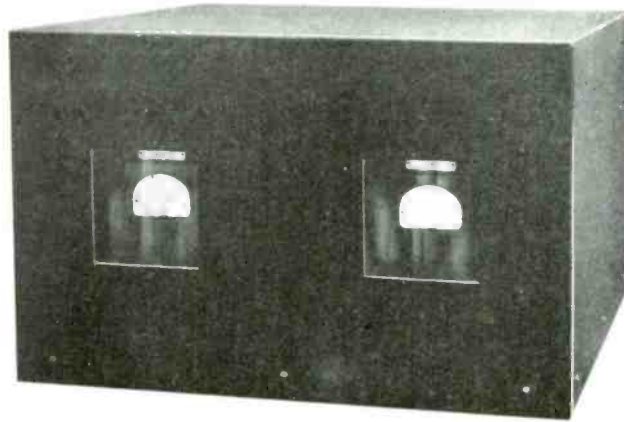

Front view of the 21 Series antenna tuning equipment with the cover in place.

These two antenna tuners are conventional in design and provide all the necessary components for matching most vertical broadcast towers to transmission lines having a surge impedance from fifty to three hundred ohms. Instructions are provided with each one to facilitate proper connection to obtain exact electrical match and optimum efficiency.

The 21-A and 21-B are identical except for rating; the 21-A being for two hundred and fifty watts power or less and the 21-B for maximum power of one thousand watts.

A variable tuning capacitor supplemented by fixed capacitors associated with an inductance whose value may be varied by the shorting straps provided constitute the operating elements. Two RF ammeters, one for indicating line current and the other for showing

antenna current are also provided. Provision is made for mounting an RF thermocouple to provide the energy to operate a remote RF meter. The general design produces the configuration of a low pass filter providing high harmonic suppression when correctly tuned and used with a properly designed transmission line. A static drain is provided.

Sturdy weatherproof construction is accomplished by covering the chassis with a seam welded housing which is fastened in place by screws around the lower edge. A pipe flange is provided on the bottom for mounting purposes. All parts are finished in grey baked outside industrial enamel to withstand severe weather conditions. Openings for RF transmission and remote meter lines are in the bottom and windows for viewing the meters are on the front of the housing.

GATES RADIO COMPANY
MANUFACTURERS, ENGINEERS, SINCE 1922
QUINCY, ILLINOIS, U.S.A.



TRANSMITTING EQUIPMENT

SPECIFICATIONS

SIZE: 11 inches high, 16 inches deep, 20 inches wide.

POWER RATING: Model 21-A, 250 watts.
Model 21-B, 1000 watts.

R.F. OUTPUT IMPEDANCE: Will match radiators having resistance of 20 to 175 ohms and reactance of 500 ohms maximum, either capacitative or inductive.

METERS: 3½" type, scale divisions exceed FCC requirements.

INFORMATION FOR ORDERING

When ordering please give as much information as possible. Answers to the questions below will enable us to ship a properly designed unit for your use.

- 1—Frequency of operation.
- 2—Tower height.
- 3—Type of transmission line.
- 4—Length of transmission line.
- 5—Antenna resistance.
- 6—Will remote meter be mounted in transmitter or is rack panel mounting desired.

21-A Antenna Tuning Unit, 250 watts power rating. Code—YUHUX.

21-B Antenna Tuning Unit, 1000 watts power rating. Code—YUHW0.



GATES RADIO COMPANY
MANUFACTURERS, ENGINEERS, SINCE 1922
QUINCY, ILLINOIS, U.S.A.

TRANSMITTING EQUIPMENT

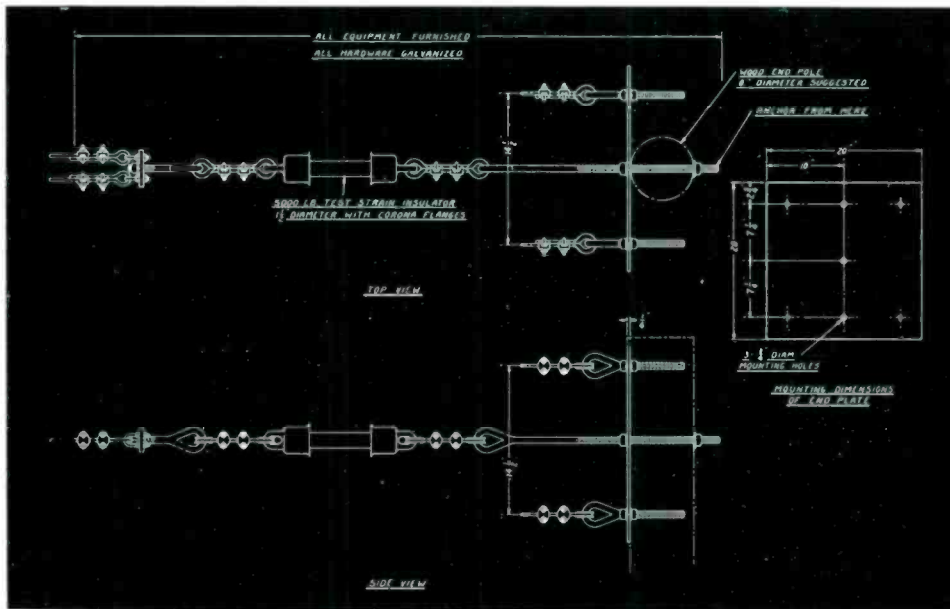

End plate assembly MO-2857 contains all the hardware necessary for terminating the ends of a five or six wire transmission line including a 5000 lb. test strain insulator and turnbuckles for tightening all wires. All metal items are

galvanized or plated so that exposure to the elements will not cause rust or oxidation. Dimensions and complete assembly are shown in the above drawing.

MO-2857 End Plate Assembly. Code ZAGRA.

MO-2870A and B Feedthru bowls are identical except for the length of the center stud. MO-2870A has a stud $11\frac{1}{2}$ inches long and MO-2870B's stud is $15\frac{1}{2}$ inches long suitable for use in partitions or walls 2 inches and 6 inches thick respectively. The insulator bowls are made of glazed ultra steatite and as the hardware is all plated use in places exposed to the weather is entirely suitable.

At the right is an illustration showing a suggested method of installation. All hardware is supplied except the terminal lugs.

MO-2870A Feedthru Bowl. Code ZAGSE.
 MO-2870B Feedthru Bowl. Code ZAGVO.

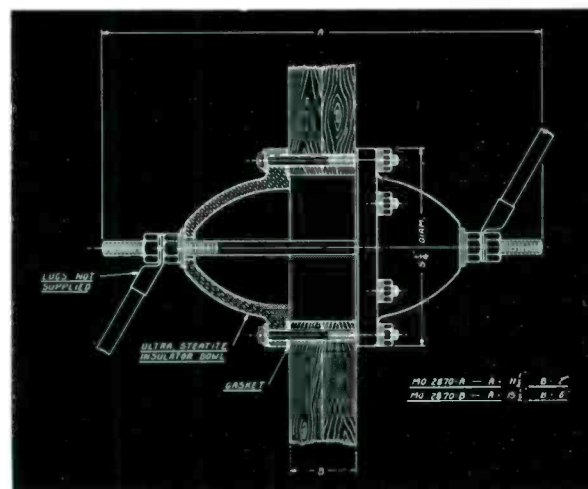

GATES RADIO COMPANY
 MANUFACTURERS, ENGINEERS, SINCE 1922
 QUINCY, ILLINOIS, U.S.A.

MODEL MO-2639 MODULATION MONITOR

For Amplitude Modulation

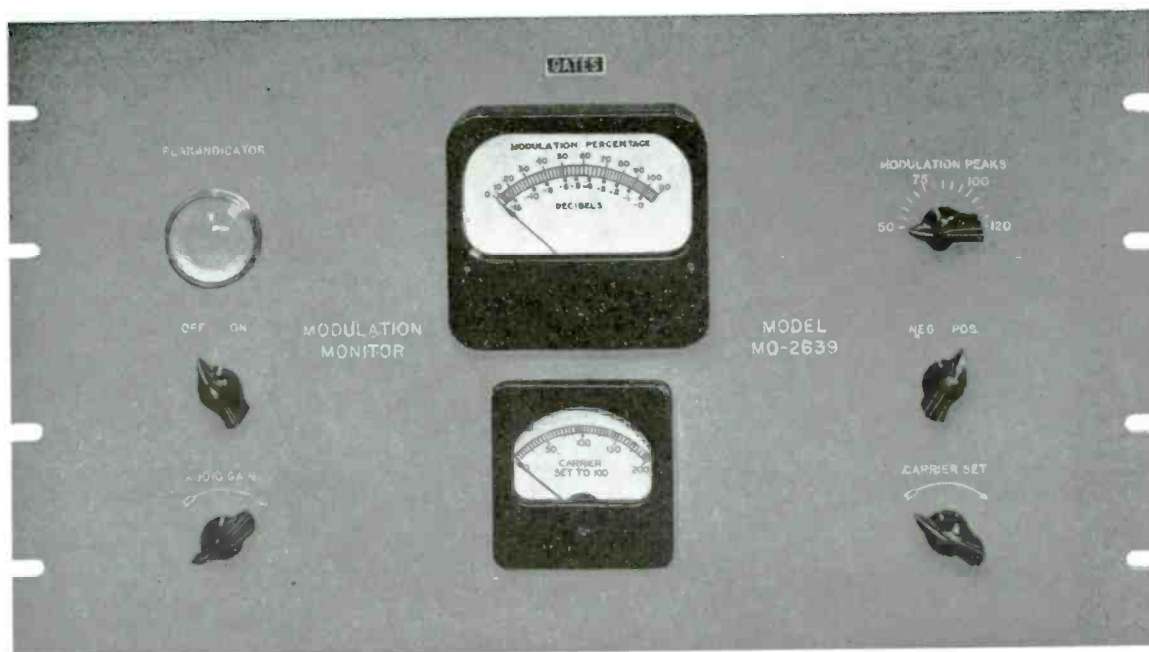

This front view of the MO-2639 Modulation Monitor shows the neat panel arrangement of the meters and controls. It is completely approved by the Federal Communications Commission and bears approval number 1556.

The MO-2639 monitor is designed to indicate the percentage of modulation that occurs in amplitude modulated transmitters. It incorporates all the usual functions of an instrument of this kind plus the added feature of "off the air" audio monitoring. This is accomplished by the inclusion of an audio amplifier having ample power to drive any ordinary loud speaker. The necessity of installing a monitoring amplifier at the transmitter location is thereby eliminated.

Standard panel and chassis construction is used in this instrument. Controls available on the front panel provide for carrier set, switching from negative to positive modulation readings,

adjusting the peak indicator over the range of 50 to 120%, control of audio amplifier output and turning the power off and on.

The meter which indicates modulation percentage is calibrated from -15 db. to 0 db. as well as from 0 to 110%. A neon bulb is mounted behind a frosted glass "bull's eye" on the front panel and operates when the modulation percentage exceeds the percentage indicated by the modulation peak setting control. A ceramic insulated terminal post on the rear of the chassis accommodates the radio frequency input connection. All other terminations are made on a barrier type phenolic terminal strip also located on the back of the chassis.

GATES
TRANSMITTING EQUIPMENT
ALL OVER THE WORLD

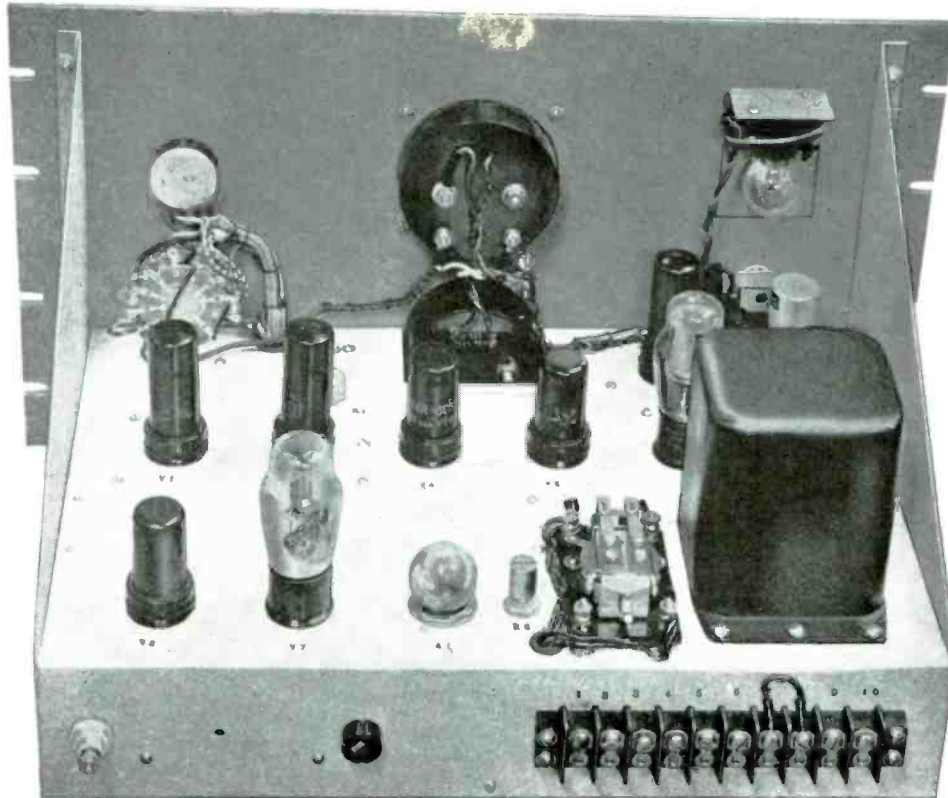

Rear View of the MO-2639 Modulation Monitor

Each of these instruments is carefully manufactured in accordance with the specifications set forth by the Federal Communications Commission in the Standards Of Good Engineering

Practice and has been approved by the FCC for use as a modulation percentage monitor in standard broadcast stations. The approval number is 1556.

SPECIFICATIONS

FREQUENCY RANGE—100-5000 kilocycles.
INPUT—High Impedance requiring about ½ watt excitation.
LOUD SPEAKER IMPEDANCE—4 to 8 ohms.
TUBES—Three 6X5, three 6C5, one each 6F6, 885 and VR150, plus one neon flasher light and two 6 volt meter lights.
MODULATION PERCENTAGE RANGE—0-110%.
CARRIER LEVEL METER RANGE—0-200%.
DECIBEL SCALE RANGE—Calibrated to 15 Db. below 100% modulation.
AUDIO AMPLIFIER—Range exceeds best quality speaker capabilities.
POWER CONSUMPTION—65 Va. at 115 volts 50/60 cycles.
FCC APPROVAL NUMBER—1556.
WEIGHT—Net, 27 lbs. Gross, 40 lbs.
DIMENSIONS—10½ inches high, 19 inches wide, 13½ inches deep.
 Packed for shipment, 3.7 cu. ft.

Model MO-2639 Modulation Monitor complete with tubes. Code ZAEMZ.
 External Modulation Percentage Meter only for Remote Indicating. Code ZAERF.

GATES RADIO COMPANY
 MANUFACTURERS, ENGINEERS, SINCE 1922
 QUINCY, ILLINOIS, U.S.A.

GATES
TRANSMITTING EQUIPMENT
ALL OVER THE WORLD

Model 31B DeLuxe Speech Input Control Console

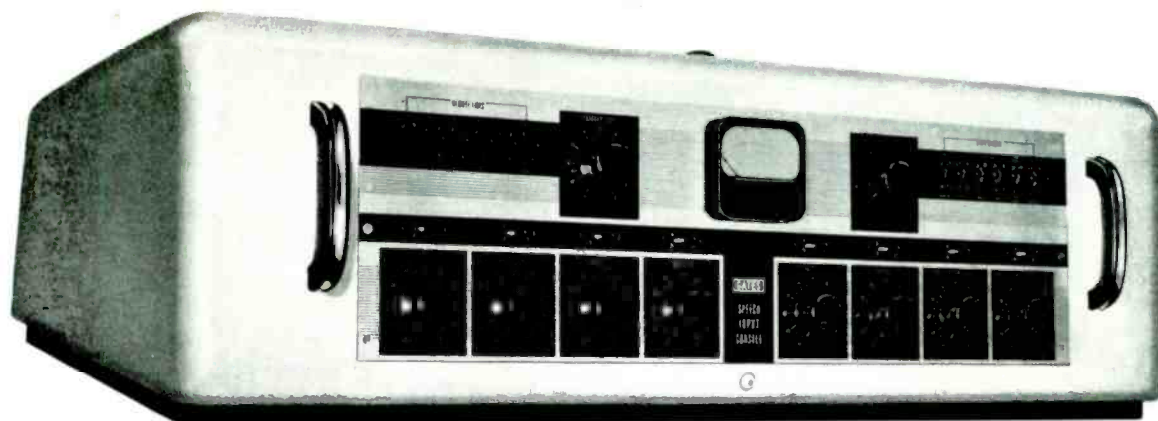

Designed for AM or FM this fine Gates product will be found in radio stations around the world. It affords stellar performance combined with a wide variety of facilities, fine construction and superior eye value plus a new design tilt back cabinet making servicing as easy as opening a door. Full technical detail will be found on the following pages.

GATES RADIO COMPANY
MANUFACTURERS, ENGINEERS, SINCE 1922
QUINCY, ILLINOIS, U.S.A.

www.americanradiohistory.com

TRANSMITTING EQUIPMENT

The 31B Console from the Manager's eye

Is an instrument that he will like to locate conspicuously so that both his customers and visiting listeners will receive a lasting impression of the well equipped broadcasting station. It is finished in medium gray with base trim in black and handles in plastic with chrome trim. It is certainly radio broadcasting at its finest. The center control panel is of anodized aluminum with lettering in natural color against an etched black back ground, well streamlined to be attractive enough to the operator to give him a feeling of confidence in the operation of good apparatus.

The station manager is also attracted to the ease of servicing where the entire cabinet tips back and reveals every under part and soldered connection. Repairs, if necessary, can be made in minutes instead of hours and valuable "on the air" time is saved. Though Gates equipment is designed to prevent failures, there are certain maintenance requirements such as cleaning of controls that must often be done quickly and without loss of air time. In the 31B Console both bottom and top parts can be instantly reached.

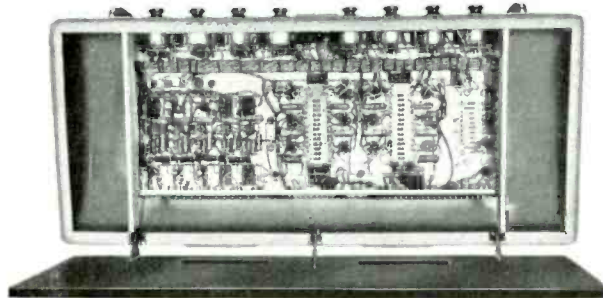

Gates design tilt back cabinet with extra solid base assures complete servicing of every component.

The 31B from an Engineer's eye

Is a galaxy of high quality components assembled into a neatly wired rugged instrument that will give thousands of pleasurable trouble free hours of high fidelity broadcasting to meet either AM or FM demands. Minor things have not been overlooked. For example, the entire cable that connects the various mixers, pre-amplifier, remote and turntable lines is tied to a heavy metal cross bar so that the cable is not self supporting but rigidly held. This cable is also numbered so that servicing may be quickly and accurately done.

The 31B Console is a one piece chassis. Thus, it is one complete instrument and not a multitude of small assemblies that often times become a chinese puzzle to service and maintain. As a result, if you wish to trace from one circuit to another it is done all on one integral chassis, simply, quickly.

What does the 31B control console have?

To touch on all combinations of things that could be done would take pages. A block diagram is provided to give you this information in part. The 31B is complete and leaves little to be desired, even in comparison to many larger types of rack design speech equipment. The main features are as follows:

(a) **PRE-AMPLIFIERS**—There are five two-stage pre - amplifiers. Note that they are two-stage, which means lower over all noise, higher gain, wide flexibility of controls and consequently better broadcasting. These pre-amplifiers operate in conjunction with five mixer channels for microphones. Pre-amplifiers are not supplied for turntables as newer design transcription equipments have pre-amplifiers self contained but where pre-amplification is not available with your turntables the Gates 61-B pre-amplifier may be used mounted into each end of the cabinet. See space provided on under view illustration.

(b) **MIXER** — There are 8 channels in all. More could be provided if needed but control equipment should not be cramped. These 8 channels allow for five microphones, two turntables and a combination remote-network attenuator. Each mixing channel has above it a two way key (Stromberg telephone type) which allows operation of the mixer to either program or audition busses. Microphone keys also operate muting relays which are part equipment (see relays).

TRANSMITTING EQUIPMENT

(c) **RELAYS** — Three are supplied with contacts for loud speaker muting (make before break) and added contacts for signal warning light switch break. Relays operate from a six volt D.C. source provided from the console power supply. Relays are fully protected from dust by a cover provided, quickly removable for servicing.

(d) **REMOTE KEYS** — Six are provided so that any of six remote lines may either broadcast or receive cues, simultaneously or separately. Full repeater transformer complement isolates and keeps line in balance.

(e) **NET WORK KEY** — Provided to handle two net work lines such as major net and supplementary net. Net work key holds priority over remote keys and when operated disconnects remote circuits. Where net work is not used this key may be used for two additional remote lines.

(f) **OUTPUT KEY** — Allows connecting either the program or audition amplifier to the program line. In case of tube failure in the program amplifier the audition amplifier may be instantly connected to the circuit without loss of air time in any way.

(g) **TALK BACK KEYS** — Provided so that two microphone pre-amplifiers may by-pass all normal circuits for use in talk back, separate recording service, audition service above normal requirement and broadcasting to an independent circuit without disrupting the normal broadcasting equipment compliment.

(h) **PHONES KEY** — So provided that head phones may be used for either program or remote line listening.

(i) **AUDITION-MONITOR KEY** — Allows use of the audition amplifier for operation directly from the output of the program amplifier for program monitoring or from the audition mixer buss for auditioning, recording or advance program checking.

(j) **PROGRAM AMPLIFIER** — Is a full size three stage all push-pull amplifier using a pair of 6J7 first stage tubes, a pair of 6C5 second stage tubes and a pair of 6F6 third stage tubes.

Note that tubes used are easy to obtain. The use of push-pull assures low harmonic distortion and low noise.

(k) **AUDITION OR MONITORING AMPLIFIER** — Identical to the program amplifier in every respect.

(l) **POWER SUPPLY**—A heavily built, high quality unit providing all filament and plate voltages plus 6 volts direct current for relay operation. Power supply uses oil filled filter condensers and ultra conservative rating of parts throughout. If duplicate power supplies are desired a second supply may be had at a reasonable cost.

(m) **VOLUME INDICATING METER** — Full size four inch Weston 862 illuminated type. Range switch allows five positions of attenuation up to 20 VU.

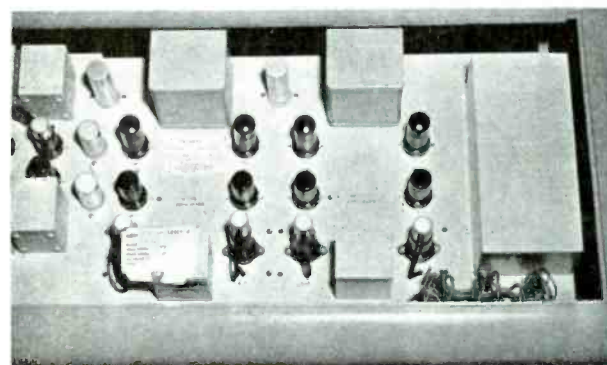
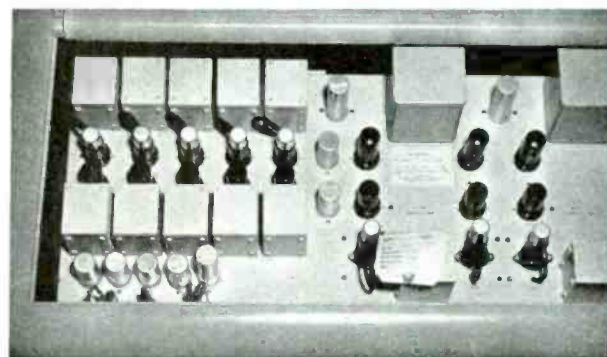

Upper illustration shows left section of main chassis looking from top illustrating the five pre-amplifiers and line amplifier. Lower illustration shows right section with monitor amplifier and muting relays under dust cover.

GATES TRANSMITTING EQUIPMENT ALL OVER THE WORLD

TECHNICAL DETAIL

TUBES USED—Five type 6F5, nine type 6C5, four type 6F6, one type 5Z3.
POWER DRAIN—Approximately 175 watts from a 115 volt 60 cycle line.
FREQUENCY RESPONSE—Flat from 30 to 15,000 cycles within plus or minus one decibel.
NOISE REDUCTION—60 Db. below program level or better.
DISTORTION—1% or less at all frequencies 50 to 15,000 cycles.
OVERALL GAIN—111 Db.
RATED OUTPUT LEVEL—Plus 24 VU or less as required.
OUTPUT WATTAGE FOR LOUD SPEAKERS—5 watts.
INPUT IMPEDANCE TO PRE-AMPLIFIERS—50, 250 or 500-600 ohm circuits.
INPUT IMPEDANCE TO TURNTABLES CHANNELS—250 ohms.
INPUT IMPEDANCE TO REMOTE AND NET LINES—600 ohms.
OUTPUT IMPEDANCE TO PROGRAM LINE—600 ohms.
OUTPUT IMPEDANCE TO MONITOR LINE—600 ohms.
SIZE—47 inches long, 15 inches high, 22 inches deep.
WEIGHT—370 lbs. packed for domestic shipment. Export, approximately 490 lbs.
COLOR—Two-tone gray with base trim in black.

Gates Model 31B Console complete with tubes and power supply. Code ZACPE.

Gates Model 31BPX Extra Power Supply only. Code ZADPA.

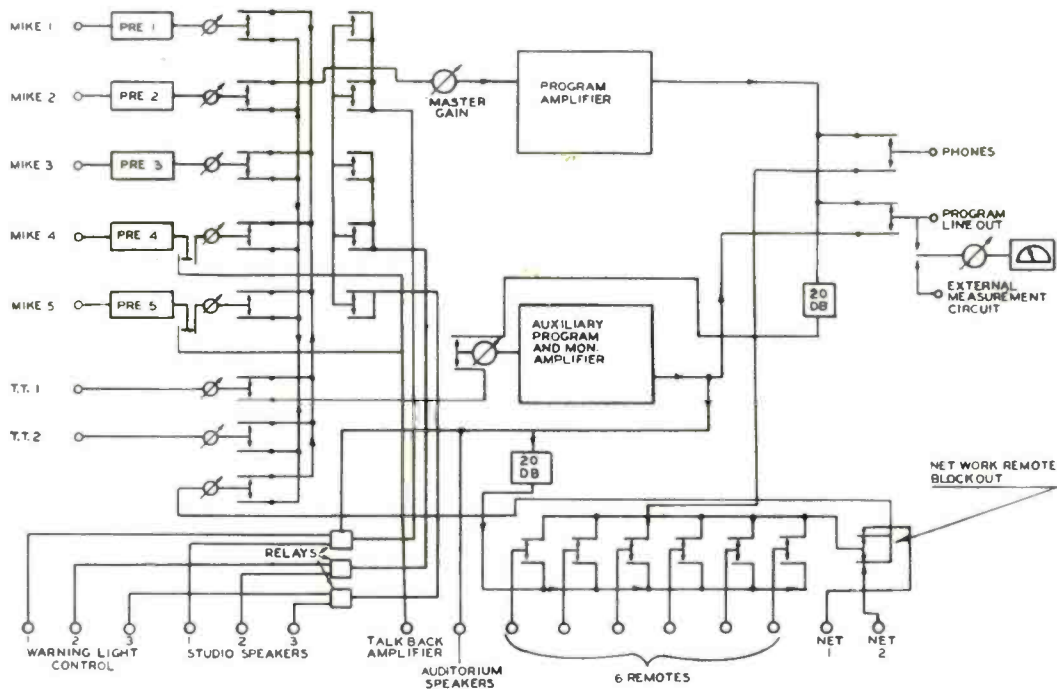

Block Diagram Model 30 Console

GATES RADIO COMPANY
 MANUFACTURERS, ENGINEERS, SINCE 1922
 QUINCY, ILLINOIS, U.S.A.

GATES
TRANSMITTING EQUIPMENT
ALL OVER THE WORLD

CB-4 STUDIO COMBINATION

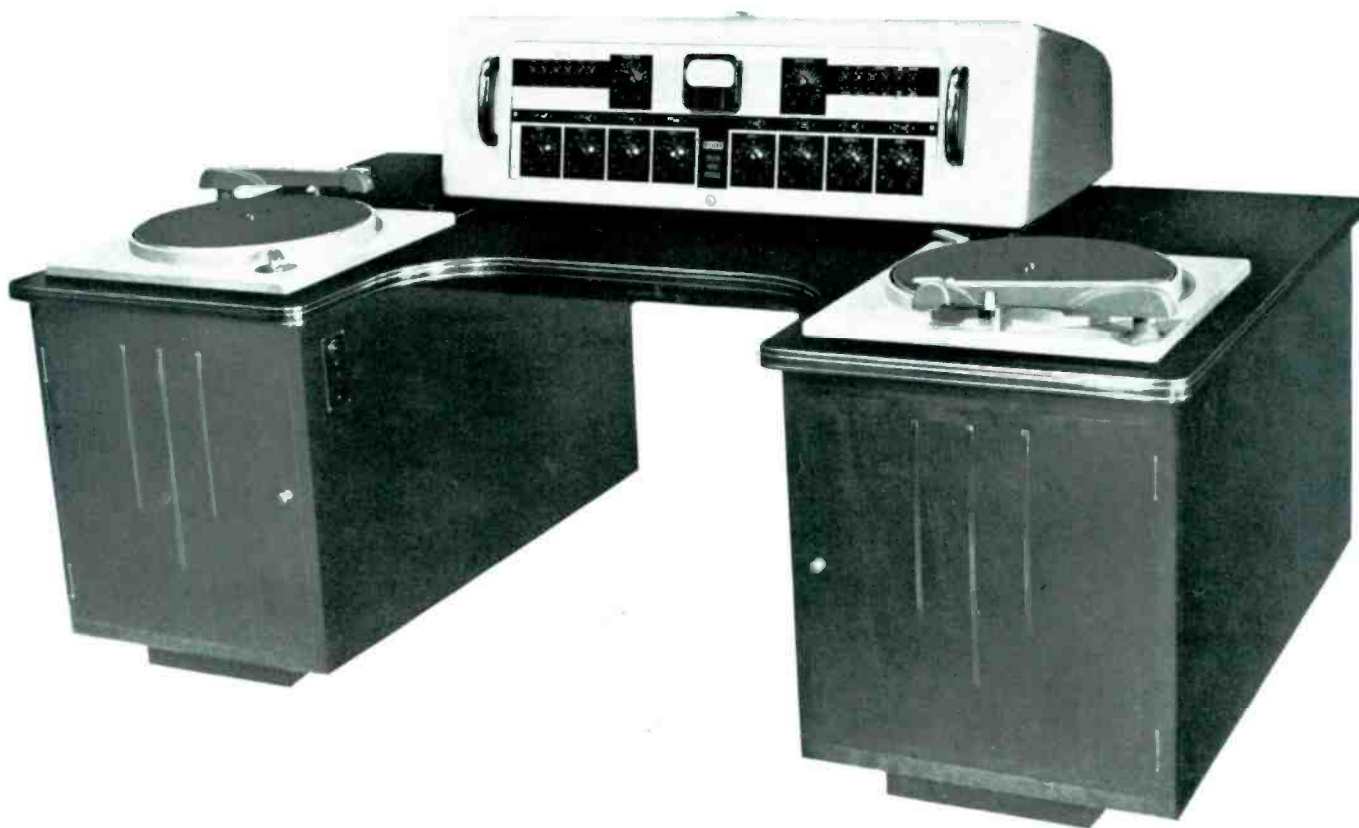

Extensive use of the CB-4 Combination has made its worth well known to hundreds of broadcasters, not only for small operations but large ones as well. The various equipment selections available offer complete flexibility, ease of operation and maintenance provisions that are hard to imitate and never equaled in similar equipment.

GATES RADIO COMPANY
MANUFACTURERS, ENGINEERS, SINCE 1922
QUINCY, ILLINOIS, U.S.A.

GATES
TRANSMITTING EQUIPMENT
ALL OVER THE WORLD

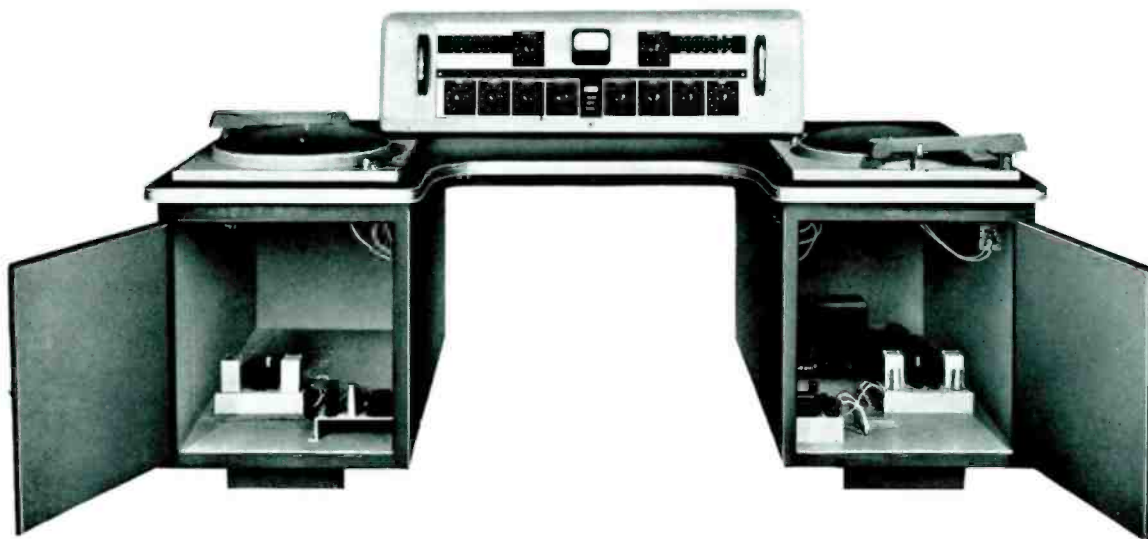

This open door view of the CB-4 Combination shows how the space is utilized for installing transcription channel preamplification equipment. The 31-B Console power supply is located in the right compartment. All wiring is shielded to prevent noise pickup. Switches are placed conveniently in the knee-hole area to control power application. They are of the noiseless mercury type.

THE CB-4 Combination consists of a console mounted on a superbly styled desk plus transcription reproducing equipment with built-in preamplification for each transcription channel. Various combinations of apparatus are available to suit particular requirements.

DESK

Good appearance is an important factor in any broadcasting studio because that portion of your station is often visited by the public. The desk supplied with the CB-4 Combination certainly satisfies the good appearance necessity and at the same time offers a substantial location for the speech or control console, transcription turn-tables and reproducers. Operators can handle the equipment smoothly as it is all located within easy reach at all times. The initial expense is low as the necessity for turn-table cabinets is eliminated plus the cost of any other table or desk, on

which the console could be mounted, that could not possibly duplicate the appearance or utility of the splendid desk supplied with the CB-4.

Selected woods are used throughout, veneered on plywood firmly assembled with ample bracing so that rigorous use may be expected for many years. The top is covered in battleship linoleum to withstand marring and stain. High quality varnish safeguards the appearance of all other surfaces. Wide doors expose the front of each side compartment and the back of each may be easily removed.

TRANSCRIPTION EQUIPMENT

Two type CB-11 transcription turn-tables are installed on the CB-4 with the speed control switches arranged for easiest manipulation by the operator. Reproducer equipment may be either standard lateral or universal. Either type has a diamond stylus and the heads are

GATES RADIO COMPANY
MANUFACTURERS, ENGINEERS, SINCE 1922
QUINCY, ILLINOIS, U.S.A.

GATES TRANSMITTING EQUIPMENT ALL OVER THE WORLD

quickly removable without unsoldering any connections or using special tools.

Preamplification is supplied for each channel. This portion of the equipment is mounted in the compartments on either side of the desk and is completely wired with special attention given to shielding and grounding to provide a high quality installation with a low noise level.

Mercury switches are located inside the knee-hole of the desk on either side but high enough to escape normal motion of the operator so that accidental application is prevented. These switches afford separate power application to each turn-table motor and master power control to the entire system including turn-table preamplifiers and the console.

CONSOLE

Standard equipment on the CB-4 Combination is the 31-B Console although other units can also be used such as the control portion of the 5M or special audio equipments, the Studioette or any specially designed equipment required for studio control.

The 31-B Console is a very popular two studio unit containing five microphone preamplifiers, a line amplifier, and an audition amplifier. Two controls are provided for transcription channels and one for remotes. Switches on the front panel provide for connecting any one of six remote lines to the remote channel, changing each microphone channel from "line" to "audition" and many other functions such as remote cueing, choice of two network lines, interchanging of line and program amplifiers and connection of the headphone monitoring circuit

to the program line or remote line. Controls for each microphone channel operate attenuators electrically placed in the output of the preamplifiers so that the advantages of high level mixing are obtained.

Overall fidelity, noise and distortion of the 31-B Console are entirely suitable for FM and the gain of approximately 105 decibels from microphone input to program amplifier output is adequate for use with any standard microphone.

The cabinet is made of high quality furniture steel styled in the modern manner and arranged for ease of maintenance and operation. The baked multi-coat enamel finish is in two-

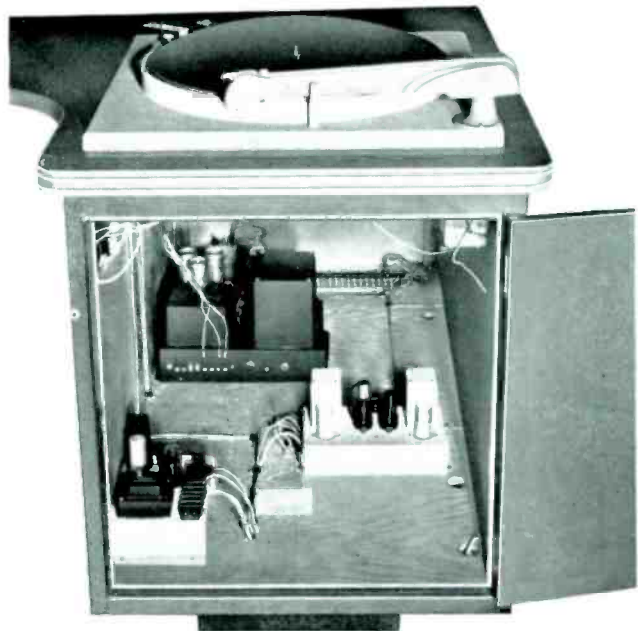

In each end of the CB-4 Combination is a spacious compartment as shown above. In it are installed the preamplifiers for the transcription channels, their power supplies and the power supply for the 31-B Console.

GATES RADIO COMPANY
MANUFACTURERS, ENGINEERS, SINCE 1922
QUINCY, ILLINOIS, U.S.A.



TRANSMITTING EQUIPMENT

tone gray that will harmonize with any decorative color scheme.

Full details of the 31-B Console are available elsewhere in the catalog.

ENGINEERING

Arrangements deviating from standard are sometimes necessary due to many program-

ming problems that require specialized handling. The engineering department of the Gates Radio Company is available at all times to discuss such matters and men are available that have had years of actual broadcasting experience thus placing practical experience along with advanced theory at your disposal. All you need to do is let us know your requirements and they will be handled promptly.

SPECIFICATIONS

SIZE: Desk only—48 inches deep, 84 inches wide, 30 inches high.
Desk only, crated—53x90x32½ inches.
Turntables, boxed—23½x25x9½ inches.
Console—14¼ inches high, 21 inches deep, 47 inches wide.
Console, boxed—58x29½x24½ inches.
Console Power Supply, boxed—23x13x12 inches.

WEIGHT: Desk only—550 lbs. packed.
Turntables only—90 lbs. each packed.
Console with Power Supply—370 lbs. packed.

POWER SOURCE—115 volts 50/60 cycles AC.

- CB-4 Studio Combination.** Complete with 31-B Console, two CB-11 Transcription turn-tables, two UL-2 vertical-lateral pickups, two preamplifiers with power supplies, wired and ready for operation. Code ZAFER.
- CB-4 Studio Combination.** Same as above but with lateral pickups. Code ZAFRE.
- CB-4 Studio Combination.** Same as above but with vertical pickups. Code ZAFTO.
- CB-4 Studio Combination.** Same as above but with WE 109A pickups. Code ZAFUV.
- CB-4 Studio Combination.** Same as above but with RCA MI-4875C pickups. Code ZAFWY.

SALES OFFICES

123 Hampshire St.
Quincy, Illinois

1350 North Highland Ave.
Hollywood 28, California

40 Exchange Place
New York 5, N. Y.

Distributors are conveniently located
in other sections of the United States



GATES RADIO COMPANY

MANUFACTURERS, ENGINEERS, SINCE 1922
QUINCY, ILLINOIS, U.S.A.

GATES
TRANSMITTING EQUIPMENT
ALL OVER THE WORLD

5M STUDIO EQUIPMENT

Present day broadcasting technique, even in relatively small stations, requires studio equipment with the diverse abilities for feeding two program lines (particularly when FM is added) recording, monitoring and auditioning—many times simultaneously. Standard consoles with self-contained amplifiers, although adequate for many stations, are deficient when considering the needs of some installations. To provide the necessities for today's broadcasters, the 5M is offered as it contains an exceedingly wide variety of facilities and will meet practically any set of requirements.

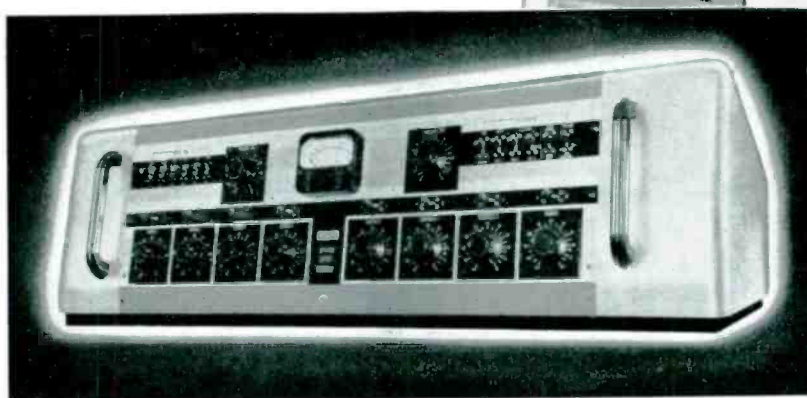
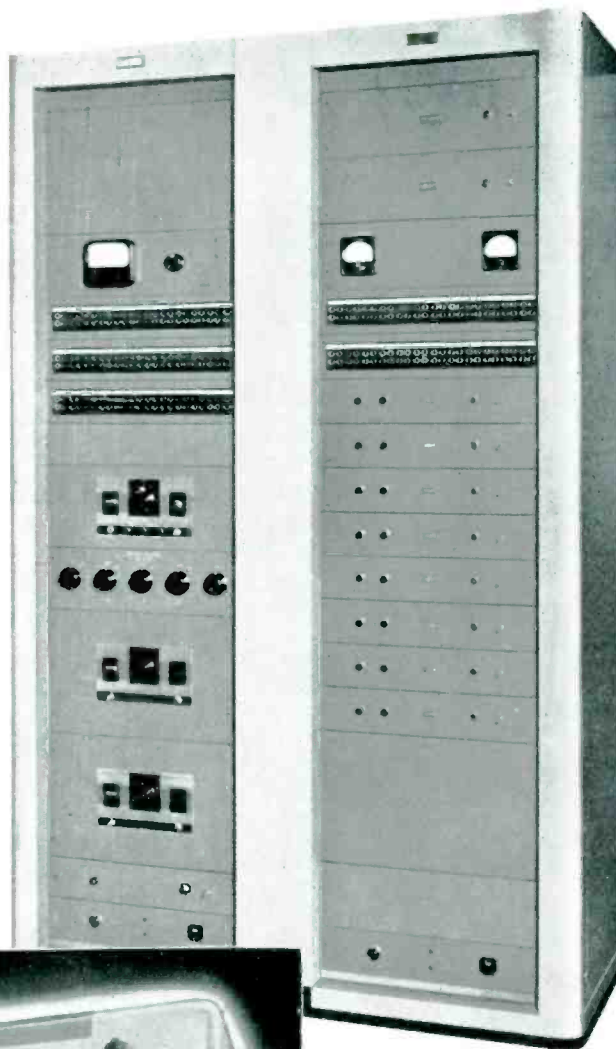

GATES RADIO COMPANY
MANUFACTURERS, ENGINEERS, SINCE 1922
QUINCY, ILLINOIS, U.S.A.

MANUFACTURERS, ENGINEERS, SINCE 1922
QUINCY, ILLINOIS, U.S.A.

GATES
GATES
TRANSMITTING EQUIPMENT
ALL OVER THE WORLD

and center joining pieces cover up mounting screws and slots, recess the panels and give the installation that distinctive appearance deserved by any station. Illumination sufficient for operation of the cabinet equipment is supplied by a lamp mounted in the top of each cabinet above a slot placed slightly ahead of the panels.

All the equipment is completely inter-wired before shipment with exception of connections between cabinets. Only wire with an exterior covering of braided shielding is used to assure low noise levels, low cross-talk, good grounding and neat appearance. Circuits to and from the 5M are terminated on telephone type terminal boards. Each termination is numbered and the designation is repeated in the instructions and drawings that accompany each equipment.

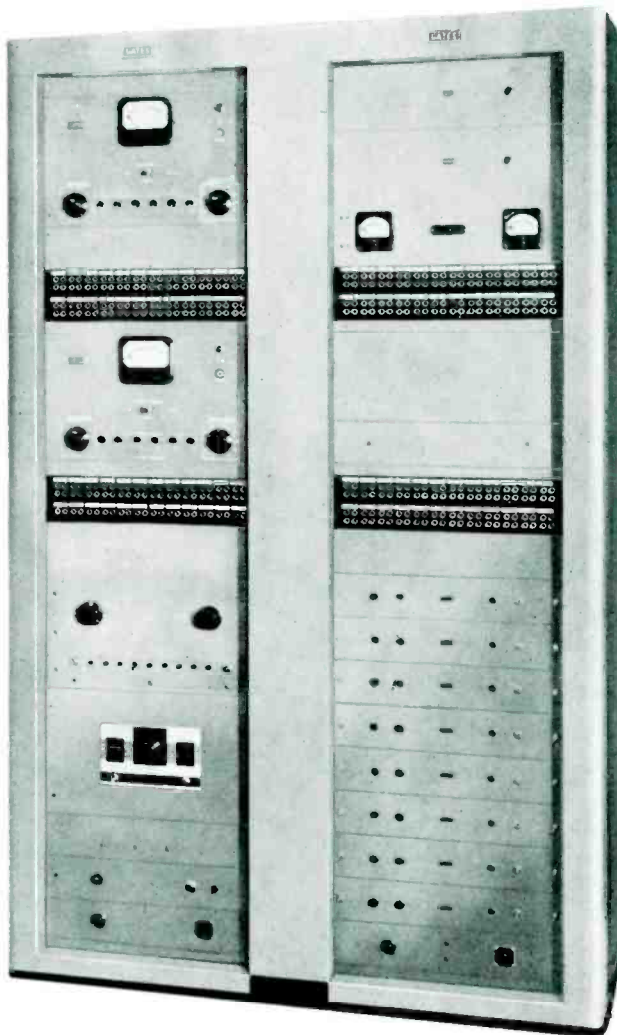

The above apparatus is a modification of the 5M equipment made for a prominent midwestern station. A recording channel was added and patching modified. Control was arranged for two consoles instead of the usual single console. Gates engineers are always ready to handle a special job of this nature. Your inquiries are invited.

GATES RADIO COMPANY
MANUFACTURERS, ENGINEERS, SINCE 1922
QUINCY, ILLINOIS, U.S.A.

GATES
TRANSMITTING EQUIPMENT
ALL OVER THE WORLD

Facilities

The variety of facilities in the 5M makes possible an almost endless combination of functions. Normally the equipment is used to feed a program to the transmitter, monitor the program and at the same time feed a recording channel or audition any other program. However, as all incoming and outgoing lines as well as the input and output circuits of each amplifier are brought to patch panels and normalled thru almost any conceivable audio system is readily available.

Although the 5M is arranged for simultaneous or separate feed to two program lines further flexibility may be obtained by adding a second MO-2694 line amplifier if desired. By so doing the two MO-2696 amplifiers are available for monitoring, auditioning or recording at all times as the additional MO-2694 amplifier is used to feed the second program line.

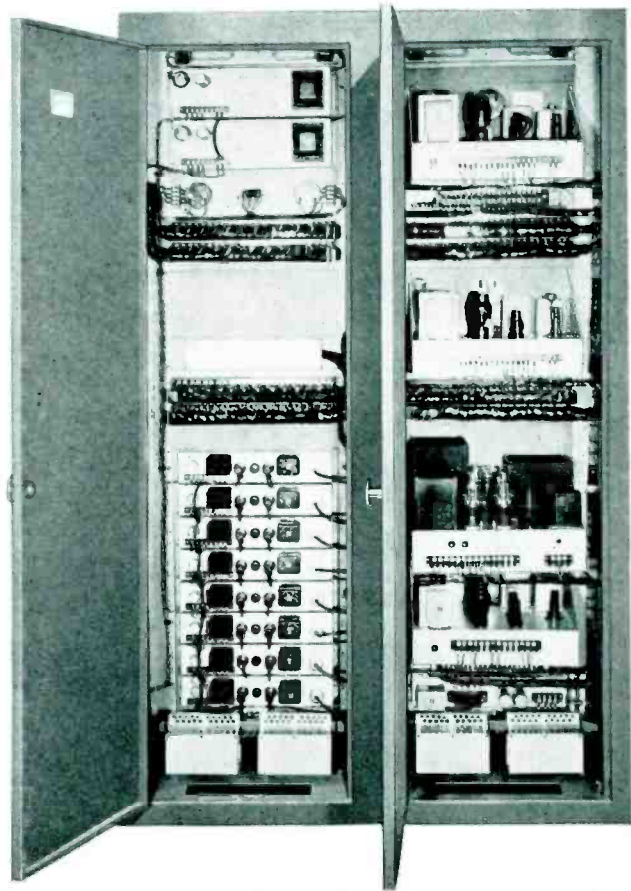

This is the rear view of the equipment shown on the opposite page. All wiring is neatly arranged and brought down to telephone switchboard type terminal blocks. Special instruction books and complete schematic drawings are always furnished on a project of this kind.

GATES RADIO COMPANY
MANUFACTURERS, ENGINEERS, SINCE 1922
QUINCY, ILLINOIS, U.S.A.

GATES
TRANSMITTING EQUIPMENT
ALL OVER THE WORLD

Patch Panels

All of the equipment in the 5M audio equipment is brought to the patch panels and most of the circuits are normalled thru so that most circuits may be set up by operating switches on the console. However, as the patching facili-

Below is an enlarged view of the patching facilities of the cabinet shown at the right. The patch panels used are the type C-1500-M1 providing facilities for getting to the input or output of any amplifier as well as many remote lines and the input and output circuits of the 31-B Console.

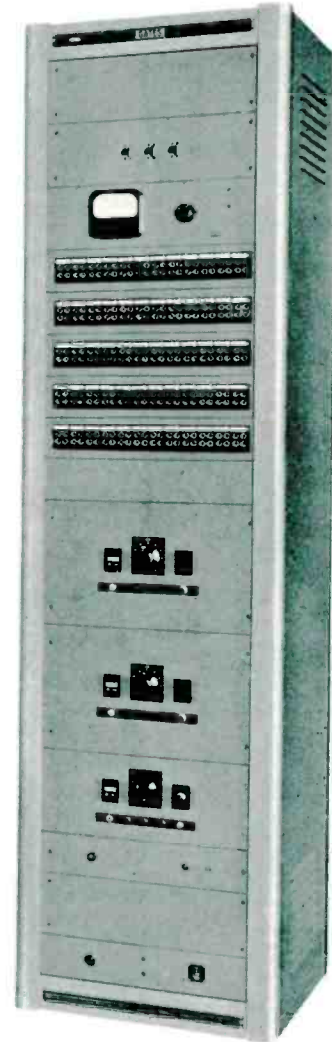
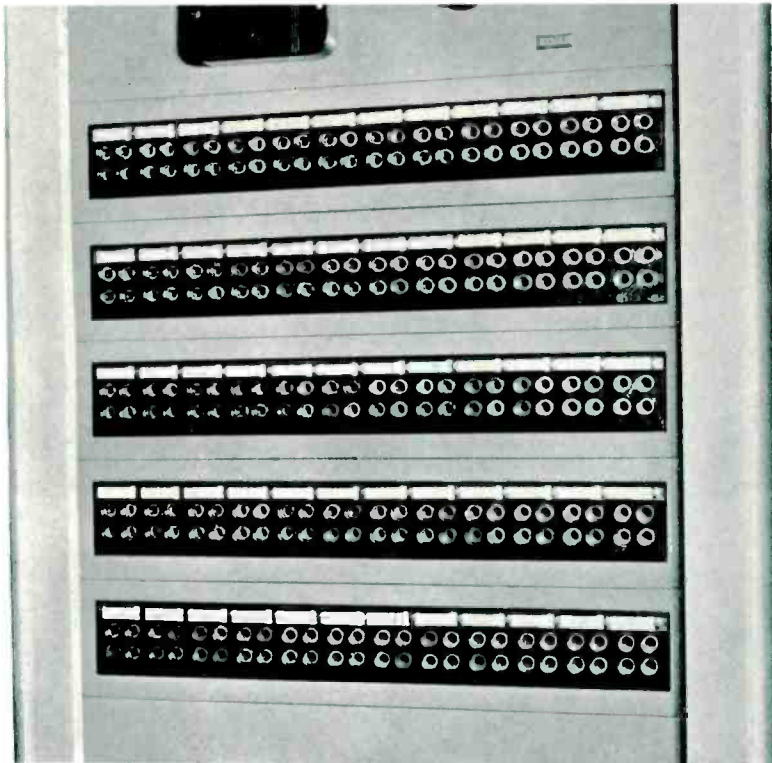

The cabinet above is in use in a new station in Pittsburgh. It is designed to provide to program channels plus audition and monitoring lines. The 31-B Console operates with it to supply additional facilities. All circuits are brought to the patch panels to provide the best flexibility. This is another example of a completely coordinated job designed for the particular requirements of the user.

GATES RADIO COMPANY
MANUFACTURERS, ENGINEERS, SINCE 1922
QUINCY, ILLINOIS, U.S.A.

GATES
TRANSMITTING EQUIPMENT
ALL OVER THE WORLD

ties are so complete and involve a great many circuits a compilation of these facilities is enumerated below for the sake of clarity:

1. Provision for plugging into the input and output circuits of each preamplifier, booster amplifier, program amplifier and audition and monitor amplifiers.
2. The output of any incoming studio line may be patched into any mixing circuit or amplifier.
3. Eight remote lines normal thru to the remote keys on the console with provisions for patching in eight extra remote lines.
4. One each 10, 20 and 30 Db. fixed attenuators, two line to line transformers, one bridging transformer and two groups of three multiple jacks.
5. A bridging jack on the program, audition and monitoring amplifier output circuits.
6. Provision for plugging into the speaker distribution panel input on audition or monitoring lines.
7. The VU meter may be patched into any line.
8. Eleven spare lines brought to the terminal board from the patch panels.

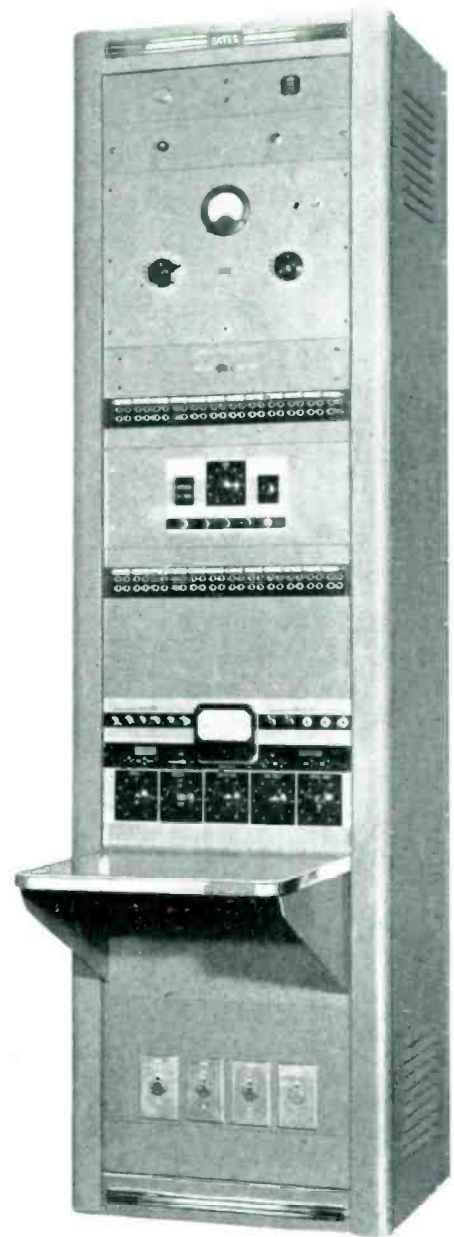

A new station in Pennsylvania got the above cabinet of equipment along with others of a completely co-ordinated factory wired installation. This type is different than the 5M but is shown here as one example of what can be done to supply a tailor-made installation to exactly fit your needs. The cabinet contains complete audio facilities for the transmitter installation to supplement those of the studios.

GATES RADIO COMPANY
MANUFACTURERS, ENGINEERS, SINCE 1922
QUINCY, ILLINOIS, U.S.A.



TRANSMITTING EQUIPMENT

SPECIFICATIONS

- FREQUENCY RESPONSE**—Plus or minus one db. from 30 to 15,000 cycles.
- NOISE**—60 db. below +18 VU output on the program channel and +38 VU output on the audition and monitoring channels.
- DISTORTION**—Program channel less than 1% at +18 VU, audition and monitoring channels less than 1% at +38 VU.
- GAIN**—Maximum of 105 db. from microphone and turntable input to program, audition or monitoring channel output. Approximately 45 db. gain from remote line input to program, audition or monitoring output.
- INPUT IMPEDANCES**—Microphones and Turntables—any standard impedance from 30 to 600 ohms; remote lines — 600 ohms.
- OUTPUT IMPEDANCES**—600 ohms from the program line or audition and monitoring amplifiers. 2500 ohms for each speaker channel.
- INPUT LEVEL**—Maximum of -40 VU to microphone and turntable channels. +8 VU for remote lines.
- POWER INPUT**—450 watts from 115 volt 50/60 cycle AC line. Other voltages and frequencies available on order.
- WEIGHT**—1150 lbs. net, 1500 lbs. packed for domestic shipment, 1750 lbs. packed for export.
- DIMENSIONS**—Each cabinet—23 $\frac{1}{8}$ " wide, 20 $\frac{1}{8}$ " deep, 78" high, approximately 48" wide when cabinets set side by side using connector strip.
Control Console—47" long, 15" high, 22" deep.
Packed for export—90 cu. ft.
- TUBE COMPLEMENT**—Each of eight preamplifiers—two type 6J7 tubes.
Each of two booster amplifiers—one 6J7, one 6C5.
Each audition and monitoring amplifier—three 6J7, two 6L6, one 5Z3.
Line amplifier—two 6J7, one 6F6, one 6X5.
- NOTE**—If an additional program channel is added the tube complement for an additional booster amplifier and a line amplifier is added.

5M Studio Equipment with one set of tubes and instruction book.
Code ZAETH.

SALES OFFICES

123 Hampshire St.
Quincy, Illinois

1350 North Highland Ave.
Hollywood 28, California

40 Exchange Place
New York 5, N. Y.

Distributors are conveniently located
in other sections of the United States.



GATES RADIO COMPANY

MANUFACTURERS, ENGINEERS, SINCE 1922
QUINCY, ILLINOIS, U.S.A.

THE STUDIOETTE CONSOLE



This is the kind of studio programming equipment that the smaller broadcaster needs to fill his every requirement. In the Studioette the customer gets a unit complete in itself that has the flexibility of larger and more expensive units and at the same time has appearance that will add to the "showmanship" of any station. It is ideally suited to use as a single studio unit in any large station.

MICROPHONE CHANNELS

Two mixing channels are available for studio microphones, each one having a switch above it so that two microphones can be used on each mixer. An announce position microphone is on a third mixer, used alternately with remotes. Input impedances may be of any standard value from 30 to 600 ohms.

TRANSCRIPTION CONTROLS

Two pickups may be fed into the single fader provided for this purpose. This is a "twelve o'clock off" type fader having full "on" positions to the full right or left rotation of the control. A switch directly above this control connects the pickups into the circuit.

GATES

TRANSMITTING EQUIPMENT



Front view of the Studioette with the cabinet removed. It may be mounted in a standard relay rack cabinet if desired.

REMOTE CHANNEL

Provision is made for six remote lines, each one of which is selected by a pushbutton in the upper left section of the panel. Gain is controlled by a separate mixer at the extreme right of the bottom row of controls. The mixer may also be switched to the above mentioned announce microphone, the output of which also may be fed to the remote line if desired for cueing purposes. The microphone and turntable channels may also be used for cueing.

MONITORING

Two switches and three phone jacks are mounted on the upper right portion of the front panel. The switch marked "A.F.—R.F." connects to the input of the monitoring amplifier, and may be switched to the output of the program amplifier or the output of the transmitter merely by placing the switch in the proper position. The jack marked "Order Phone" is used to connect an order phone in the conventional manner. Next is the jack marked "remote" which permits monitoring

the remote line with headphones. Headphones are also used to monitor the program line by plugging into the jack marked "line."

MASTER GAIN CONTROL

This control regulates the level going to the program line and consequently is used to govern the maximum output of the entire Studioette. The large VU meter on the front panel is connected to the output of the Studioette and is always in the program line. Its action is governed by the master gain control and shows accurately what audio level is being fed to the program line.

MONITOR AMPLIFIER

This unit is an integral portion of the power supply chassis. Two 2A3 tubes in pushpull are used in this amplifier thus providing high quality with more than enough power to drive four to six eight-inch speakers. They may be switched to the transmitter output or program output by throwing the switch marked A.F.—R.F. to the A.F. position to monitor direct from

GATES RADIO COMPANY
 MANUFACTURERS, ENGINEERS, SINCE 1922
 QUINCY, ILLINOIS, U.S.A.

GATES
TRANSMITTING EQUIPMENT
ALL OVER THE WORLD

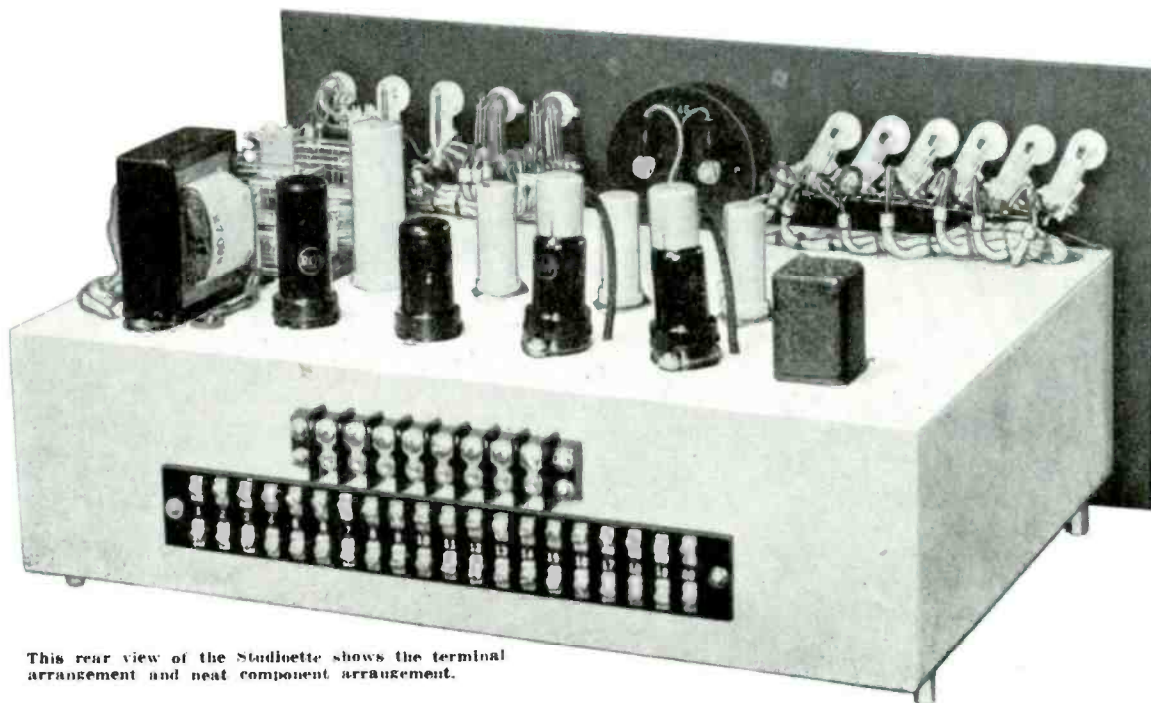

This rear view of the Studioette shows the terminal arrangement and neat component arrangement.

the program amplifier or to the R.F. position to monitor the output direct from the transmitter.

APPEARANCE

The front panel of the Studioette is finished in flat back trimmed in silver which gives it a very distinguished modern appearance. Knobs are of molded plastic and all scales and operational designations are in silver to match the trim. The cabinet is supplied standard in gray luster wrinkle but black wrinkle may be had on special order.

PROGRAM AMPLIFIER

This is a four stage unit consisting of two 6J7 tubes, one 6C5 tube, and one 6N7 tube. The circuit is conventional in every respect to take advantage of the good performance characteristics of well proven designs. Feedback has been incorporated to insure flat response from 30 to 10,000 cycles. The first stage is shock mounted to minimize microphonics.

POWER SUPPLY

The P-3 Power Supply consists of a 5Z3 tube operating as a full wave rectifier supplying current to a two section filter. The DC output from the P-3 supply is 150 millamperes at 300 volts total.

Filament power is also available from two windings, one being 2½ volts at 10 amperes, the other 6.3 volts at 5 amperes.

Both plate and filament supply connections are made to a numbered terminal strip at the back of the unit. Ordinarily, the P-3 power supply is furnished for mounting under a table, in a desk drawer or any other convenient spot. Relay rack mounting may be had if desired at slight extra cost.

The entire unit is finished in black wrinkle enamel. When supplied for rack mounting the panel may be either gray or any appropriate color required.

GATES RADIO COMPANY
MANUFACTURERS, ENGINEERS, SINCE 1922
QUINCY, ILLINOIS, U.S.A.

GATES
TRANSMITTING EQUIPMENT
ALL OVER THE WORLD

STUDIOETTE

TUBE COMPLEMENT: 2-6J7, 1-6C5, 1-6N7.
INPUT IMPEDANCE: Variable 30 to 600 ohms for microphones, 250 ohms for turntables, 500 ohms for remote circuit.
OUTPUT IMPEDANCE: 500-600 ohms.
OVERALL GAIN: 91 Db., microphone to program line.
DISTORTION: .7 of 1% measured at plus 8 DB. output.
FREQUENCY RESPONSE: Flat within 1 DB. from 30 to 10,000 cycles.
NOISE LEVEL: 55 Db. below program level of -14VU.

POWER SUPPLY

FILTER: Two section.
RECTIFIER TUBE: Type 80.
PLATE VOLTAGE AND CURRENT: 300 volts at 150 MA from output of first filter section; 300 volts at 40 MA from output of second section of filter.

GENERAL SPECIFICATIONS

DIMENSIONS: Studioette cabinet, 21¼ inches wide, 10½ inches high, 15 inches deep. Power supply and monitor amplifier unit, 9 inches wide, 8½ inches high, 16 inches long.
POWER REQUIREMENTS: 115 volt, 60 cycles AC. Other voltages or frequencies available and quoted on request.

When placing your order for a 51CS Studioette be sure to specify the impedance of the microphones and the type (high level or low level) of pickups that will be used. This information is very important as the circuits are arranged to operate with the type of pickups and microphones that you are using if we receive the information. Otherwise standard impedance of 250 ohms for microphones and pickups will be provided.

Studioette complete with tubes and power supply Code YUSYL.

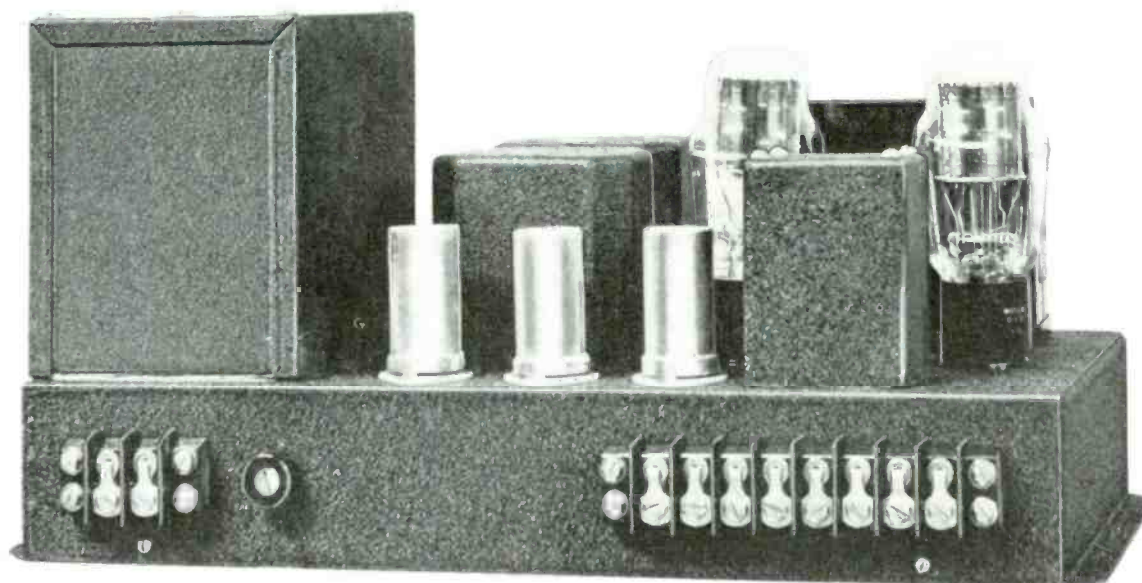

This is the power supply and monitoring amplifier chassis of the Studioette.
All components are generously proportioned.

GATES RADIO COMPANY
MANUFACTURERS, ENGINEERS, SINCE 1922
QUINCY, ILLINOIS, U.S.A.

STUDIO INDICATING FIXTURES



THE proper thing to put on the door or over the door to bring life to studio hallways or entranceways is always a problem. Gates has designed a series of fixtures shown herein that solves this problem, plus adding a distinct appearance in doing so. These fixtures are eye-catching and yet in no way are they gaudy. They will harmonize with any studio setting. The fixtures may mount above the door as per several suggestions shown in pen drawings on opposite page. The base is in medium brown and

will harmonize with walnut, maple, mahogany or oak. Plexiglass which will transfer the light rays edgewise through the glass is used for the lettered indication and letters show up the same color as the light in the base. In each of the permanently lighted fixtures such as "Studio A", etc., a yellow fluorescent light is used which gives a deep gold lettering. In the "On Air" fixture an incandescent light is used and the lettering "On Air" is in red so that this light will indicate instantaneously.

GATES
TRANSMITTING EQUIPMENT
ALL OVER THE WORLD

Usually the "On Air" fixture is used both in the studio and outside the studio door. The other fixtures are available in three standard letterings:

Studio A
Studio B
Control Rm.

However they may be had with any other lettering, but for best indication lettering should

be limited to a dozen or less letters. For those wanting to completely equip their entrances, identifying offices, wash rooms, news rooms, etc., this is very possible without delay.

Size is 18" wide and 7" high from top of glass to bottom. Depth is 3". Operate from 115 volts, 50-60 cycles. All are supplied with lights ready to attach to your wiring.

- Model AM1 — Reads "Studio A". Code word ZAHSA
- Model AM2 — Reads "Studio B". Code word ZAHTB.
- Model AM3 — Reads "Control Rm." Code word ZAHUX.
- Model AM4 — Reads "On Air." Code word ZAHWO.
- Model AM5 — Reads to your lettering request. Code word ZAHZY.

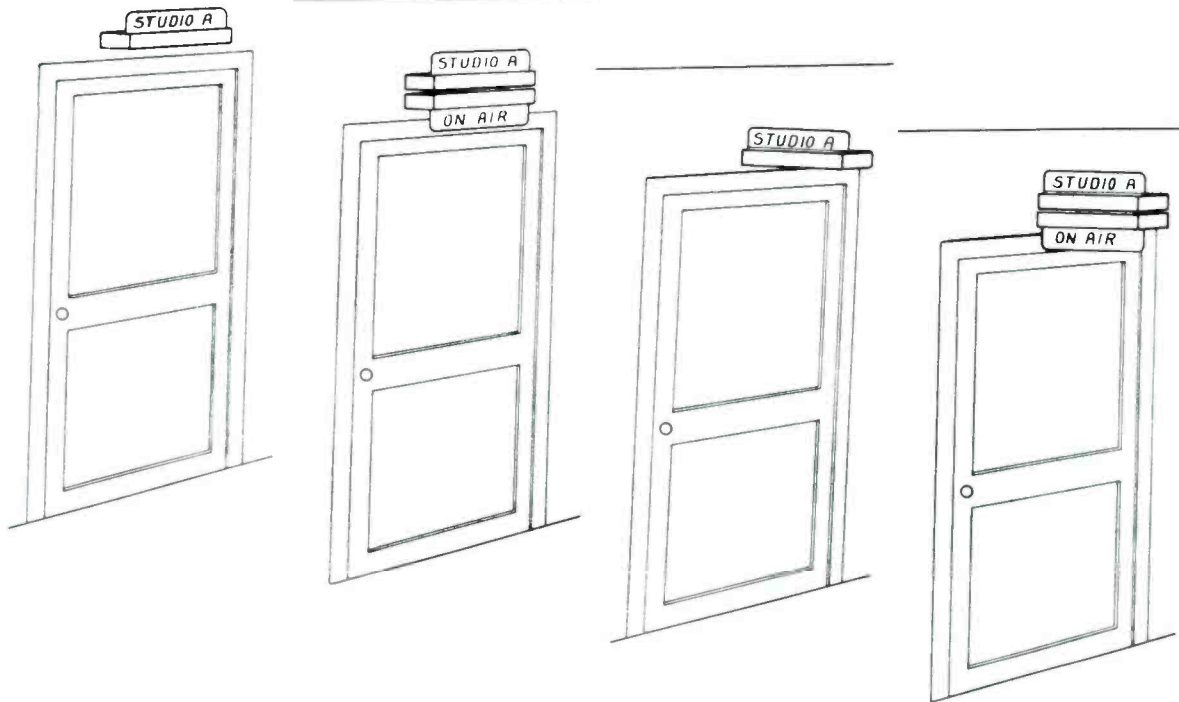

GATES RADIO COMPANY
MANUFACTURERS, ENGINEERS, SINCE 1922
QUINCY, ILLINOIS, U.S.A.

GATES
TRANSMITTING EQUIPMENT
ALL OVER THE WORLD

MODEL 6C BROADCAST AMPLIFIER

for

Line - Audition - Monitor - Recording - Repeater
Service

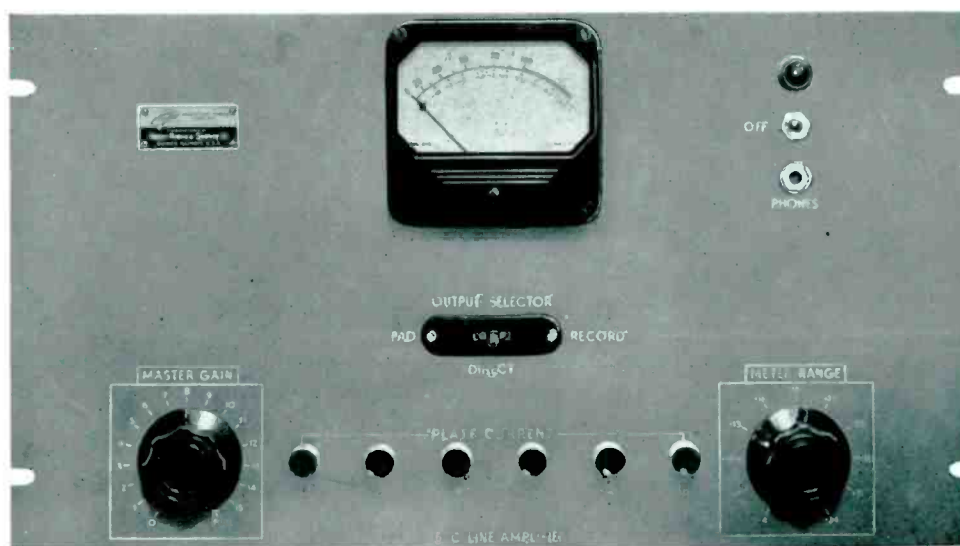

Model 6C Amplifier

THE Model 6-C amplifier is a flexible unit which may be used in recording, monitoring and line amplifier service. Because of this versatility, one type of amplifier can be used throughout the broadcasting station resulting in simplification and providing inter-changeability.

The 6-C amplifier has three audio stages, above average gain, wide and uniform frequency response and very low noise level. While desirable for other services, this high gain is limited when the device is

operated as a line amplifier by a fixed line pad which is an integral part of the amplifier.

The amplifier circuit proper will match to 50, 250 and 500 ohm input circuits and a special bridging transformer is available where it is desired to bridge the amplifier across a low impedance circuit without effecting the characteristics of the low impedance line. This transformer is a separate accessory and not part of the equipment. Three audio stages, all resistance coupled and employing a phase inverter circuit for push pull audio output are provided.

GATES RADIO COMPANY
MANUFACTURERS, ENGINEERS, SINCE 1922
QUINCY, ILLINOIS, U.S.A.

www.americanradiohistory.com

GATES TRANSMITTING EQUIPMENT ALL OVER THE WORLD

Inverse feed back from a separate secondary winding of the output transformer back to the cathode circuit of the second audio stage develops a very low distortion content at over 15 watts and resultant even better performance at lower output. Output is for a 500-600 ohm line. The master gain control is of the wiping contact type in the grid circuit of the first audio stage. In this manner there is no danger of overloading the first audio stage which is possible if the gain control is otherwise located. The input transformer is so designed that the primary may be balanced to ground except for 50 ohm impedance.

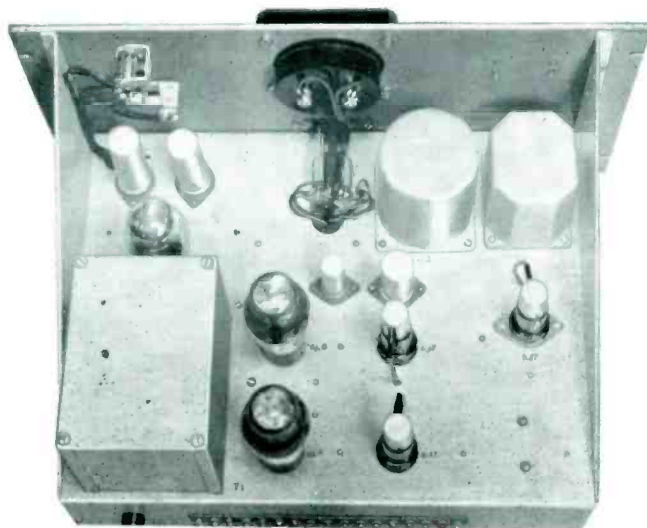

Fig. 2 — Rear 6C Amplifier

Push button metering of all plate currents is provided and metering is done externally. A metering panel for general use with all amplifiers of this type Model is available. Either a dual range meter or two separate meters having scales of 0-100 Ma, are used. Push buttons are of the make before break type and operate in the cathode circuit. A push button of the locking type is also part equipment which is in the volume indicator circuit and provided as a means of switching the volume indicator from the 6C amplifier circuit to any external circuit for other audio measurements.

The volume indicator is complete consisting of a 4" V.U. meter scale B with wiping contact T design range control in 2 V.U. steps from plus 4 to plus 34 V.U.. With this complete volume indicating complement the output level may be quickly adjusted for several types of service without guess work.

Provided as part of the 6C Amplifier is a three position output selector key. Two of these positions are high level for separate 500-600 ohm circuits conveniently designated as "Record" and "Direct" which may be used for recording, loud speaker or any other circuit such as a net work feed. A third output designated "Pad" reduces the output through a balanced H pad 20 Db. This circuit is usually used to feed a telephone line or lower level circuit. Each output circuit is brought to a separate pair of terminals thus allowing the 6C Amplifier to be instantly selective to 3 distinct load requirements.

The power supply is of the transformer type (no voltage doubler circuits) and employs resistance type filtering. Pilot light, starting switch and jack completes the manually controlled complement.

SPECIFICATIONS

Finish—Grey (deep steel gloss).

Size—12¼" high, 19" wide, 14½" deep.

Tubes used—Three 6J7 or 1620, two 6L6 or 1622 and one 80

Audio gain—74 Db. at outputs "Direct" and "Record" and 54 Db. at output "Pad."

Audio response—Flat within plus or minus 1 Db. from 30 to 10,000 cycles and plus or minus 2 Db. from 30 to 15,000 cycles.

Audio distortion—Less than 2% at 84 volts across 500 ohms (about 16 watts) less than 1% at plus 34 V.U.

Noise level—55 Db. below program level or better.

Line wattage—150.

Line voltage—115 volts 50-60 cycles.*

Input impedance—50, 250 or 500-600 ohms.**

Output impedance—500-600 ohms.

* May be had for other primary voltages and frequencies.

** Model 6CP-B transformer available for bridging 10,000 ohms with added gain loss of 10 Db.

Model 6C Broadcast Amplifier Code—YURIG

GATES RADIO COMPANY
MANUFACTURERS, ENGINEERS, SINCE 1922
QUINCY, ILLINOIS, U.S.A.

GATES
TRANSMITTING EQUIPMENT
ALL OVER THE WORLD

LINE AMPLIFIER

MO-2694

FM or AM

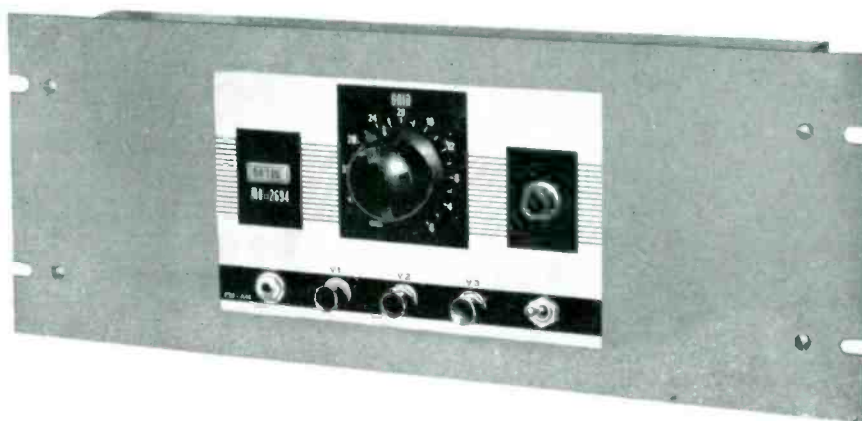

This amplifier easily satisfies fidelity requirements for AM broadcasting and also has the fine attributes necessary for FM systems. Its versatile termination arrangements, pleasing appearance and excellent technical qualifications are sure to find favor in any installation.

GATES RADIO COMPANY
MANUFACTURERS, ENGINEERS, SINCE 1922
QUINCY, ILLINOIS, U.S.A.

GATES
TRANSMITTING EQUIPMENT
ALL OVER THE WORLD

THE MO-2694 is designed to provide an output level of plus 15 VU over a frequency range of thirty to fifteen thousand cycles. The noise level, although somewhat dependent on input level, is minus forty decibels absolute or better. Distortion is one per cent or lower at output levels approximating plus twenty-five VU which makes possible taking advantage of the high signal to noise ratio (sixty decibels) at that output. Input levels may be as high as minus ten VU but attenuation circuits should be inserted in the line if higher input levels are to be used.

A barrier terminal strip is on the rear of the chassis to accommodate input and output connections and the 115 volt power line. A fuse in the primary of the power transformer protects the equipment against accidental overloads. The gain control, phone jack, meter push-buttons and power switch with red "bulls-eye" indicator are mounted on the styling plate on the front panel. Slots are located on the edges of the front panel to facilitate mounting in a cabinet designed to take panels nineteen inches wide and with standard drilling.

SPECIFICATIONS

- TUBE COMPLEMENT:** one 6J7 (triode connected)
one 6J7 (pentode connected)
one 6F6 (pentode connected)
one 6X5 (rectifier)
- FIDELITY:** 30 to 15,000 cycles \pm 1½ db.
- DISTORTION:** Less than 1% at an output level of + 22 VU.
- NOISE and HUM:** 40 decibels absolute below a reference level of .001 watt in a 600 ohm circuit. 65 decibels below an output level of + 25 VU, 55 decibels below an output level of + 15 VU.
- INPUT LEVEL:** Minus 10 VU or below for distortion of less than 1%.
- GAIN:** Approximately 60 db.
- INPUT IMPEDANCES:** Any impedance from 30 to 500 ohms available on the terminal strip.
- OUTPUT IMPEDANCES:** 250 or 500 ohms.
- POWER CONSUMPTION:** 60 watts approximately.
- POWER SOURCE:** 115 volts, 60 cycles.
- DIMENSIONS:** 7 inches high, 7½ inches deep, 19 inches wide.
- WEIGHT:** 24 lbs., Net, 28 lbs. packed for domestic shipment, 45 lbs. (approximate) packed for export.
- MO-2694 Line Amplifier with tubes — Code ZABEN.

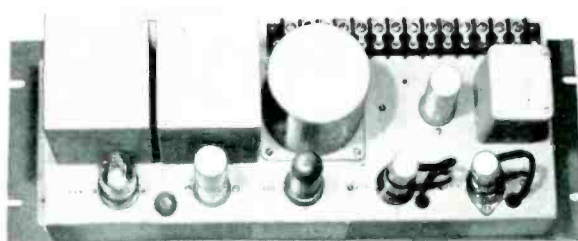

Rear view MO-2694 Amplifier

GATES RADIO COMPANY
MANUFACTURERS, ENGINEERS, SINCE 1922
QUINCY, ILLINOIS, U.S.A.

GATES
TRANSMITTING EQUIPMENT
ALL OVER THE WORLD

MULTI-PURPOSE AMPLIFIER

MO-2696

MONITORING — RECORDING — FM or AM

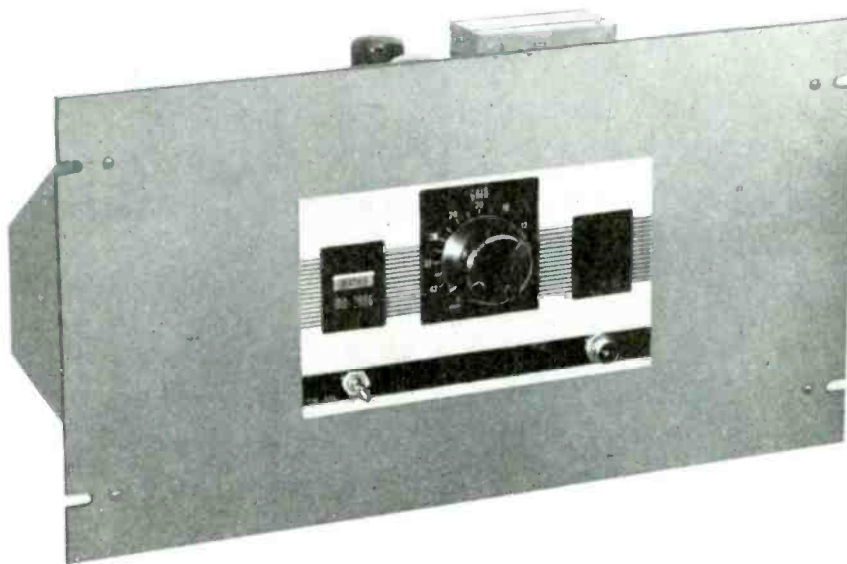

This amplifier can fill many services in any radio station. It has ample power for driving many speakers and most recorders, and the high fidelity needed for AM or FM installations.

GATES RADIO COMPANY
MANUFACTURERS, ENGINEERS, SINCE 1922
QUINCY, ILLINOIS, U.S.A.

TRANSMITTING EQUIPMENT

THE MO-2696 amplifier provides ten watts output at less than one per cent distortion in the frequency range of thirty to fifteen thousand cycles. Carefully balanced circuits, inverse feedback and high quality components combine to accomplish these results.

Input impedances of fifty, two hundred, five hundred, and twenty thousand ohms as well as output impedances of five hundred and also eight ohms are brought out to a barrier type terminal strip on the rear. Terminals are also on this strip for ground and the one hundred and fifteen volt, sixty cycle A.C. power source. Audio signal levels up to zero VU may be applied to the input circuits with the exception of the twenty thousand ohm bridging input which will accommodate inputs up to plus fifteen VU. The output level for one per cent distortion or less is approximately plus forty VU (ten watts), however in applications that can tolerate up to five per cent distortion the output level can be as great as plus forty three VU (twenty watts).

The MO-2696 amplifier is finished in grey and is attractively styled by an etched panel in the center. Standard nineteen inch relay rack slotted openings are provided.

SPECIFICATIONS

- TUBE COMPLEMENT:** First stage—one 6J7 (triode connected).
 Second stage—one 6J7.
 Phase inverter—one 6J7.
 Power output—two 6L6.
 Rectifier—one 5Z3.
- FREQUENCY RESPONSE:** Within one decibel from 30 to 10,000 cycles. $\pm 1\frac{1}{2}$ decibels, 30 to 15,000 cycles.
- NOISE LEVEL:** 70 decibels below + 40 VU output with gain full on.
- DISTORTION:** 1% at + 40 VU output. 5% at + 43 VU (20 watts).
- GAIN:** 70 db. using 50, 200, or 500 ohm input impedance. 55 db. using 20,000 ohm bridging input.
- INPUT IMPEDANCES:** 50, 200, or 500 ohms nominal. 20,000 ohms bridging.
- OUTPUT IMPEDANCES:** 500 or 8 ohms.
- INPUT LEVEL:** 0 VU for less than 1% distortion using 50, 200, or 500 ohm inputs. + 15 VU using 20,000 ohm bridging input.
- POWER INPUT:** Approximately 120 watts from 115 volt, 60 cycle source, other voltages and frequencies available on special order.
- NET WEIGHT:** Approximately 35 lbs.
- GROSS WEIGHT:** Approximately 40 lbs. when packed for domestic shipment, 55 lbs. packed for export.
- DIMENSIONS:** 10½ inches high, 13½ inches deep, 19 inches wide.
- CONTROLS:** Audio gain, Power "on-off" switch, pilot light behind red "bulls-eye."
- MO-2696 Amplifier with tubes.—Code ZABIP.**



Rear view MO-2696 Amplifier

GATES RADIO COMPANY
 MANUFACTURERS, ENGINEERS, SINCE 1922
 QUINCY, ILLINOIS, U.S.A.

MODEL 28C0 LIMITING AMPLIFIER

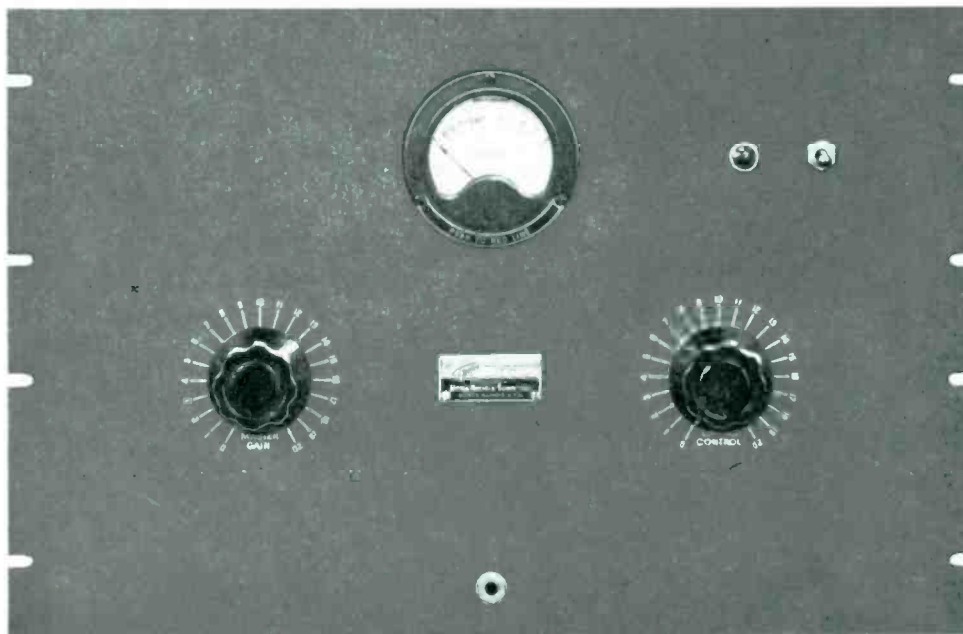

A Modern Engineering Development in:

- Low Distortion
- Limiting Action
(a dual limiter circuit)
- Compactness and Trouble-free Performance

GATES

TRANSMITTING EQUIPMENT

Model 28CO Limiter Detail . . .

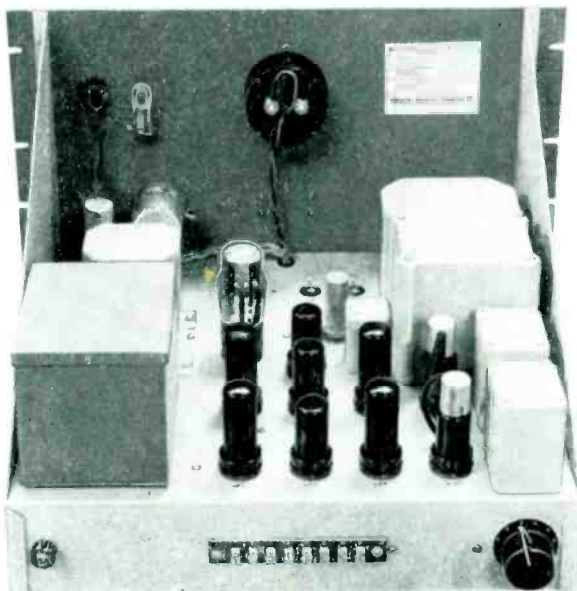

Fig. 2—Rear 28CO

THE Model 28CO Limiting Amplifier when properly used with broadcast equipment gives the effect of doubling the power of the transmitter. Where a limiting amplifier is not used, the audio level must be kept low enough to prevent overmodulation at the peaks. By limiting audio peaks by 3 decibels, with a limiting amplifier, the percent of modulation is increased and this provides a greater audio level at the point of reception. The result is a more effective signal and wider coverage.

The 28CO Limiting Amplifier utilizes a combination of two widely used limiting circuits combined as one which has brought about a unit that may be used at high compression levels with little more distortion content than at no compression. A combination of the differential bridge and the electronic (suppressor grid) circuit is employed. The differential bridge consisting of a circuit built around 60 Ma. lamps offers a pure resistance. A conventional tube rectifier which rectifies a portion of the output audio voltage and which applies it to the suppressor grids of the first audio stage. This provides very fast action for initial peaks while higher levels of compression are handled by the differential bridge

circuit thus assuring low distortion even at higher compression points.

A release timing switch (see figure 2) is on the back of the chassis providing three different release cycles. These may be selected at the installing engineers discretion and are adjustable from 50 to 300 milliseconds. Effect time has been set at approximately 15 milliseconds.

The amplifier has four audio stages divided into two complete amplifiers. The first two stages are used entirely for development of the limiting action while the final two stages are for voltage gain. The overall gain of the 28CO equipment is about the same as a 2 stage amplifier. There are two controls on the front panel one of which is the limiter control and is used for normal gain adjustments so that the incoming signal to the amplifier may be adjusted to keep the limiter indicating meter peaking properly. The remaining control is termed the master gain control which might better be called a modulation adjustment control as after once adjusted for modulation percentage, it is seldom changed. The indicating meter is a high speed 3½" decibel meter calibrated with a red line on the scale at which point 3½ decibels of compression takes place. By swinging the meter above this point higher amounts of compression are had. Head phone jack, pilot lamp and starting switch complete the panel complement.

Finish is in a deep gloss steel grey with chassis of light grey properly lettered. Vertical type rear chassis construction is employed. Power supply is self contained and compounds are all cased and impregnated for long life and conservative temperature rise.

SPECIFICATIONS

Size—19" wide, 12¼" high and 14½" deep.
 Tubes used—Four 6F6, two 6J7, three 6C5, one 80.
 Audio response—Flat plus or minus 1 Db. 30-10,000 cycles and plus or minus 2 Db. 30 to 15,000 cycles.
 Distortion—2% or less up to 5 Db. compression.
 5% or less to 8 Db. compression.
 Noise—55 Db. or better below program level.
 Gain—50 Db.

Minimum input level—Negative 20 Db.
 Maximum output level at distortion ratings—Plus 30 Db.*
 Input and output impedance—For 500-600 ohm line.
 Power line—115 volts 50-60 cycles.**
 Wattage consumed—150.
 Limiter effect time—Approximately 15 milliseconds.
 Release time—Three positions of 50, 150 and 300 milliseconds.

* Reference .006 watts. ** Special line voltages may be had with minimum delay and only slight extra cost.
 Catalog No. 28CO—Limiting Amplifier—Code word YUROH.

GATES RADIO COMPANY
 MANUFACTURERS, ENGINEERS, SINCE 1922
 QUINCY, ILLINOIS, U.S.A.

GATES TRANSMITTING EQUIPMENT
 ALL OVER THE WORLD



Front View—Model 60A Preamplifier

MODELS 60A AND 61A PREAMPLIFIERS

Identical characteristics are built into these two preamplifiers except that the 61-A has the added feature of a gain control so that when it is used for preamplification in a transcription pickup circuit its output level may be adjusted to equal other transcription pickup circuits in the installation.

Two stages of amplification terminated at both input and output by high quality transformers give high fidelity response within less than one decibel over a wide range of frequencies. Noise and distortion are well below the usual requirements for this type of apparatus.

The chassis is held to the panel by two knurled thumb screws which are easily removed for examination of components. A pleasing shade of gray enamel is used for finishing the panel. Connections for plate and filament voltages and output are located on a terminal strip on the rear. Input terminations are provided by an octal plug and socket assembly also mounted on the back. An "on-off" switch and pilot light control the filament circuit. Pushbutton switches on the front and are used to connect an external milliammeter for measuring plate current in each stage. Terminals for the meter circuit are on the rear.

SPECIFICATIONS

- TUBES: Two 6J7.
- GAIN: 40 db. maximum.
- OUTPUT: Maximum for 1% distortion 0 vu.
- DISTORTION: Less than 1% at 0 vu. output.
- FREQUENCY RESPONSE: + or - 1 vu. from 30 to 15,000 cycles.
- NOISE: Better than 60 db. below maximum output.
- POWER REQUIREMENTS: Approximately 5 ma from 180/250 volt dc. supply for B+. 6.3 volts A.C. at 6 amps. for filaments.
- DIMENSIONS: Mounts in standard 19" relay rack, panel height 3½", depth behind panel approximately 5".
- INPUT IMPEDANCES: 30/50, 200/250 and 500/600 ohms. All impedances terminate on octal socket in rear. Wire to plug supplied for the desired impedance according to directions.
- OUTPUT IMPEDANCES: 500/600 ohms as wired to terminal strip. 30/50 or 200/250 ohms available on output transformer as desired and is easily changed in the field.
- 60 A Preamplifier complete with tubes. Code YUVUM.
- 61 A Preamplifier complete with tubes. Code YUVYN.

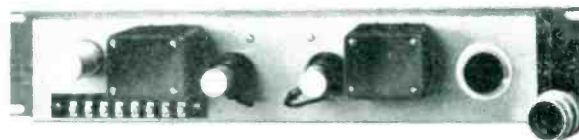

Rear View—Model 60A Preamplifier

GATES RADIO COMPANY
 MANUFACTURERS, ENGINEERS, SINCE 1922
 QUINCY, ILLINOIS, U.S.A.

TRANSMITTING EQUIPMENT

MODEL 61B PREAMPLIFIER

This preamplifier is designed to furnish ample gain for any transcription pickup to bring the level up sufficiently to feed a line amplifier. One of its most popular applications is to supplement the amplification facilities in the Model 30 Console when low level pickups are to be employed in the system. In this case, one of the 61-B units may be installed in each end of the console cabinet. Each preamplifier is then connected between the pick-up and the input terminals for transcription pick-ups on the 30 Console to give the channel additional gain.

A volume control is incorporated to enable balancing the outputs and adjusting gain.

Electrically, the circuit consists of two stages of amplification terminated at the input and output by high quality transformers. The chassis is sturdily constructed of steel and finished in a pleasing shade of gray.



SPECIFICATIONS

TUBE COMPLEMENT: First amplifier 6J7, second amplifier 6C5.

OUTPUT: Maximum for 1% distortion. +4 vu.

DISTORTION: Less than 1% at +4 vu. output.

FREQUENCY RESPONSE: + or - 1 decibel from 30 to 15,000 cycles.

NOISE: Better than 65 db. below maximum output.

INPUT IMPEDANCE: Normally wired for 200/250 ohms. Can be changed to 30/50 or 500/600 by changing connections on the input transformer.

POWER REQUIREMENTS: Approximately 5 ma from 180/250 volt dc. supply and 6.3 volts at .6 amps for filaments.

DIMENSIONS: 10" long overall, 5 inches wide, approximately 5 inches high.

61B Preamplifier complete with tubes. Code YUWAJ.

MODEL SC1 POWER SUPPLY

The SC-1 power supply was designed with the specific application in mind of supplying plate and filament power to low level preamplifiers. To assure essentially pure dc, a double section filter having the proper proportions of inductance and capacity is used. This contributes substantially to the low noise level that is inherent in any of our preamplifiers.

The chassis and panel are of steel, finished in harmonizing shades of gray. A toggle switch and red "bull's eye" indicate when the unit is in operation. All connection are made to a terminal strip on the rear.



SPECIFICATIONS

RECTIFIER TUBE: Type 80.

OUTPUT VOLTAGES AND CURRENT: 250 volts DC at 50 ma., 6.3 volts 60 cycles AC at 3 amperes.

DIMENSIONS: 5¼ inches panel height, 19 inches long. Approximately 6 inches deep.

SC-1 Power Supply complete with tubes. Code YUWEK.

GATES RADIO COMPANY
 MANUFACTURERS, ENGINEERS, SINCE 1922
 QUINCY, ILLINOIS, U.S.A.

Volume Indicator Panels

Series 7

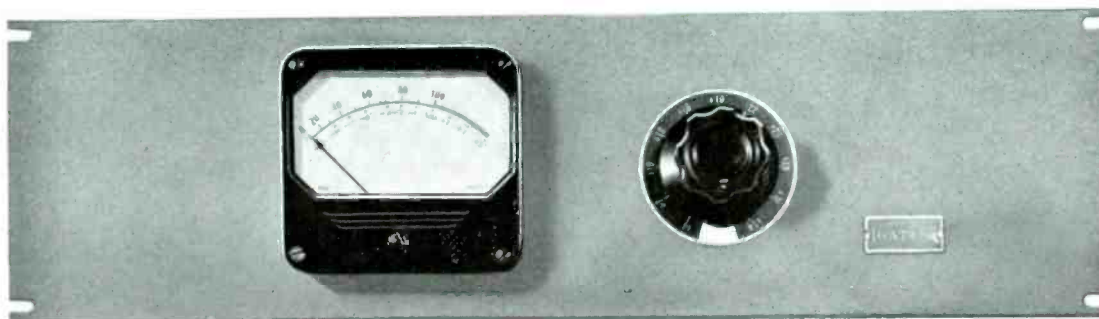

The volume indicator is a necessary part of every radio broadcasting station as well as telephone communications transmitting plant. The main value is reading volume level of the transmitted program but likewise it is equally valuable in taking frequency response measurements, checking level of incoming remote lines and making comparative level measurements of various circuits where the level must be the same.

Many broadcasting stations prefer two volume indicators so that both input and output reference levels can be taken when making frequency response measurements or where one unit is in use for program level indication, the other may be used for other purposes.

The Series 7 Indicators employ full-size 4-inch

V.U. meter, scale B, which is the standard of the industry for measurement purposes. It is very popular because of its easy readability, accuracy, fast upswing, lack of overshoot and slower back swing action, thus making the reading of program level easy to follow. The range extending attenuator used is a Tee network having wiping contacts representing a load of 7,500 ohms across a 600 ohm line. Accuracy of the attenuator range steps is plus or minus one per cent.

Panel size is 5¼ inches by 19 inches. Finish is in Gates grey though other colors may be had if required. As several range extending attenuators are available, the listing below gives the information on the various ratings obtainable.

- | | |
|---|------------------|
| Model 7-C: Range plus 4 to plus 34 V.U. in 3 V.U. steps. | Code word YURUJ. |
| Model 7-D: Range plus 4 to plus 34 V.U. in 2 V.U. steps. | Code word YURYK. |
| Model 7-E: Range plus 4 to plus 46 V.U. in 2 V.U. steps. | Code word YUSAF. |
| Model 7-F: Range plus 4 to plus 44 V.U. in 1 V.U. step. | Code word YUSEG. |

METER PANELS

Models M-100 and M-101



This panel contains two DC Milliammeters and one DC Voltmeter and is commonly installed with relay rack equipment for the purpose of measuring the voltages and currents in vacuum tube circuits.

One of the milliammeters has a range of 10 ma. and the other is 100 ma. full scale reading. The voltmeter measures up to 500 volts and has a sensitivity of 1,000 per volt.

The unit illustrated is the M-100 using American Standards Association round three-inch

meters mounted on a 5½-inch steel panel. The notched ends permit mounting on any standard 19-inch relay rack. Model M-101 is identical with the exception that the meters are of the square case design. Cobalt gray is the standard color for these panels. Other colors can be provided on special order. In order to obtain the best match a sample chip should be supplied.

Units containing meters having different scale ranges or for use on alternating current may be incorporated. Inquiries for such arrangements are solicited.

Model M-100: Meter Panel. Code word YUVNY.

Model M-101: Meter Panel. Code word YUVOL.

PATCH PANELS AND CORDS

PATCH PANELS

Series A---Two circuit, open

Series B---Two circuit, interlock

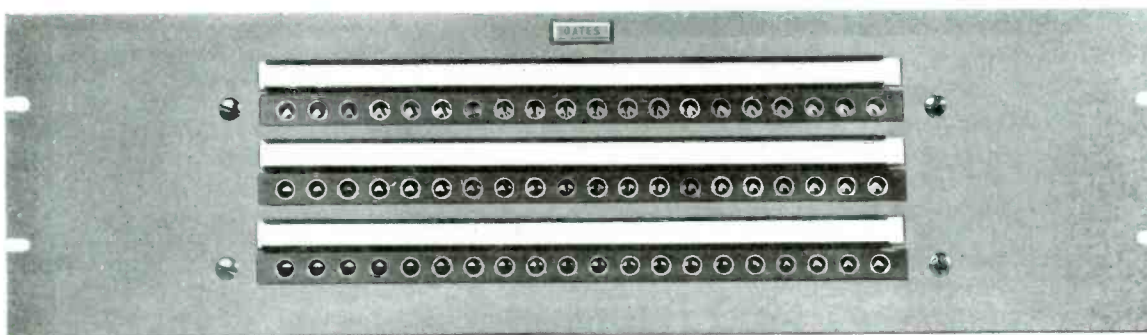

A-1301 and B-1101 Patch Panel

Series A and B patch panels are available in single, double, or triple row assemblies, each row containing twenty jacks. A designation strip is mounted above each row. The panels are made of 3-16" steel slotted to facilitate mounting in standard 19" relay racks. A pleasing shade of grey enamel is baked on to produce a durable finish.

GATES
TRANSMITTING EQUIPMENT
ALL OVER THE WORLD



A-130 and B-140 Patch Panel

The jacks used in these panels are of very high quality manufactured by one of the largest independent producers of telephone equipment and thereby assure the user of a finely constructed, long wearing piece of equipment.

Series A panels have open two circuit jacks of

the type commonly used when terminating telephon lines. Series B panels have the interlock type of jack commonly used to "normal" a circuit "to" and "from" the jack unless a patch plug is inserted in which case the incoming circuit is then brought out on the patch cord.

Open Circuit Types

- A-130 Single row patch panel, Code—YUKUB.
- A-1300 Double row patch panel, Code—YUKVA.
- A-1301 Triple row patch panel, Code—YUKWE.

Interlocked Circuit Types

- B-140 Single row patch panel, Code—YUKZO
- B-1400 Double row patch panel, Code—YULBO.
- B-1401 Triple row patch panel, Code—YULIZ.

Mounting Space Requirements

- Single row types 3½ inches.
- Double row types 3½ inches.
- Triple row types 5¼ inches.

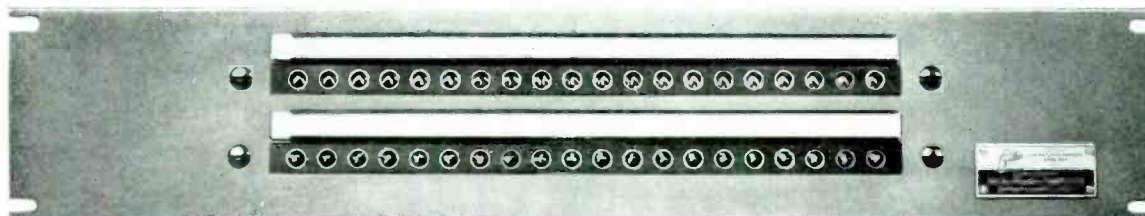

A-1300 and B-1400 Patch Panel

GATES RADIO COMPANY
MANUFACTURERS, ENGINEERS, SINCE 1922
QUINCY, ILLINOIS, U.S.A.

Series C Patch Panels

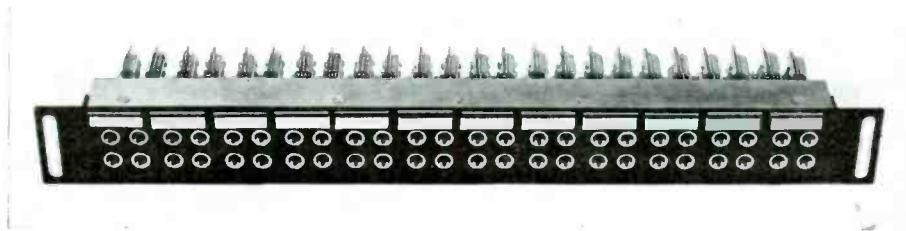

C-1500 Patch Panel

Series C patch panels are designed for use with standard double plug patch cords as shown below. Pairs of holes are spaced so that it is impossible to insert the plug in adjacent holes associated with two different circuits. Steel reinforced bakelite strips are used for the panels to obtain strength and rigidity. The end brackets are of slotted steel and will fit on any standard 19" relay rack cabinet. Design-

nation strips that can be easily removed and replaced are provided along the top of each strip.

Series C-150 is a single row strip having twelve pairs of jacks and requires $1\frac{3}{4}$ inches of panel mounting space whereas Series C-1500 is a double row panel having twenty-four pairs of jacks and requires $2\frac{1}{8}$ inches of mounting space.

C-150 patch panel, Code—ZABYS.

C-1500 patch panel, Code—ZACAN



C-150 Patch Panel

PATCH CORDS

Type D

These patch cords are designed to work with either Series A or B patch panels. The cord proper consists of a low capacity dual conductor cable shielded with a closely woven copper braid covered overall by a durable fabric that will resist abrasion. Plugs are the ring, tip and sleeve type having the sleeve connected to the shielding and the ring and tip to the two inner conductors.



Type D patch cord, 24 inches long. Code—YULOB.

Type E

This series of patch cords is designed for use with Series C patch panels. The cord is made from the highest quality tinned copper wire well shielded and insulated and is covered overall by a durable black braid reinforced six inches on each end. Plugs are precision machined to accurately fit any standard jack panel of the double hole type. The sleeves are grounded on the shield of the cord. Standard lengths of cords are 2, 4, and 6 feet, however other lengths are available on special order.

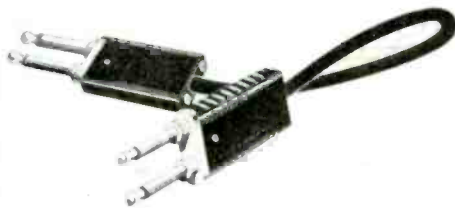

Type E-2 patch cord, 2 feet long. Code—ZACEP.

Type E-4 patch cord, 4 feet long. Code—ZACNA.

Type E-5 patch cord, 6 feet long. Code—ZACOR.

GATES
TRANSMITTING EQUIPMENT
ALL OVER THE WORLD

MODEL CB-10 MASTER TRANSCRIPTION EQUIPMENT

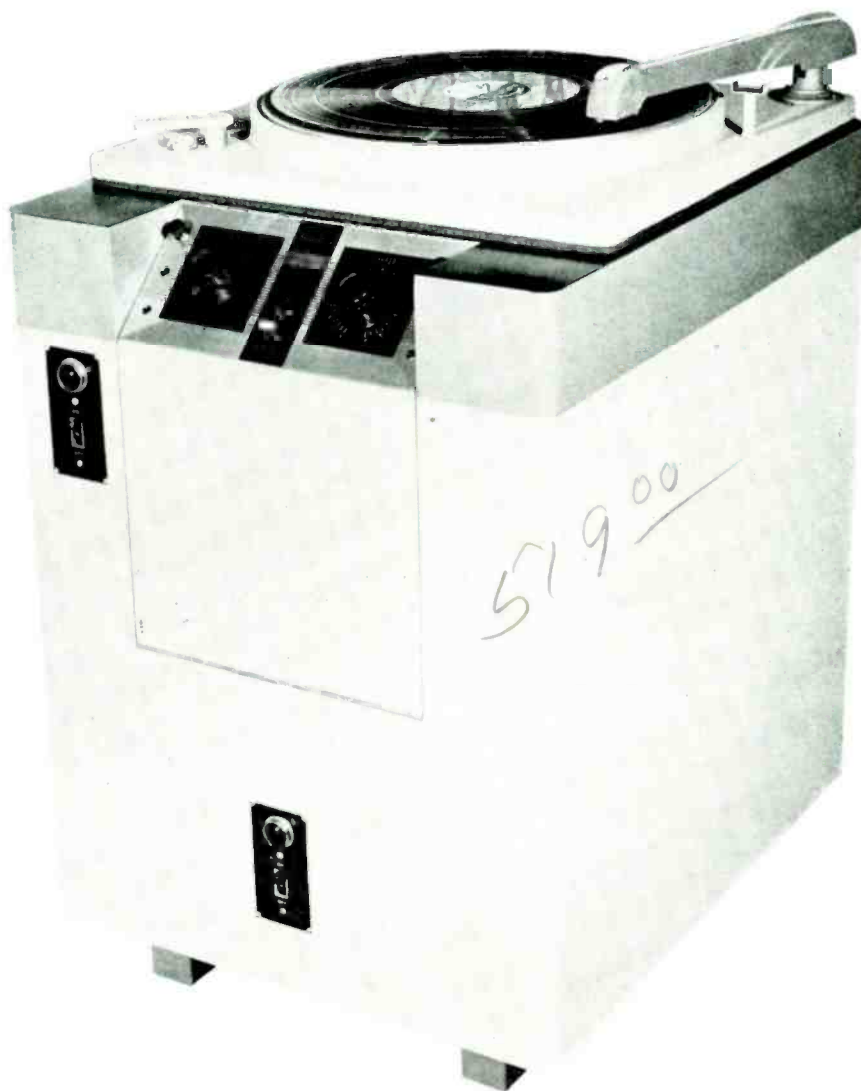

The complete transcription console ready to use without need of preamplification or mixer.

GATES RADIO COMPANY
MANUFACTURERS, ENGINEERS, SINCE 1922
QUINCY, ILLINOIS, U.S.A.

www.americanradiohistory.com

GATES
TRANSMITTING EQUIPMENT
ALL OVER THE WORLD



Close up of master control panel on Gates CB-10 equipments showing a new and revealing way to better turn table operation.

The Gates CB-10 Master Transcription Equipment is a complete, self-contained, modern equipment for faithful reproduction of all types of transcriptions. It is supplied with pre-amplifiers, power supply, fader, broadcast-cue switch and the new Gates CB-11 turntable mechanism all arranged into a convenient operating arrangement. Broadcasters everywhere have praised it as the only complete turntable manufactured today.

GATES RADIO COMPANY
MANUFACTURERS, ENGINEERS, SINCE 1922
QUINCY, ILLINOIS, U.S.A.

TRANSMITTING EQUIPMENT

The Complete CB-10 is quite like the master control desk in speech control. It is a master turntable from which point all operations can take place. With a microphone placed beside the CB-10 the announcer may have complete control of his program or for control room operation the technical staff is given a new type of operation, completely independent of speech control equipment with independent fading and cueing and so arranged that one or a dozen units may be used without taxing a single channel of the speech control apparatus.

Pick Ups Supplied are entirely to your choice. Gates has provided three types as standard for either vertical-lateral, lateral only or vertical only but the CB-10 Master Transcription equipment may be had with RCA or WE pick-ups also where the customer has specific preferences. For the all purpose turntable the Gates CB10A with universal vertical-lateral pick up may be desired. For those with lateral service predominate in their libraries the CB10 is specially designed to provide all the brilliance and color possible for exclusive lateral operation and likewise where the library is vertical only the CB-10B turntable with a specially designed vertical pick-up keyed to highest fidelity vertical quality is available.

Important is the feature that all pick-ups have plug-in heads and if you select lateral only and desire vertical later you need only procure vertical heads and the same is true for conversion to universal service. The equalizers are identical for all types and thus nothing else is required but changing heads. For those that have all vertical libraries or all lateral but desire provision for emergency playing of the opposite form of their library, they may procure an additional head which may be plugged in when this service is required thus giving them all the extra quality from pickups designed for a specific purpose. Many radio stations will operate for days, for example, from their vertical library but desire lateral provisions just in case of need. Where this is the case the CB10B units for vertical operation should be purchased and one or more extra lateral heads, which may be plugged in instantly, and in so doing all the fineness of the vertical service without lateral component in the reproduction is had. The same is identical where lateral is featured and vertical is desired for emergency requirements only the CB10 unit is purchased with added vertical plug in heads.

Where the service is balanced between vertical and lateral two choices are offered, (a) the use of the universal pick-up or the procurement of individual turntables for each service.

The Mechanism is very important as every broadcaster knows. Wows, rumble and clumsy design are intolerable. In the new CB11 chassis used in all new Gates turntables Gates engineers spent nine months in the study of casting design to eliminate points of harmonic generation which is the major cause of rumble. Goodyear engineers were called in to design drive wheels with the proper shore hardness for power transmission and the motor manufacturer was called upon to design a noise and vibration free motor. Four of these turn tables supplied nearly all programs to one

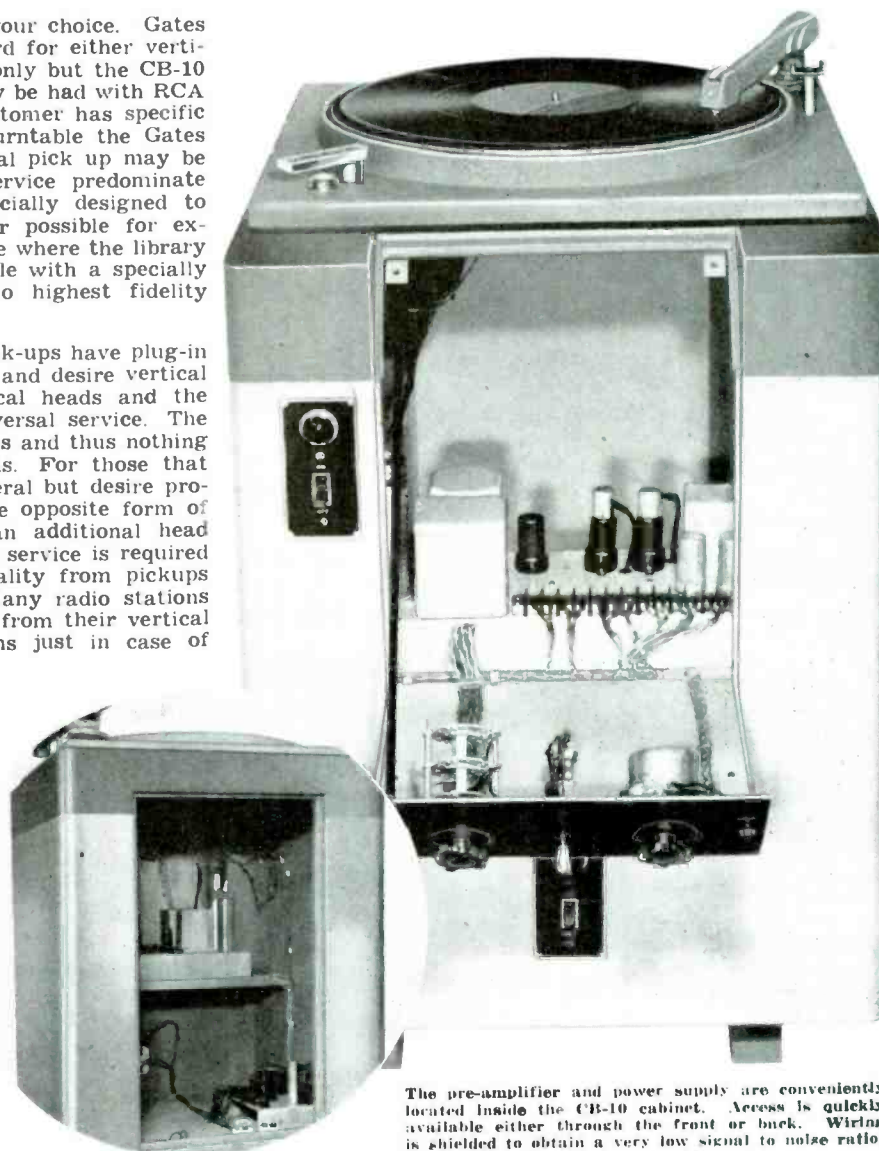

The pre-amplifier and power supply are conveniently located inside the CB-10 cabinet. Access is quickly available either through the front or back. Wiring is shielded to obtain a very low signal to noise ratio.

GATES RADIO COMPANY
 MANUFACTURERS, ENGINEERS, SINCE 1922
 QUINCY, ILLINOIS, U.S.A.

GATES TRANSMITTING EQUIPMENT

ALL OVER THE WORLD

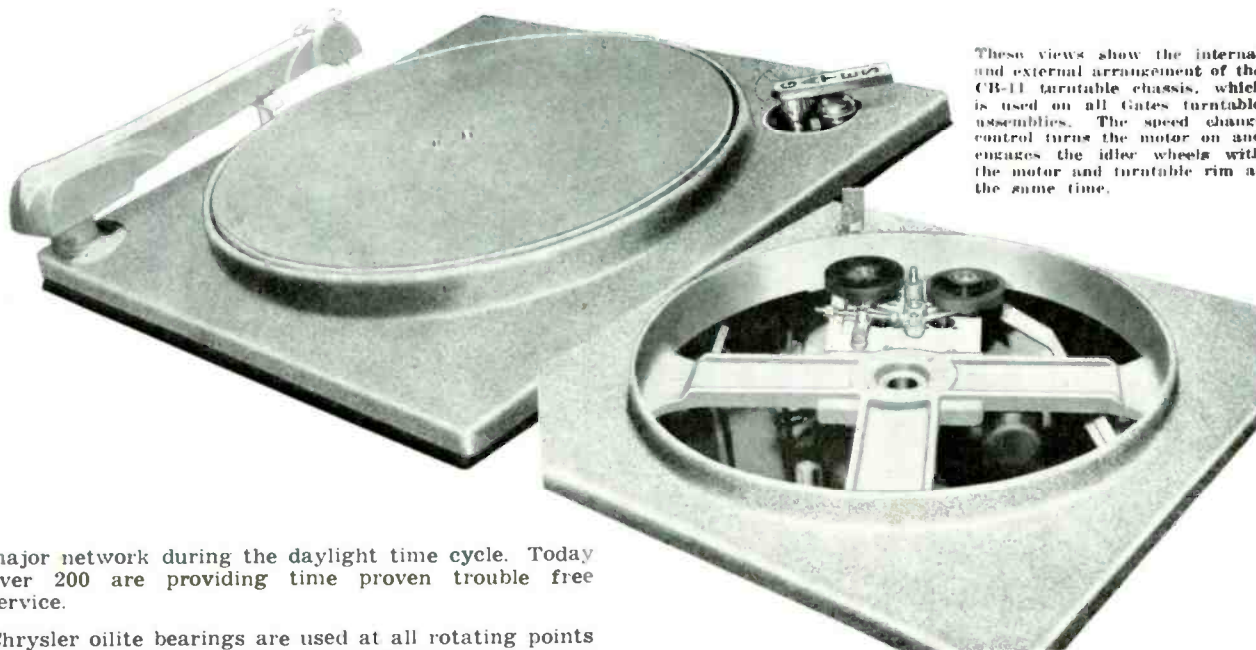

These views show the internal and external arrangement of the CB-11 turntable chassis, which is used on all Gates turntable assemblies. The speed change control turns the motor on and engages the idler wheels with the motor and turntable rim at the same time.

major network during the daylight time cycle. Today over 200 are providing time proven trouble free service.

Chrysler oilite bearings are used at all rotating points. The center spindle bearing is a full inch in diameter meaning no side wobble. Note that the casting while being full sized is ribbed scientifically and provides full rim protection to the platter as well.

The Speed Change is perhaps the outstanding feature of the entire equipment. There are no two handed operations, no planetary drives to change, no noise whatsoever in changing speeds and it may be done instantly. Note on the illustration there is but a single lever. It is normally held at center (off position) by spring tension. Turn in one direction and you have 33 $\frac{1}{3}$ RPM and in the other 78 RPM. The motor turns on in the same operation.

The Pre-Amplifier has three audio stages, the output of which feeds the fader control and "broadcast-cue" switch. The Gates MO-2721 cue amplifier for rack or cabinet mounting may be used for independent cueing or you may use any small loud speaker amplifier for this service. A small power supply is also incorporated to operate the preamplifier so that no external wiring is required. Note that the front door of the cabinet

lets down for complete accessibility of tubes and equipment. Removable back door is also provided. Leveling screws for each of the four base corners are part equipment.

Filter Selections are provided for all commonly used transcription services including orthocoustic, American standard and phonograph records plus two vertical filter positions for full high fidelity and slight roll off of high frequencies. Filter selection is noiseless and does not alter audio level.

General Information. The CB-10 series of master transcription equipments have been designed to offer ultra modern appearance and complete convenience of both operator control and mechanical and electrical servicing. Master power switch is provided near the bottom of the cabinet and turntable switch on the left front side. Switches are noiseless mercury type with indicating pilot lights. All pick-ups have diamond stylus and are properly counterweighted for minimum record wear.

SPECIFICATIONS

SPEED ACCURACY—0.4% over extended periods of time.
PLATTER DIAMETER—17 inches.
OVERALL DIMENSIONS—22" wide, 26" deep and 33" high.
TUBES USED—two 6K7, one 6C5, one 6X5.

OUTPUT IMPEDANCE—250 ohms.
OUTPUT LEVEL—approximately —15 VU.
MOTOR—Synchronous capacitor start, vertical design, noiseless.
COLOR—Tutone gray with dark green felt platter topping.

TYPES AVAILABLE

MODEL CB10—For lateral operation only but with complete filter provisions for vertical or vertical-lateral using plug-in heads. Code ZADSO.
MODEL CB10A—For universal vertical-lateral operation. Code ZADUT.
MODEL CB10B—For vertical operation only but with complete filter provisions for lateral or vertical-lateral using plug in heads. Code ZADVY.
MODEL CB10C—Equipped with RCA type M4875C pick-ups. Code ZAEVY.
MODEL CB10D—Equipped with WE109A or 109B pick-ups. Code ZAEVS.

GATES RADIO COMPANY
MANUFACTURERS, ENGINEERS, SINCE 1922
QUINCY, ILLINOIS, U.S.A.

GATES
TRANSMITTING EQUIPMENT
ALL OVER THE WORLD

MODEL CB-7B TRANSCRIPTION TURNTABLE



This second model in the series of CB-7 turntables combines the well proved CB-7 motor mechanism with a new reproducer assembly containing substantial advantages over contemporary types. Most important of these is the inclusion of preamplification as an integral part of the complete unit.

GATES RADIO COMPANY
MANUFACTURERS, ENGINEERS, SINCE 1922
QUINCY, ILLINOIS, U.S.A.

GATES
TRANSMITTING EQUIPMENT
ALL OVER THE WORLD

The famous CB-7 chassis is used in all CB-7B transcription turntables. Its many users attest to its reliability.

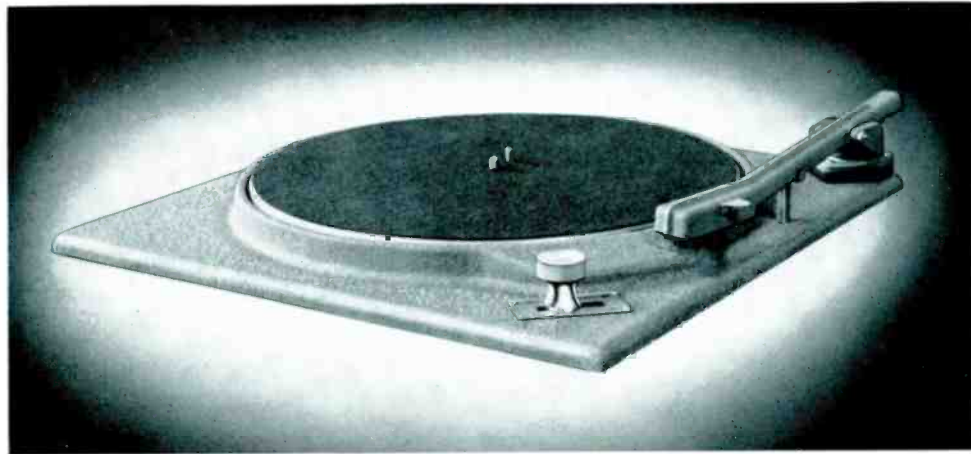

GENERAL INFORMATION

The CB-7B turntable consists of a two speed chassis equipped with a lateral reproducer, MO-2716A or MO-2716B, and is mounted on a cabinet, modern in design, sturdy in construction, and pleasingly finished in grey enamel. Preamplification is supplied by a three stage amplifier mounted inside on the bottom of the cabinet. Five compensation positions to provide proper reproduction of the usual types of present day records and transcriptions are controlled by the switch on the left side. A master power switch, for controlling power both to the turntable and preamplifier, and a switch for turning the power off and on to the turntable only are provided on the right side.

TURNTABLE MECHANISM

An aluminum platter is used, rim driven thru rubber idler wheels. A ground and polished center shaft fitted to the center of the platter runs in a bronze bushing mounted on the aluminum base casting. Oil grooves traverse the length of the bronze bushing to assure proper lubrication. The motor applies power to the rim thru idler wheels of moulded rubber carefully ground to concentricity with their center bushings. These center bushings are made of

Chrysler oilite bearings to provide long life and freedom from excessive maintenance. Speed change is accomplished by loosening the knurled knob on the right front corner slightly and moving it to the right or left as required.

Excellent performance characteristics are prevalent in the CB-7B due to careful selection of materials that are machined and formed to precision tolerances. Speed tolerances on either $33\frac{1}{3}$ or 78 RPM are held to limits far within those generally attributed to the best units. Pleasing cabinet lines will blend into the decorative scheme of any installation.

REPRODUCER ASSEMBLY

The new reproducer, described in detail as the MO-2716 represents a distinct advancement in the design of such apparatus. Two different models are available; MO-2716A equipped with a sapphire stylus and a spare cartridge and MO-2716B equipped with a diamond stylus. The styli are permanently installed in the cartridges and may be exchanged at a reasonable cost by returning damaged cartridges to the factory.

The reed type magnetic cartridge has brilliant tone quality. It may be supplied with either

GATES RADIO COMPANY
MANUFACTURERS, ENGINEERS, SINCE 1922
QUINCY, ILLINOIS, U.S.A.

GATES
TRANSMITTING EQUIPMENT
ALL OVER THE WORLD

diamond or sapphire styli. An aluminum tone arm, carefully balanced on a freely moving mounting has sufficient mass to prevent resonant points.

Different reproduction curves are available by means of the switch located on the left side of the cabinet which selects the proper component arrangement in the preamplifier to give the response curve desired. Five selections are provided for the following types of recordings:

1. Columbia Orthocoustic recordings
2. Orthocoustic transcriptions
3. Standard phonograph recordings
4. Old phonograph recordings
5. Unequalized acetate recordings

These are suggested applications of the five curve selections and although they are correct for obtaining the results expected for present standards of reproduction it is anticipated that individual taste should govern in each installation.

The preamplifier provides an average output level of approximately -20 VU from most recordings which is sufficient for feeding the program or monitoring circuit without further preamplification.

In the rear view below is shown the preamplifier portion of the reproducer assembly. Care is taken in each installation to secure a low signal to noise ratio and excellent quality.

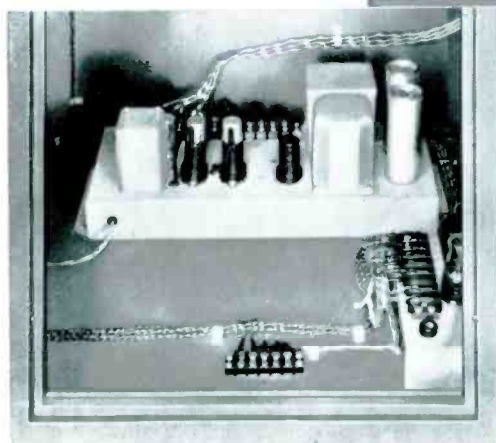

The five position filter control is shown mounted on the left side above.

GATES RADIO COMPANY
MANUFACTURERS, ENGINEERS, SINCE 1922
QUINCY, ILLINOIS, U.S.A.



TRANSMITTING EQUIPMENT

SPECIFICATIONS

SPEED ACCURACY—4% over extended periods of time. Within one revolution accuracy is better than .2%.

TURNTABLE DIAMETER—17 inches.

OVERALL DIMENSIONS—22 inches wide by 22 inches deep by approximately 33 inches high. Packed for export 24 cubic feet.

WEIGHT—Gross, approximately 200 lbs. Net, 155 lbs. Packed for export, 230 lbs.

POWER REQUIREMENTS—Approximately 150 watts from 115 volt, 60 cycle source. Other voltages and frequencies available.

COLOR AND FINISH—Cabinet is flat two-tone grey enamel. Turntable assembly finished in grey wrinkle enamel with green felt topping on platter.

MOTOR SPECIFICATION—1/75 HP, Continuous Duty Type. Very quiet and stable in operation.

The CB-7B is supplied in the following selections:

1. CB-7B complete with MO-2716A lateral reproducer assembly with spare sapphire cartridge. Code YUZRY.
2. CB-7B, same as above, except equipped with MO-2716B reproducer assembly (diamond cartridge), no spare. Code YUZYR.
3. CB-7B, same as No. 1 except less cabinet. Code ZAAHS.
4. CB-7B, same as No. 2 except less cabinet. Code ZAAJT.
5. CB-7, Chassis only. Code YUOWM.

SALES OFFICES

123 Hampshire St.
Quincy, Illinois

1350 North Highland Ave.
Hollywood 28, California

40 Exchange Place
New York 5, N. Y.

Distributors are conveniently located
in other sections of the United States



GATES RADIO COMPANY
MANUFACTURERS, ENGINEERS, SINCE 1922
QUINCY, ILLINOIS, U.S.A.

GATES
TRANSMITTING EQUIPMENT
ALL OVER THE WORLD

TYPE RMC TRANSCRIPTION PICKUP KITS

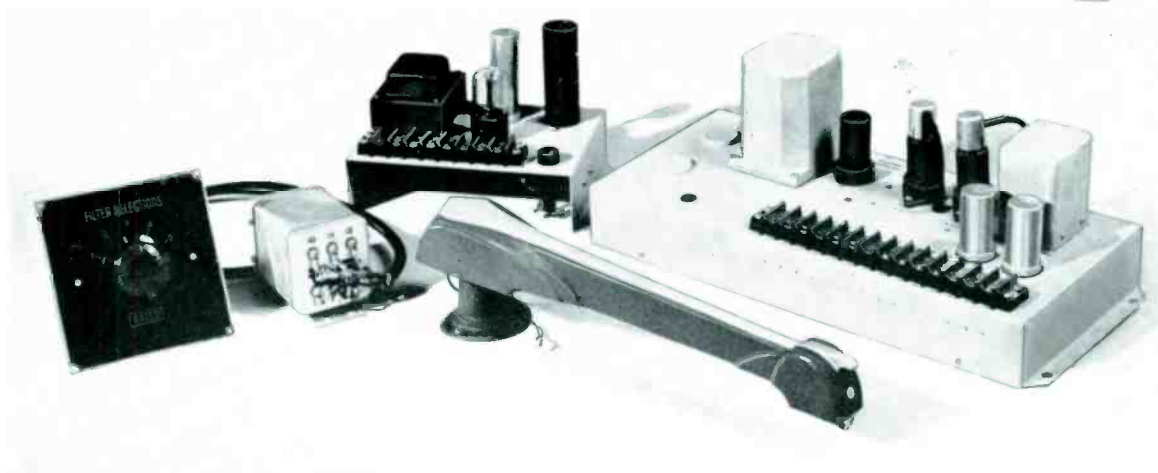

RMC pickup complete with filters, power supply and three stage preamplifier—Selection seven.

The type RMC transcription reproducer is offered in three types and in several kit combinations both with and without preamplifiers so that the broadcaster may have a wide selection to fit his exact needs. Outstanding is the fact that the same equalizer and filter switch assembly is used with any of the three types, namely, lateral only, vertical only, or universal vertical-lateral. Thus with the "plug-in" head feature even though the broadcaster might procure a lateral pickup only he can convert to vertical or universal by simply plugging in a new head.

In the selection of the proper pickup it becomes obvious that the pickup designed for one service, such as lateral only or vertical only, has all of the attention paid to this service in its manufacture. The universal pickup for both vertical and lateral operation is recommended where the library is divided

between both types of transcriptions. Stations having a library predominantly lateral should purchase the lateral pickup and the reverse is true where the library is predominantly vertical. Where emergency service is desired for vertical but the library is lateral a spare vertical head only can be used which may be plugged into the arm quickly.

TECHNICAL DETAIL

Each reproducer is equipped with a carefully ground diamond stylus which may be used at will with either vinylite or shellac pressings. The mass of the moving element is only 22 milligrams and stylus pressure is less than 35 grams. Unit is designed for 16" or smaller records. A 2 mil. radius stylus is employed. Output level for both lateral and universal models is -53 Db. and the vertical model -43 Db. Output will match 50, 250 or 500 ohms.

GATES RADIO COMPANY
MANUFACTURERS, ENGINEERS, SINCE 1922
QUINCY, ILLINOIS, U.S.A.

GATES TRANSMITTING EQUIPMENT ALL OVER THE WORLD

FILTER OR EQUALIZER

Has five positions, two of which are used for vertical and three for lateral. These are (1) vertical high fidelity, (2) vertical with slight high frequency roll off, (3) lateral to NAB recording standards, (4) lateral to orthocoustic recording standards, and (5) high frequency roll off for phonograph records and worn transcriptions. The following kits are offered as standard stock models:

SELECTION ONE—Consists of 1 complete UL2DL pickup with filter switch, dial plate, knob and plug-in type lateral reproducer head and ready to connect to your amplifiers. Order code 219.

SELECTION TWO—Same as selection one only vertical reproducer instead of lateral. Type UL2DV. Order code 220.

SELECTION THREE—Same as selection one only uses universal vertical-lateral reproducer type UL2. Order code 261.

SELECTION FOUR—Consists of selection one plus Gates 61-B preamplifier and MO2708 power supply for complete high level operation. Gates MO-2899. Order code 221.

SELECTION FIVE—Same as selection four only with vertical pickup only. Gates MO-2900. Order code 222.

SELECTION SIX—Same as selection four only with universal vertical-lateral reproducer. Order code 239.

SELECTION SEVEN—Employs UL2DL lateral reproducer with 3 stage preamplifier and power supply, complete with all filters, equalizer and knob ready to use. This type desirable where greater preamplification is desired because of loss in station mixing system, etc. MO-2924. Order code 262.

SELECTION EIGHT—Same as selection seven only with vertical reproducer only. Gates MO-2925. Order code 263.

SELECTION NINE—Same as selection seven only with universal vertical-lateral pickup head. Gates MO-2926. Order code 264.

SPARE HEADS

Are available for all types and are suggested when purchasing turntables to prevent inconvenience in case of breakage. Nominal repair charges and quick service provided on

all replacement and repair orders. Order code 223 for lateral head only. Order code 224 for vertical head only. Order code 244 for universal vertical-lateral head only.

PREAMPLIFIER DETAIL

As two types are outlined herein, holders of Gates catalogs will find full detail on the 61-B two stage preamplifier which employs a 6J7 first stage and a 6C5 second stage with overall gain of 43 Db. The MO-2716 three stage amplifier has an additional stage to provide an overall gain of 60 Db. where requirements demand more gain which is the exception rather than the rule. Two 6K7 and one 6C5 tubes are employed. Both amplifiers are of the chassis type to mount adjacent to the pickup such as in the turntable cabinet.

POWER SUPPLY

A small power supply large enough to power one or two preamplifiers of either type above. Employs a 6X5 tube and heavily filtered supply for low noise operation.

Pickups listed herein are used on all Gates standard turntables and are recommended by us as high quality, well built units, which when given reasonable care will give long high fidelity service.

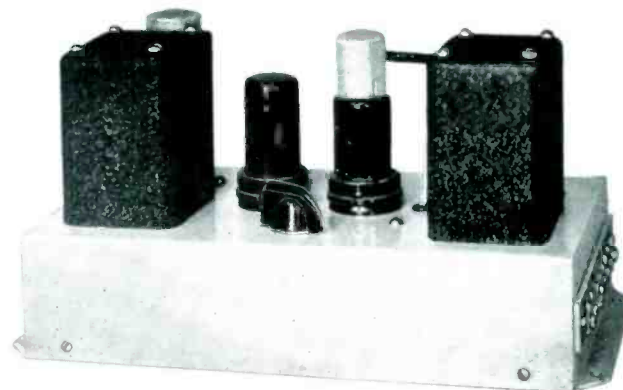

61-B Preamplifier

GATES RADIO COMPANY
MANUFACTURERS, ENGINEERS, SINCE 1922
QUINCY, ILLINOIS, U.S.A.

GATES
TRANSMITTING EQUIPMENT
ALL OVER THE WORLD

MO-2883 CUEING AMPLIFIER

A Rack Mount Amplifier specifically designed
for Turntable Cueing but usable for
many other applications.



An excellent companion unit for the Gates CB-10
Transcription Turntable.

THE MO-2883 Cueing Amplifier is designed for use particularly with the CB-10 Transcription Turntable so that when the cueing switch on this turntable is to "cue" position this small amplifier with its self-contained loudspeaker will provide an oral means of setting up transcriptions for broadcasting.

It is particularly pointed out that the MO-2883 Amplifier is not designed as a high quality reproducing unit and has a relatively narrow audio range so that it will carry over room noise and yet require a very low audio level for audibility to the operator.

GATES RADIO COMPANY
MANUFACTURERS, ENGINEERS, SINCE 1922
QUINCY, ILLINOIS, U.S.A.

TRANSMITTING EQUIPMENT

The amplifier is on an 8 $\frac{3}{4}$ " x 19" rack panel and has a self-contained 5" PM type dynamic speaker. Its front panel complement includes master gain control, starting switch and pilot light. It is finished in Gates gray. The amplifier is a two stage high gain amplifier to produce good loudspeaker volume when bridged across a 250 ohm circuit of negative 30 VU output. It employs a 6K7 pentode first stage and a 6L6G output stage with a 5U4G rectifier. The input is high impedance (approximately 50,000 ohms) so that this amplifier may be bridged across any lower impedance circuit without affecting it in any way. Where it is

necessary that the input circuit be balanced to ground an external input transformer may be purchased for this service. When used with the CB-10 Turntable this transformer is not required.

The use of the MO-2883 Cueing Amplifier is well recognized as highly desirable in modern broadcasting stations as it frees another amplifier that might be a standard unit in the speech equipment for other more important service. Thus, existing stations as well as new stations will be highly interested in the addition of such a unit.

SPECIFICATIONS

INPUT — 50,000 Ohms.
 OUTPUT — To speaker.
 GAIN — 60 Db.
 NOISE — 50 Db. below normal speaker level.
 POWER — 115 volt, 60 cycle, 60 watts.

MO-2883 Cueing Amplifier with one set of tubes. Code word ZAHET.

Model 41922 Input Transformer to match 50, 250 or 500 ohms to above amplifier.
Code word ZAHIV.

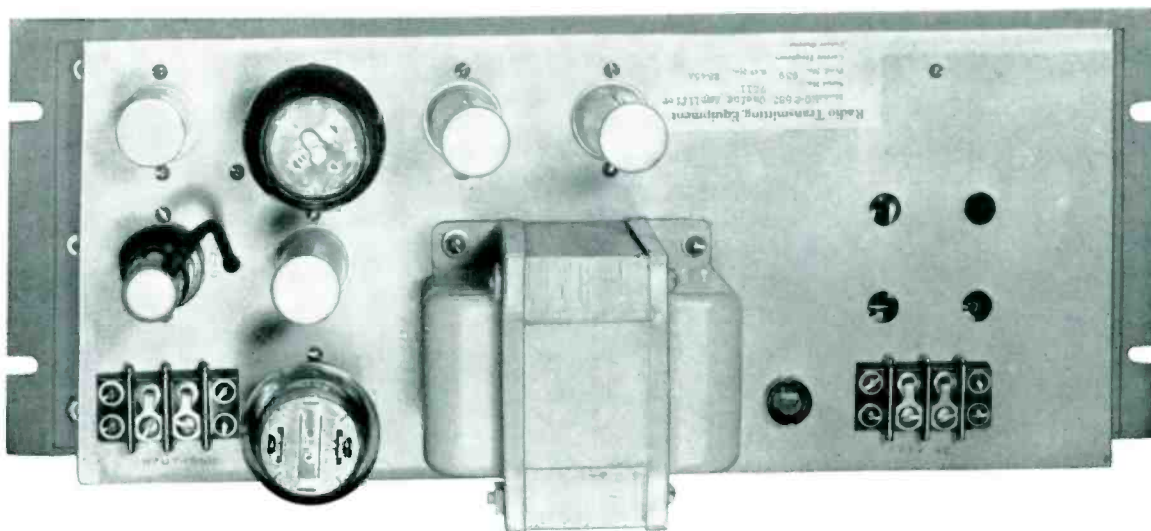

GATES RADIO COMPANY
 MANUFACTURERS, ENGINEERS, SINCE 1922
 QUINCY, ILLINOIS, U.S.A.

GATES
TRANSMITTING EQUIPMENT
ALL OVER THE WORLD

MODEL CB-8R RECORDER



The CB-8R recorder consists of a turntable, overhead feed screw mechanism, cutter head, playback reproducer, microscope and automatic equalizer all mounted into an attractive two tone cabinet of proper height to operate the equipment from a standing position. Either 33 or 78 RPM recordings can be made.

A lead screw is furnished with each overhead mechanism having either inside out or outside in feed and any standard number of lines per inch. The threads are buttressed to assure

positive drive. Spiraling at any point of a recording is easily done by means of the hand crank and special clutch arrangement. Lead screws are quickly interchangeable without the use of any tools.

The cutter head is substantially mounted on a plate that is adjustable up or down by means of a thumb screw to obtain the proper cutting angle and depth of groove. Very accurate settings are easily accomplished. A positive action hand lever lowers or raises the cutter head onto the recording blank.

GATES RADIO COMPANY
MANUFACTURERS, ENGINEERS, SINCE 1922
QUINCY, ILLINOIS, U.S.A.

TRANSMITTING EQUIPMENT

Exceptional fidelity is available from the reed type cutter head even without equalization. However, for the best results, equalization is recommended. The automatic equalizer available with the CB-8R unit is a frequency compensating network designed so that it produces faithful response on the recording in keeping with the amplifier characteristics. It is controlled throughout the travel of the cutter head by a cable attached to a self-retracting pulley which actuates the equalizer.

The turntable mechanism is designed especially for recording. The precision machined steel platter and 1/20 h.p. motor assure very stable operation throughout the varying loads presented during recording of selections having even exceptionally wide dynamic ranges.

Cabinet requirements for recording are very important. Acoustic treatment has been carefully applied wherever necessary to assure reduction of mechanical noises below the point where there could possibly be any effect on the recordings.

SPECIFICATIONS

FREQUENCY RESPONSE: Cutter head 50 to 8000 cycles, Playback 70 to 7500 cycles.

SPEED ACCURACY: Better than .4% over extended periods of time and better than .2% in any single revolution.

NOISE LEVEL: Both mechanical and electrical noise at least 40 decibels below maximum reproduced level.

DISTORTION: Cutter head, less than 3% at 100 cycles, 1% or less above 1000 cycles.

MOTOR: 1-20 h.p. continuous duty type.

POWER REQUIREMENTS: 100 watts from 115 volt, 60 cycle source. Other voltages and frequencies available at slight additional cost.

TIME SCALE: Calibrated in elapsed time for 78 or 33 $\frac{1}{3}$ RPM speeds, either inside out or outside in for 96, 104, 112, or 120 grooves per inch.

DIMENSIONS: 22" x 22" x approximately 49" high. Packed for shipment, approximately 24 cu. ft.

WEIGHT: Net, approximately 180 pounds; Gross, approximately 205 pounds.

FEED PER INCH: 96 or 112 lines per inch inside out or outside in depending on customers' choice.

CB-8R Recorder, complete with overhead feed screw mechanism, high fidelity cutter head, sapphire stylus, automatic equalizer, microscope, dual speed turntable, playback, and cabinet. Code YUTKO.

CB-8R Recorder, same as above but less cabinet. Code YUVAH.

CB-8R recorder complete but without cutter head angular adjustment by thumb screw assembly. Code YUVHA.

CB-8R Recorder, same as above but with standard fidelity cutter head and less automatic equalizer and microscope. Code YUVIK.

CB-8R Recorder, same as above but less cabinet. Code YUVLO.



The CB-8R Recorder complete with accessories comes in this attractive cabinet assembly; a truly modern note in the studio.

GATES RADIO COMPANY
 MANUFACTURERS, ENGINEERS, SINCE 1922
 QUINCY, ILLINOIS, U.S.A.

TYPE 100-R RECORDING RACK

The 100-R Recording Rack consists of the amplifying, equalizing, and control apparatus necessary to produce high quality recordings when used in conjunction with good recording apparatus. Two complete recording channels are available plus an additional channel for monitoring.

Two recording amplifiers, a limiting amplifier, and a monitoring amplifier together with a control panel, equalizer panel and a jack panel are mounted in one relay rack cabinet. A switch and fuse panel and terminal strips are located at the bottom. All incoming and outgoing terminations are made to these terminal strips.

Meters for indicating limiting action and the level out of each recording amplifier are located on the control panel. A separate meter panel containing a 0-100 ma., a 0-10 ma., and a 0-500 volts D.C. meter is connected to each amplifier and permits indication of plate current and plate voltage. Push buttons on the front panel of each amplifier connect these meters to the appropriate circuit as desired. Gain controls for the limiting amplifier, monitoring amplifier and each recording amplifier are also supplied on the control panel.

All of the amplifiers are wired to the jack panel and are normal- ed thru so that the incoming program is first fed thru the limiting amplifier and then to either or both recording amplifiers according to the position of the selector switch on the control panel. The monitoring amplifier may be patched into any of the "listening" jacks. Each line jack and apparatus jack has a "listening" jack above it connected in parallel to that monitoring at every point in the circuit is available.

On the control panel variable attenuators are available for adjusting level to any of the amplifiers. Master gain controls are provided on each recording amplifier and the monitoring amplifier.

Equalization controls for each recording channel adjust the slope accentuation of higher frequencies up to 4,000, 6,000, 8,000, and 10,000 cycles or remove it entirely according to the setting used. When the monitoring amplifier is used for playback pur-

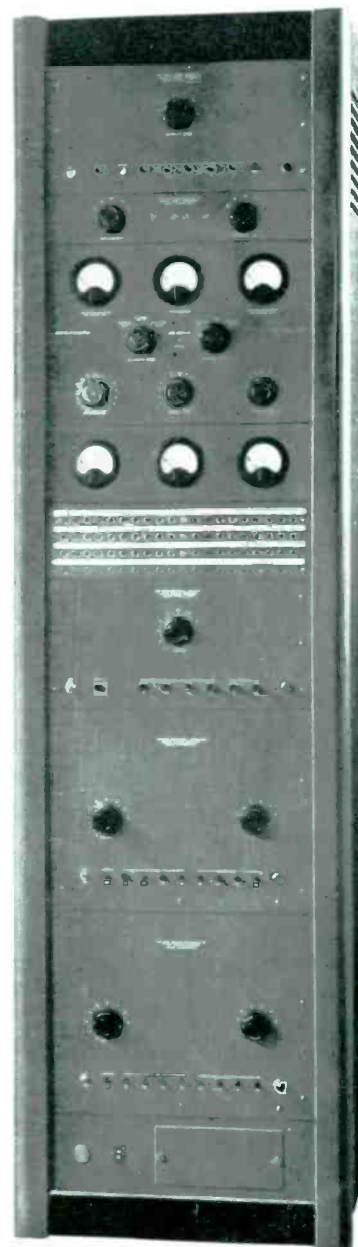

Front View—100R Recording
Rack Assembly

GATES TRANSMITTING EQUIPMENT ALL OVER THE WORLD

poses either of two lines to pickups may be selected and are automatically connected to the input of the monitoring amplifier.

Due to the flexible circuit arrangement in the 100-R rack, any practical recording setup can be easily and quickly made. Examination of the specifications will reveal the exceptional characteristics that are built into each 100-A to assure the best results in making recordings.

SPECIFICATIONS

FREQUENCY RESPONSE: Recording channels flat within 1½ db. from 50 to 10,000 cycles. Monitoring channel, flat within 2 db. from 50 to 8,000 cycles. With equalizer in circuit, frequencies below 4,000, 6,000, 8,000, or 10,000 cycles are attenuated in accordance with setting of control and operation of automatic equalizer to secure proper equalization from outside to inside of the recording.

NOISE LEVEL: Total noise more than 70 decibels below maximum power output level.

INPUT IMPEDANCE: 500 ohms.

OUTPUT IMPEDANCE: 500 ohms.

POWER OUTPUT: 50 watts maximum.

DISTORTION: Less than 2% at full output.

TUBE COMPLEMENT: Limiting Amplifier, two 6L7, three 6SJ7, two 6J5, one 6H6, one 6x5, one 2A3, one 5Z3; Monitoring Amplifier, two 6J7, two 6SJ7, two 6L6, one 5Z3; Each Recording Amplifier, one 6SF5, one 6J7, one 6F8G, four 807, two 83.

CONTROL: Switches are located on the front of the control panel for setting high frequency equalization point and selection of either or both recording channels. A switch is also available for connecting the monitoring amplifier input to either of two playback pickups or an incoming line. Variable pads are furnished for varying the input to each recording amplifier, the limiting amplifier and the monitoring amplifier.

METERS: VU meter for indicating output of each recording amplifier, Limiter action meter, 0-100 ma., 0-10 ma., 0-500 volts D.C. for indicating circuit conditions in each amplifier.

POWER REQUIREMENTS: Available for operation from 115 or 230 volt, 50-60 cycle source. Other frequencies may be had on order. Total drain approximately 550 watts.

100-R Recording amplifier rack for operation on 115 volts, 50-60 cycles.
Code YUWIL.

100-R recording amplifier rack for operation on 230 volts, 50-60 cycles
Code YUWYP.

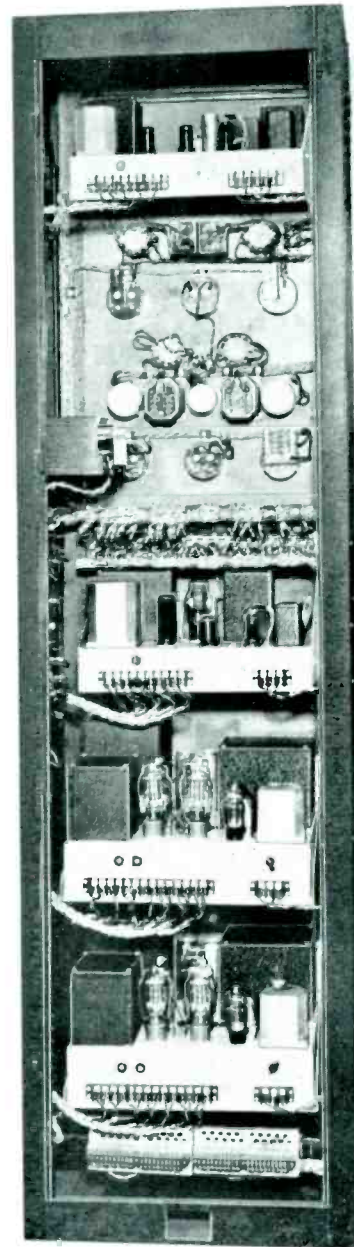

Rear View—100R Recording
Rack Assembly

GATES RADIO COMPANY
MANUFACTURERS, ENGINEERS, SINCE 1922
QUINCY, ILLINOIS, U.S.A.

GATES
TRANSMITTING EQUIPMENT
ALL OVER THE WORLD

MODEL RA-10
RECORDING AMPLIFIER

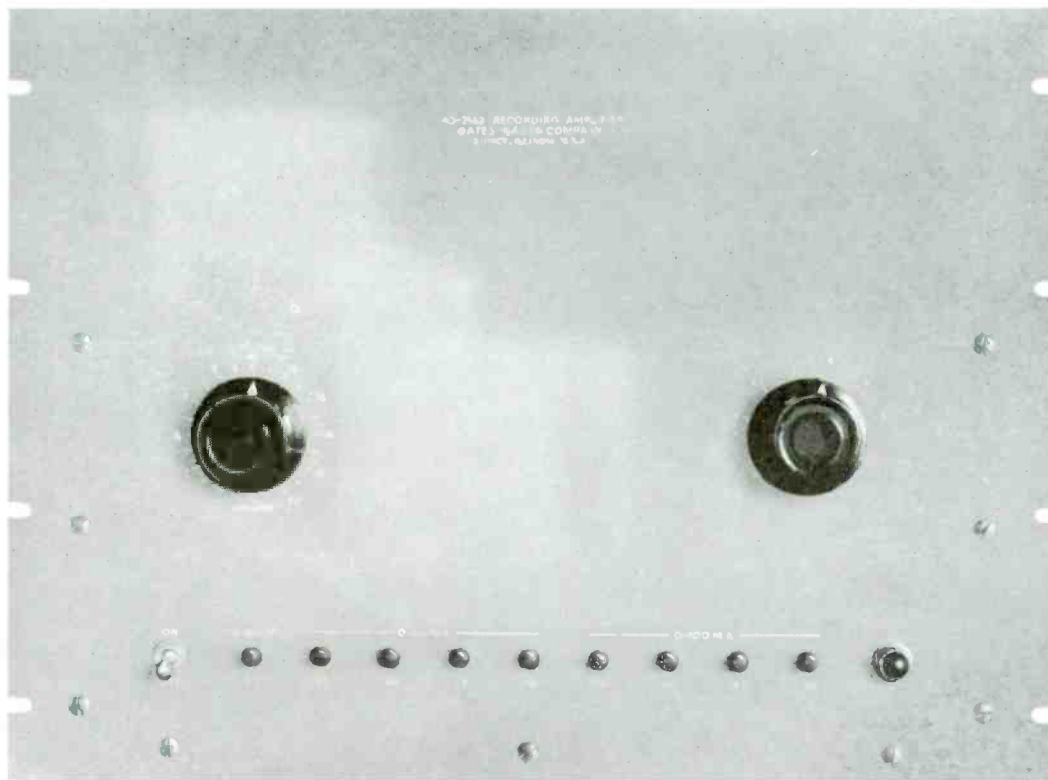

The Model RA-10 Amplifier is designed to produce frequency response curves for making recordings having orthacoustic, standard lateral or straight line fidelity characteristics. A three position switch on the front panel makes any one of the three characteristics available by selecting the proper filter circuit within the amplifier.

Basically, the RA-10 Amplifier is a four stage unit having exceptional frequency response, high gain and at least fifty watts output. The input circuit is arranged for matching a 500 ohm line or bridging a line for simultaneous recording and broadcasting or similar arrangements. The output transformer has terminations for feeding a 500, 250, or 15, or 6 ohm

GATES RADIO COMPANY
MANUFACTURERS, ENGINEERS, SINCE 1922
QUINCY, ILLINOIS, U.S.A.

TRANSMITTING EQUIPMENT

line as the case may be. Both input and output circuits terminate on strips on the rear of the amplifier. The entire assembly mounts on a panel and shelf assembly designed for installation in any standard 19" relay rack type of cabinet. Facilities have been provided on the front panel for quickly metering the plate current in each amplifying tube and the DC voltage from the rectifier filter by means of push buttons and external meter panel, MO-2641, available as extra equipment. All functional designations are clearly marked adjacent to each control and are very legible against the attractive gray background of the front panel.

Inclusion of the RA-10 Amplifier in any recording installation will greatly improve the results obtained especially if the orthacoustic curve is used and proper facilities are incorporated in the playback system. Your inquiry for information on complete systems including all the desirable features will be promptly handled.

SPECIFICATIONS

FREQUENCY RESPONSE:

- Position 1: \pm or $-1/2$ db. from 20 to 10,000 cycles.
- Position 2: Orthacoustic recording curve.
- Position 3: Standard lateral recording curve.

INPUT IMPEDANCE: 500 ohms and 20,000 ohms for bridging.

OUTPUT IMPEDANCE: 500, 250 or 15 or 6 ohms as requested by customer.

GAIN: Input, 500 ohms, 71 db. Input, 20,000 ohms bridging 500 ohm line, 50 db.

POWER OUTPUT: 50 watts.

DISTORTION: Less than $1\frac{1}{2}\%$ at full output.

NOISE LEVEL: Better than minus 40 db.

CONTROL FACILITIES: On-off toggle switch, gain control, curve selection switch, red "power on" bulls eye, metering push buttons for plate currents and high voltage.

POWER SUPPLY: Built in, using two type 83 tubes full wave.

AMPLIFIER TUBES: One 6SF5, one 6J7, one 6F8G, four 807.

POWER REQUIREMENTS: Approximately 200 watts from 115 to 230 volt, 60 cycle source.

FINISH: Gray enamel.

DIMENSIONS: Requires 14 inches of standard rack height, 19 inches wide, 16 inches deep.

SHIPPING WEIGHTS AND DIMENSIONS: One case measuring approximately 32"x19"x18" (6.5 cu. ft.), weighing approximately 100 pounds net, 145 pounds gross.

Type RA-10 Recording Amplifier with one set of tubes. Code word YUTGA.

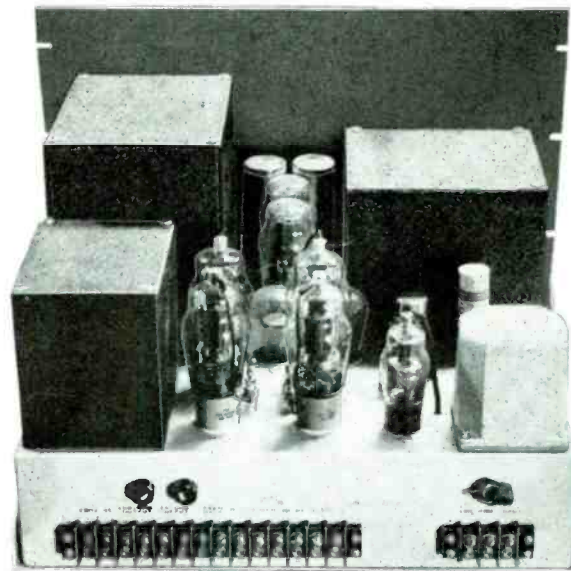

Rear View, Model RA-10 Amplifier

GATES RADIO COMPANY
 MANUFACTURERS, ENGINEERS, SINCE 1922
 QUINCY, ILLINOIS, U.S.A.

GATES
TRANSMITTING EQUIPMENT
ALL OVER THE WORLD

REMOTE FOURSOME

Model GR-9091

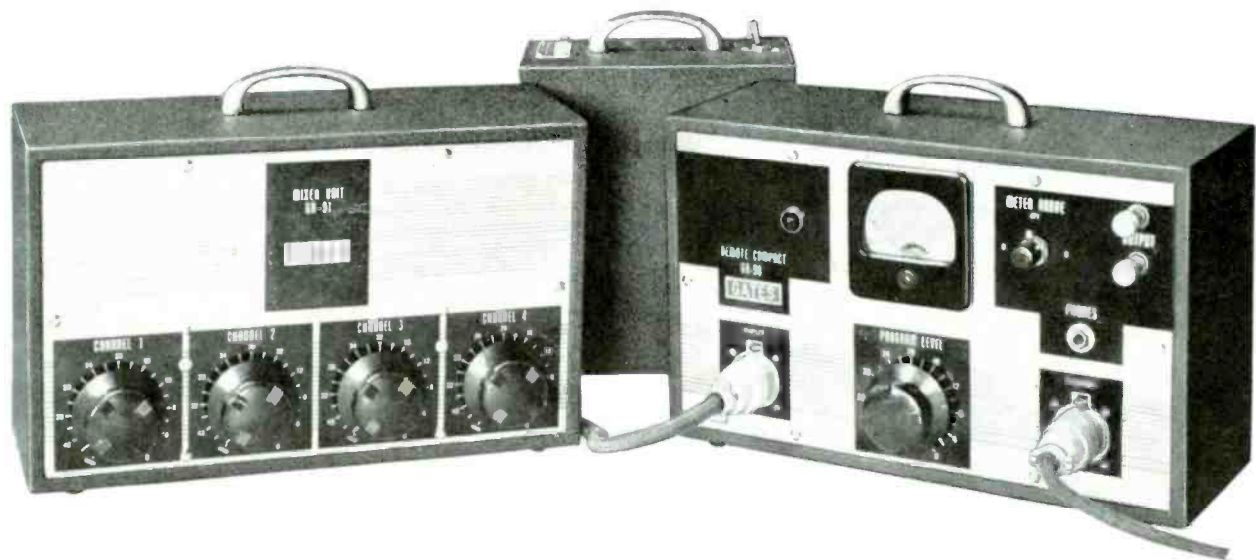

Here is a truly versatile remote unit that has facilities for the largest or smallest jobs. Convenience is emphasized by providing a practical mechanical arrangement both in the different units and the attractive carrying case. Quality is assured by the inclusion of high grade components, good engineering and careful testing of each unit.

GATES RADIO COMPANY
MANUFACTURERS, ENGINEERS, SINCE 1922
QUINCY, ILLINOIS, U.S.A.

GATES
TRANSMITTING EQUIPMENT
 ALL OVER THE WORLD

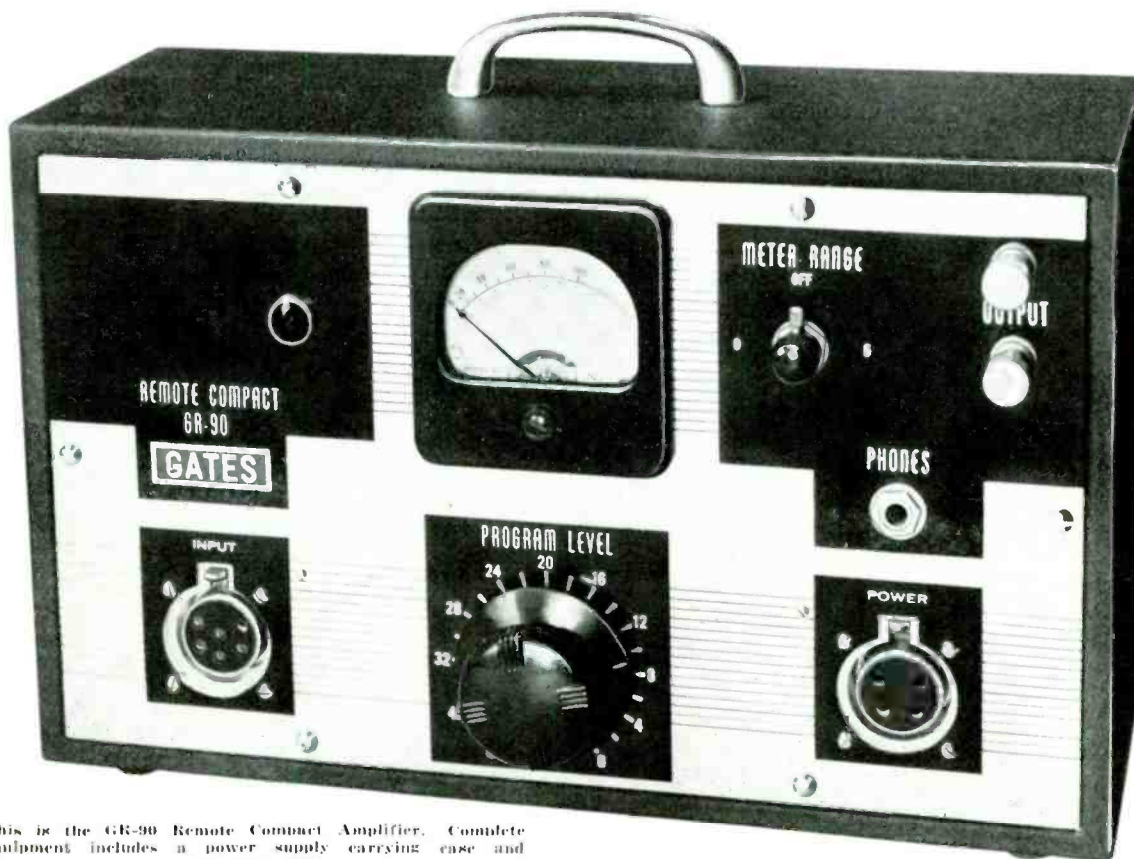

This is the GR-90 Remote Compact Amplifier. Complete equipment includes a power supply carrying case and connector cable.

The GR 9091 Remote Foursome is a modern remote amplifier combination consisting of the GR-90 Remote Compact amplifier and the GR-91 mixer. Voltages for these two units are derived from a separate power supply which operates from a 115 volt, 60 cycle A.C. source. All are easily carried in one attractive aeroplane luggage type carrying case.

GR-90 Amplifier

This unit is a new and improved version of the Remote Compact amplifier; long a familiar member of the Gates line of remotes. Four amplifying stages are employed to secure the necessary gain to obtain ample output level

when using any type of microphones. High fidelity and low distortion and noise are also inherent in this equipment.

On the front panel are located the gain control, VU meter, output terminals and a combination six prong Cannon receptacle for taking either a standard three prong Cannon microphone connector or the six prong connector on the interconnecting cable to the GR-91 mixer. A jack is provided for headphone monitoring and a meter range switch changes the maximum scale reading of the VU meter to plus 3 VU or plus 8 VU. A third position marked "off" removes the VU meter from the circuit.

The GR-90 Remote Compact amplifier is avail-

GATES RADIO COMPANY
 MANUFACTURERS, ENGINEERS, SINCE 1922
 QUINCY, ILLINOIS, U.S.A.

GATES
TRANSMITTING EQUIPMENT
ALL OVER THE WORLD

able without the GR-91 mixer and when so supplied comes complete with the power supply and a carrying case the same as that furnished with the complete Remote Foursome except smaller. A separate battery carrying case which matches the unit carrying case can be supplied if desired.

GR-91 Mixer and Preampfier

This section of the Remote Foursome is a four channel mixer and two stage preampfier designed to connect to the GR-90 Remote Com-

pack thus providing for the use of four microphones. The two stages of preamplification add sufficient gain to the equipment to permit the use of microphones having extremely low output level.

Power for the GR-91 is derived thru the interconnecting cable which connects to the six prong receptacle on the front of the GR-90 Compact. The audio signal is also carried in this same cable. Microphone receptacles of the standard Cannon type are mounted on the rear of the unit.

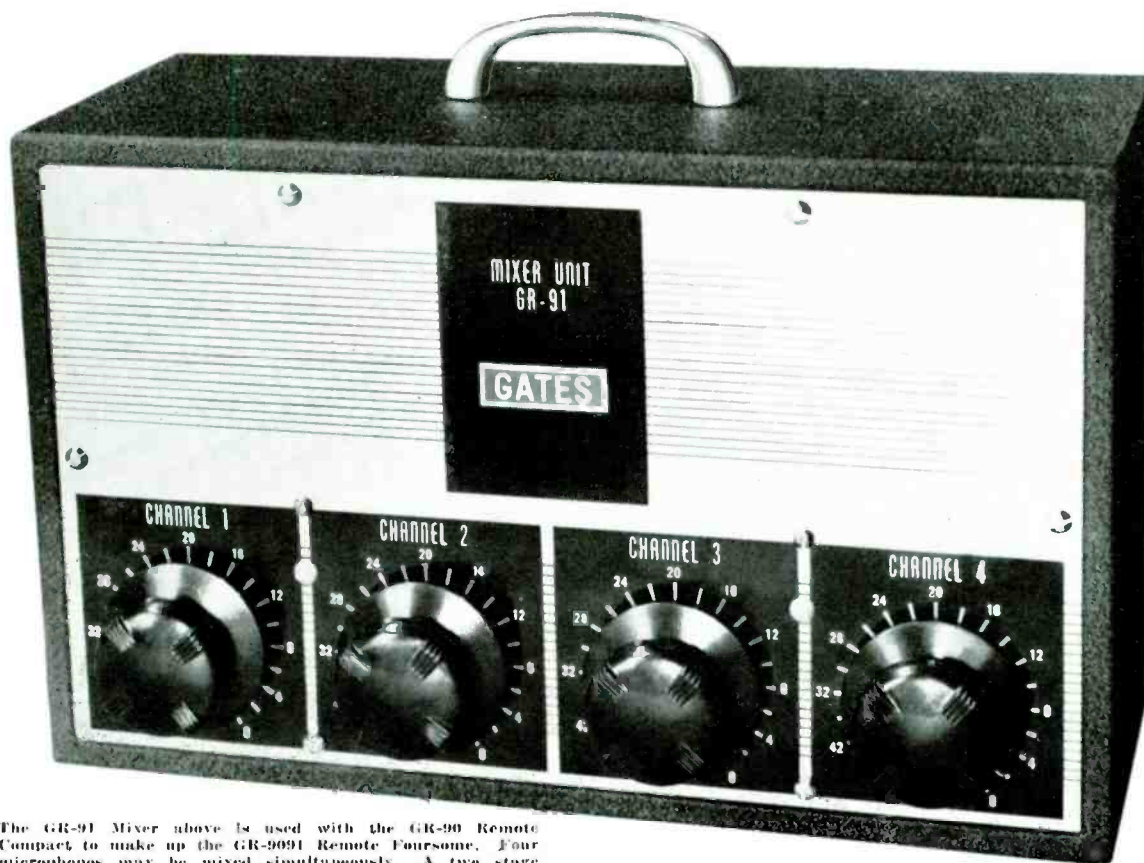

The GR-91 Mixer above is used with the GR-90 Remote Compact to make up the GR-9091 Remote Foursome. Four microphones may be mixed simultaneously. A two stage preampfier is included whose output is fed thru a connector cable to the input socket on the GR-90 Compact. Power for the preampfier is carried in the same cable.

GATES RADIO COMPANY
MANUFACTURERS, ENGINEERS, SINCE 1922
QUINCY, ILLINOIS, U.S.A.

TRANSMITTING EQUIPMENT

SPECIFICATIONS — GR-9091 Remote Foursome

TUBE COMPLEMENT—two type 6F5 (GR-91 Mixer)
 one type 6F5
 one type 6C5 } (GR-90 Amplifier)
 one type 6F6
 one type 6X5G (Power Supply)

GAIN—110 db.
FREQUENCY RESPONSE—30 - 12,000 cps. + or - 2db.
DISTORTION—1% RMS at + 8VU output.
NOISE LEVEL—58 db. down at an output level of + 8 VU.
INPUT CHANNELS—Four.
INPUT IMPEDANCE—30 or 250 ohms, purchasers choice. All channels same impedance.
OUTPUT IMPEDANCE—600 ohms.
VU METER RANGE—20 to + 8 VU in two ranges.
POWER REQUIREMENTS—90 VA from 115 volt 50/60 cycle power source. Other voltages and frequencies available on order.
DIMENSIONS—GR-90 and GR-91 each 6" deep, 8 $\frac{3}{4}$ " high, 12 $\frac{3}{4}$ " wide. Power Supply, 4" wide, 7 $\frac{1}{4}$ " long, 9" high. Carrying case—Remote Foursome, 13 $\frac{1}{2}$ " wide, 10 $\frac{1}{2}$ " high, 18 $\frac{1}{4}$ " long. GR-90 Remote Compact only, 11 $\frac{1}{2}$ " wide, 13 $\frac{3}{4}$ " long, 10 $\frac{1}{2}$ " high.
WEIGHT—GR-90 only in carrying case—net 28 lbs., gross for domestic shipment 37 lbs., export shipment, 45 lbs. Remote Foursome in carrying case—net 35 lbs., gross for domestic shipment 40 lbs., export shipment 56 lbs.

The following electrical specifications refer to the GR-90 Remote Compact amplifier when used without the GR-91 mixer.

GAIN—76 db.
FREQUENCY RESPONSE—+ or - 1 $\frac{1}{2}$ db. from 30 to 15,000 cycles.
DISTORTION—1% RMS at + 8 VU output.
NOISE LEVEL—60 db. down at + 8 VU output.
INPUT CHANNELS—One.
INPUT IMPEDANCE—30 or 250 ohms, purchasers choice when ordering (may be changed in field if necessary.)
POWER REQUIREMENTS—60 VA from 115 volt 50/60 cycle A.C. source.
OUTPUT IMPEDANCE—600 ohms.



Rear view of the GR-91 Mixer preamplifier unit. All microphone and power connections are made by Cannon connectors which are supplied.

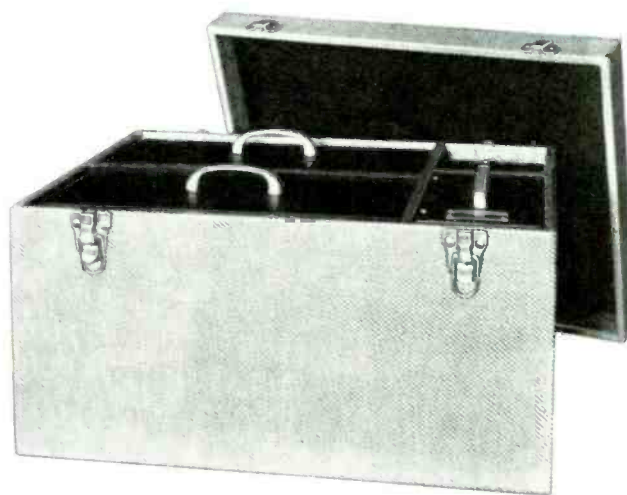

The complete Remote Foursome is shown above in its carrying case. The GR-90 also comes with the same type case except somewhat smaller.

GATES RADIO COMPANY
 MANUFACTURERS, ENGINEERS, SINCE 1922
 QUINCY, ILLINOIS, U.S.A.

THE DYNAMOTE REMOTE AMPLIFIER



For several years this line of remote broadcasting equipment has merited the unqualified acceptance of broadcasters all over the world. The most important and versatile item in this line is the Dynamote Amplifier — the most popular remote amplifier in use. This widespread acceptance has been achieved by using high quality materials incorporated into a design that is sound and practical. Modern styling gives the Dynamote the distinctive appearance so necessary to provide “showmanship” — an important factor in any broadcasting function.

GATES
TRANSMITTING EQUIPMENT
ALL OVER THE WORLD

Construction. Compactness is the keynote in the construction of the Dynamote. The amplifier measures 14½ inches long, 7 inches high and 8 inches deep. It is a four stage high gain unit containing the mixing system, VU meter and all the other circuits associated with the amplifying circuit. Microphone connectors, output terminations and the power supply socket are easily accessible when the unit is out of the carrying case.

Standard equipment for supplying the plate and filament voltages is a power supply measuring 8 by 7 by 4 inches. It receives power from any 115 volt 60 cycle source through a four foot cord and is connected to the amplifier unit by means of a three foot joiner cable. Batteries may be substituted for the

power supply whenever necessary because of the absence of a suitable AC power source.

Front panel design of the amplifier unit has received particular attention to make it adaptable to any operating condition. The designations adjacent to each control are etched on aluminum creating a white on black combination that aids visibility. The entire panel is impervious to wear and will maintain its appearance throughout the life of the equipment.

Both the amplifier and power supply fit into an attractive aeroplane type carrying case that is weather resistant and sturdily constructed to withstand the hard usage that equipment of this type generally receives. A false bottom is provided to make room for the joiner cable and extra equipment always needed on remote jobs such as headphones and a microphone.

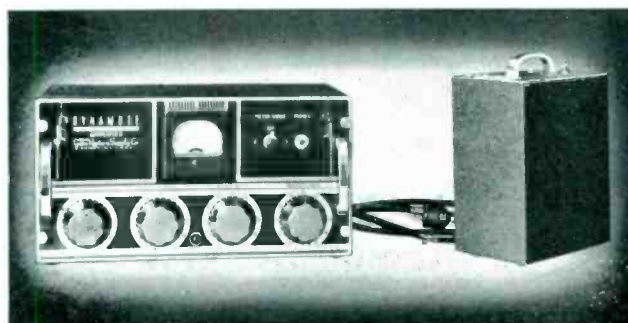

Front view of Dynamote showing power supply and connecting cable

GATES RADIO COMPANY
MANUFACTURERS, ENGINEERS, SINCE 1922
QUINCY, ILLINOIS, U.S.A.

GATES
TRANSMITTING EQUIPMENT
ALL OVER THE WORLD

Mixing Circuit. Three input circuits are provided each being controlled by a separate attenuator so that three microphones may be mixed simultaneously. Each attenuator is a ladder type unit having wiping contacts, low insertion loss and an extremely low noise level. Input impedance may be either 30-50 or 200-250 ohms according to the microphones that are to be used and will be connected as specified on the order. Heavy duty Cannon connectors are provided for each input circuit.

Amplifier. One each 6J7 and 6N7 and two 6C5 tubes are used in the amplifier section. Gain from this tube combination is unusually high

and the noise level is low. Output is brought to a terminal strip on the back and also to a headphone jack and the VU meter.

VU Meter. A standard VU meter, scale B, with a range switch is normally supplied with the dynamote. The normal readings are from minus 20 to plus 3 but can be increased by means of the range switch by 5 VU.

Power Supply. An indirect heater type tube is used as the rectifier in a conventional full wave circuit. The design is very conservative throughout so that dependable operation is assured even on long schedules.

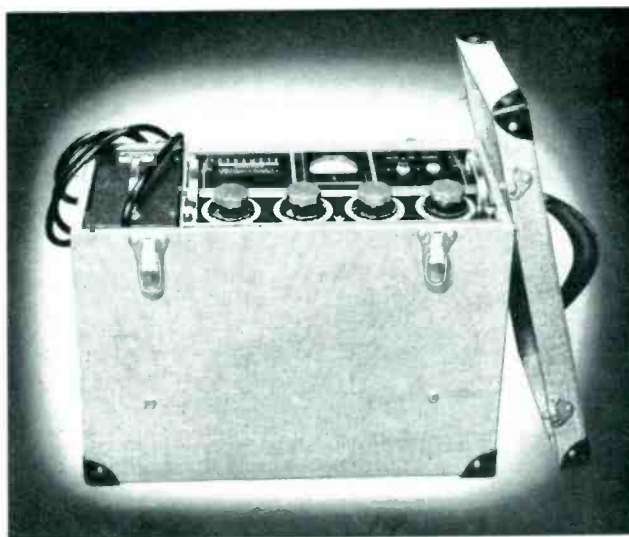

Dynamote and power supply in carrying case

GATES RADIO COMPANY
MANUFACTURERS, ENGINEERS, SINCE 1922
QUINCY, ILLINOIS, U.S.A.



TRANSMITTING EQUIPMENT

TECHNICAL SPECIFICATIONS

A.C. Operation

Tubes: One each 6J7, 6N7, 6X5, two 6C5.

Frequency Response: Flat within one decibel from 50 to 12,000 cycles.

Distortion: Less than 1% at plus 6 VU.

Overall Gain: From input of mixer to output terminals 93 Db.

Noise Level: 50 Db. below normal program level using standard AC power supply.

Input Impedance: Either 30-50 or 200-250 ohms. (Specify which when ordering.)

Output Impedance: 600 ohms.

Maximum Available Power Output: Plus 14 VU at 1.6% distortion.

Power Consumption: 35 watts from 115 volt 60 cycle power line.

Gross Weight: 37 pounds.

Packed Dimensions: Approximately 20 inches long, 8 inches wide, 12 inches high.

Battery Operation

The conditions above noted for A.C. operation are the same for battery operation with the exception of gain. The following information is merely given as an aid to the selection of suitable types of batteries. A carrying case for batteries that matches the Dynamote carrying case in appearance is available for a nominal charge.

Plate Current Drain: 22 ma. at 180 volts average.

Recommended Plate Voltage: 180.

Filament Voltage: 6.

Filament Drain: 1.7 amperes.

Overall Gain: 86 Db.

Dynamote complete with power supply, carrying case, connecting cable and tubes
Code—YURIG



GATES RADIO COMPANY
MANUFACTURERS, ENGINEERS, SINCE 1922
QUINCY, ILLINOIS, U.S.A.

GATES
TRANSMITTING EQUIPMENT
ALL OVER THE WORLD

REMOTE CONDITIONER

Model 6S

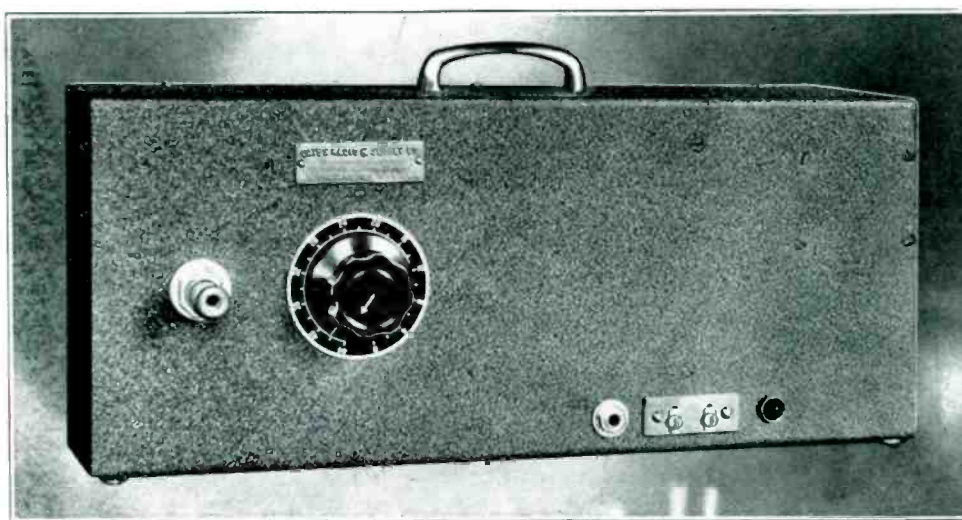

Since its introduction the steadily increasing list of users of the Remote Conditioner attest to its usefulness and reliability for single microphone remote applications. The use of modern components and manufacturing technique assure the quality that commands continuing leadership in this type of equipment.

GATES RADIO COMPANY
MANUFACTURERS, ENGINEERS, SINCE 1922
QUINCY, ILLINOIS, U.S.A.

GATES TRANSMITTING EQUIPMENT ALL OVER THE WORLD

Structurally the Remote Conditioner is a three stage amplifier complete with power supply housed in one cabinet. This in itself is an accomplishment in high quality audio amplifier design. Of course, the technical refinements in the Conditioner were not obtained without diligent research and experimentation. The power supply, for instance, is of the full wave transformer type. No voltage doubler or AC-DC power supplies are used. Additional improvement is obtained by careful placement of the audio transformers and chokes with respect to the power transformer so that the net result is hum reduction to a guaranteed low level of minus 55 Db. below program level.

Operating the Remote Conditioner is exceptionally easy. The only controls are the on-off switch and the gain control. Provision is made for connecting the telephone line to a two terminal strip on the front. The headphone jack is on one side of this strip and a jeweled power supply pilot light is on the other. Microphone connections are made through a Cannon connector supplied with each unit.

Microphones of any standard impedance are accommodated by the Remote Conditioner. The input transformer is normally connected for 200-250 ohms but 30-50 or 500-600 ohm operation is available by changing a few simple connections.

TECHNICAL SPECIFICATIONS

TUBES: One each 6F5, 6C5, 6F6, 6X5.
GAIN: 90 Db.
NOISE LEVEL: 55 Db. below program level of plus 5 VU.
POWER CONSUMPTION: 50 watts from 115 volts 60 cycle AC line.
INPUT IMPEDANCE: 30-50, 200-250, 500-600 ohms. (Specify when ordering.)
OUTPUT IMPEDANCE: 500-600 ohms.
FREQUENCY RESPONSE: Flat within plus or minus 1½ Db. from 30 to 10,000 cycles.
DISTORTION: Less than 1% at plus 10 VU.
DIMENSIONS: 17 inches long, 7 inches high, 4 inches deep.

6S Remote Conditioner complete with tubes. Code—YUZEM



GATES RADIO COMPANY
MANUFACTURERS, ENGINEERS, SINCE 1922
QUINCY, ILLINOIS, U.S.A.

CROSS INDEX AS TO CODE NUMBERS

Instructions: Use this sheet to find proper code number for items of interest. then refer to following code sheet for prices.

	CODE NOS.
REMOTE AMPLIFIERS	
Dynamote Three-Channel Remote Equipment	1 thru 5; 24 and 36
Remote Conditioner	6 and 25
GR-9091 Remote Foursome	8, 10, 27, 37, 38
GR-91 Mixer Units	11, 12, 39, 40, 42, 44
GR-90 Single-Channel Remote Compact	7, 9, 13, 26
Battery Cases	5, 14
Carrying Cases	9, 10, 46

TRANSMITTERS AM	
Model 250C-1 for 250 watts	52, 53, 54, 55, 56, 58, 59, 64
Model BC-250D Deluxe 250 watt	60, 61, 62, 63
Model BC-250D Deluxe 250 watts	67 thru 73
Model BC-5A Transmitter — 5000 watts	83, 84, 85
Model BC-10A Transmitter — 10,000 watts	88, 89, 90
Model HF-1X Code Transmitter — 1000 watts	94, 95
Model HF1-2 High Frequency—1000 watts Broadcast Transmitter	96, 97
Model HF-8 High Frequency Broadcast Transmitter 8000 watts	102, 103, 104
Model MO-2535 Communications Transmitter	110, 111

TRANSMITTERS FM	
Model BF-250A for 250 watts	141
Model BF-1A for 1000 watts	142
Model BF-3A for 3000 watts	143
Model BF-10A for 10,000 watts	144

ANTENNA COUPLING EQUIPMENT	
Model 21-A Tuning Unit — 250 watts	113
Model 21B Tuning Unit — 1000 watts	114
Model 21-C Tuning Unit — 250 watts	115
Model 21-D Tuning Unit — 1000 watts	116
Model 46-A Tower Coupling Unit	117, 118, 119

TOWER CHOKES	
Model 23-A Two-Section Choke	121
Model 23-B Three-Section Choke	122

ANTENNA METERS	
Thermocouple Type Remote Meter Kits	126, 127, 366, 367, 368
Diode Type Remote Meter Kits	128 thru 133
Thermocouple Type Meters only	359, thru 364
Panels for Remote Meters	136, 137

TRANSMISSION LINE EQUIPMENT	
Open Wire Line Equipment	138, 139, 140
Coaxial Line	352 thru 358

MODULATION MONITOR	
Model MO-2639 Modulation Monitor	134

SPEECH EQUIPMENT	
Model 5M Dual Rack Speech System	149, 150
31-B Console, complete	151 thru 154
Studioette	156 thru 158
CB-4 Desk Combinations	159 thru 168
Limiting Amplifiers	171, 172
6-C Amplifier (line and all-purpose)	175, 176
Monitoring Amplifiers	177 thru 180
Line Amplifiers	181, 182
Cueing Amplifier	183
Preamplifiers	185 thru 189
Power Supplies	153, 190, 191, 192, 193
Volume Indicators	194 thru 197
Meter Panels	198
Patch Panels and Cords	201 thru 209 and 211 thru 216
Repeater Transformers	217
Bridging Transformer	218

GATES RADIO COMPANY, QUINCY, ILLINOIS, U. S. A.

CROSS INDEX AS TO CODE NUMBERS

RACK CABINETS	CODE NOS.
All types and sizes — Rack Cabinets	313 thru 319

TRANSCRIPTION TURNTABLES	
CB-11 Chassis only	226
CB-11 Chassis in Cabinet, no pickups	227
CB-7 Turntables, complete	228 thru 233 and 312
CB-10 Turntables, complete	234 thru 236
CB-4 Desk for Turntables	159, 160
CB-4 Desk Combinations	161 thru 168

PICKUP KITS	
Lateral type	237, 244, 245, 262
Vertical type	238, 263
Universal Vertical-Lateral type	239, 240, 244, 246, 261, 264

RECORDING EQUIPMENT	
CB-12 Recording Chassis	247
CB-12 Recorder in Cabinet	248
CB-8R Complete Recorder	249
Recording Heads	250, 251
Feed Screws	252 thru 257
Overhead Mechanisms, complete	258
Recording Amplifiers	175, 177, 179, 259
Complete Recording Racks	260

MICROPHONES AND STANDS	
RCA Microphones	30, 31, 32, 47, 286, 287, 288
W. E. Microphones	33, 34, 289, 290
Shure Microphones	29, 284, 291
Amperite Microphones	285
Boom Stands	278, 282, 283, 292
Floor Stands	279, 280
Desk Stands	281

MICROPHONE CONNECTORS AND CABLE	
Cannon Connectors	267 thru 274
Hubbel Connectors	275, 276, 277
Microphone Cable	17, 18, 266
Two-Conductor Shielded Wire	265

LOUD SPEAKERS	
Jensen and Cinaudagraph Speakers	296 thru 303

MISCELLANEOUS	
Attenuators, variable	323 thru 335
Attenuators, fixed	338 thru 345
Blank Panels	351
Crystals and Ovens	59, 73, 98, 99, 100, 105, 106, 107
Idler Wheels for Turntables	241, 242, 243
Terminal Block	320
Dial Plates and Knobs	348, 349

CODE SHEET FOR ORDER ENTRY AND INTEROFFICE COMMUNICATIONS

Code No.	FULL DESCRIPTION	PRICE
1	Dynamote amplifier for 30 ohm microphones	\$ 255.00
2	Dynamote amplifier for 250 ohm microphones	255.00
3	Dynamote amplifier for 30 ohm microphones but less carrying case	237.00
4	Dynamote amplifier for 250 ohm microphones but less carrying case	237.00
5	Battery case less batteries for all types remote equipment	21.00
6	Remote conditioner Model 6S	88.00
7	Model GR90 Remote Compact	177.50
8	Model GR9091 remote foursome, impedance not stated	325.00
9	Carrying case only for GR90 remote compact	22.50
10	Carrying case only for GR9091 remote foursome	29.50
11	GR91 four channel mixer unit only less carrying case but with joiner cable, impedance to be stated	122.50
12	GR91 four channel mixer with carrying case for carrying GR9091 unit with joiner cable, impedance to be stated	152.00
13	GR90 remote compact but in carrying case for housing GR9091 equipment so that 4 channel mixer may be added later without buying new case	185.50
14	Remote Compact battery case less batteries	21.00
15	Brush head phones less phone plug	6.75
16	Phone plug for head phones	.75
17	100 foot length of 2 conductor microphone cable	9.00
18	250 foot length of 2 conductor microphone cable	22.50
19	Cannon P3-CG-12 plug 3 way locking	1.50
20	Cannon PC-CG-11 extension socket 3 way locking	2.55
21	Collapsible floor stand (music type)	15.00
22	S57B floor stand (solid type)	Deleted, see codes 279, 280
23	Desk Stands (non adjustable)	4.75
24	Complete set of tubes for dynamote, MO-2759	7.60
25	Complete set of tubes for remote conditioner, MO-2760	5.36
26	Complete set of tubes for GR90 remote compact, MO-2799	5.36
27	Complete set of tubes for GR9091 remote foursome, MO-2848	7.76
28	Amperite type PGL microphone 50 ohms with 25 ft. cable	22.50
29	Shure Model 556 microphone less cable (Multimatch 50, 250 ohms or high impedance)	62.75
30	RCA Model 74B Junior velocity microphone	22.45
31	RCA Model 44BX microphone	70.00
32	RCA Model 77D microphone	75.50
33	Western Electric Model 633A microphone	45.00
34	Western Electric 109A swivel for 633A microphone	3.25
35	35' extension cable set for Shure 556A microphone including 2 Cannon connectors	9.75
36	Dynamote amplifier complete, impedance to be stated	255.00
37	GR9091 Remote foursome impedance 250 ohms, complete	325.00
38	GR9091 Remote foursome impedance 30 ohms, complete	325.00

CODE SHEET FOR ORDER ENTRY AND INTEROFFICE COMMUNICATIONS

Code No.	FULL DESCRIPTION	PRICE
39	GR91 four channel mixer unit only for 250 ohms less carrying case with joiner cable	122.50
40	GR91 four channel mixer unit only for 30 ohms less carrying case with joiner cable	122.50
41		
42	GR91 four channel mixer unit for 250 ohms with carrying case and joiner cable, case size for GR9091	152.00
43		
44	GR91 four channel mixer unit for 30 ohms with carrying case and joiner cable, case size for GR9091	152.00
45		
46	Carrying case only for dynamote	27.50
47	RCA type 88A microphone	30.00
48		
49		
50		
51		
52	Model 250C-1 transmitter for frequency of _____ and for 73 ohm transmission line to be equipped with remote reading meter 0-3 RF amp., less tubes and crystals	2535.00
53	Model 250C-1 transmitter for frequency of _____ and for 250 ohm transmission line to be equipped with remote meter 0-3 RF amps., less tubes and crystals	2535.00
54	Model 250C-1 transmitter for frequency of _____ for direct coupling to antenna with 0-3 antenna meter but no remote meter, less tubes and crystals	2575.00
55	Model 250C-1 transmitter for frequency of _____ and for 73 ohm transmission line to be equipped with remote meter for 0-5 amp., less tubes and crystals	2535.00
56	Model 250C-1 transmitter for frequency of _____ and for 250 ohm transmission line and to be equipped with remote meter for 0-5 amp., less tubes and crystals	2535.00
57	Model 250C-1 transmitter for frequency of _____ and for direct coupling to antenna with antenna meter 0-5 amperes, less tubes and crystals	2575.00
	Note—items 52, 53 and 54 same as 55, 56 and 57 respectively other than meter scale readings	
58	Set complete 100% set of tubes for 250C-1 transmitter drawing MO2726	94.08
59	Crystal and oven model BC46T for frequency of _____	50.00
60	Model BC-250D "Customaire" deluxe 250 watt transmitter with two sets of 100% tubes, two crystals and ovens and with Sola constant voltage equipment and choice of remote ammeter. For frequency of _____ and for 73 ohm transmission line	3600.00
61	Model BC-250D "Customaire" deluxe 250 watt transmitter with two sets 100% tubes, two crystals and ovens and with Sola constant voltage equipment and choice of remote ammeter. For frequency of _____ and for 250 ohm transmission line	3600.00
62	Model BC-250D "Customaire" deluxe 250 watt transmitter with two sets 100% tubes, two crystals and ovens and with Sola constant voltage equipment for direct coupling to antenna and for frequency of _____	3675.00
63	Set 100% replacement tubes for BC-250D transmitter to drawing MO2767	99.40
64	250C-1 transmitter for frequency of _____ for 73 ohm line but less remote meter	2500.00
65		
66		

CODE SHEET FOR ORDER ENTRY AND INTEROFFICE COMMUNICATIONS

Code No.	FULL DESCRIPTION	PRICE
67	Model BC1E transmitter for 1000 watts for frequency of _____ and for 73 ohm transmission line, with line meter 0-5 amperes with one set tubes, one crystal and oven	6500.00
68	Model BC1E transmitter for 1000 watts for frequency of _____ and for 73 transmission line, with 0-5 line meter, one set tubes, one crystal and oven and with power reduction to 500 watts	6550.00
69	Model BC1E transmitter for 1000 watts for frequency of _____ and for 250 ohm transmission line with line meter 0-3 amperes, with one set tubes, one crystal and oven	6500.00
70	Model BC1E transmitter for 1000 watts for frequency of _____ and for 250 ohm transmission line with line meter 0-3 amperes, one set of tubes, one crystal and oven and with power reduction to 500 watts	6550.00
71	Model BC1E transmitter for 1000 watts, one set tubes, one crystals and oven but frequency and transmission line not stated when ordered. Frequency will be _____ . Line impedance will be _____ . Line meter will be _____ .	6500.00
72	Set of 100% tubes for BC1E transmitter MO2727	306.88
73	Crystal and oven for BC1E transmitter, Frequency _____	50.00
74	Model 1D transmitter 1000 watts, for frequency of _____ and for 73 ohm line, meter 5 amperes	Deleted
75	Model 1D transmitter 1000 watts, for frequency of _____ and 250 ohm transmission line, meter 0-3 amperes	Deleted
76	Set 100% tubes 1D transmitter MO2728	Deleted
77	BC-46T crystal and oven for 1D transmitter	Deleted
78	_____	
79	_____	
80	_____	
81	_____	
82	_____	
83	Model BC5A broadcast transmitter with 2 sets of tubes, two crystals and ovens and for frequency of _____ and line impedance of _____ ohms with line meter _____ amperes	21,500.00
84	Model BC5A broadcast transmitter with 2 sets of tubes, two crystals and ovens and for frequency of _____ line impedance of _____ line meter to be _____ and power reduction to 1000 watts	21,500.00
85	Set of 100% tubes for BC5A transmitter MO-2729	1194.04
86	_____	
87	_____	
88	Model BC10A transmitter with 2 sets tubes, 2 crystals and ovens for frequency of _____ line impedance of _____ line meter scale _____ amperes	26,500.00
89	Model BC10A transmitter with 2 sets tubes, 2 crystals and ovens for frequency of _____ line impedance of _____ line meter scale _____ amperes with power reduction to _____	26,500.00
90	Set of 100% tubes for BC10A transmitter MO2730	1539.18
91	_____	
92	_____	
93	_____	

CODE SHEET FOR ORDER ENTRY AND INTEROFFICE COMMUNICATIONS

Code No.	FULL DESCRIPTION	PRICE
94	Model HF1X high frequency 1000 watt telegraph transmitter less tubes and crystals, exp. packed	5300.00
95	Set 100% tubes for HF1X transmitter	245.80
96	Model HF1-2 high frequency telegraph and high fidelity broadcast transmitter less tubes and crystals, exp. packed	7100.00
97	Set 100% tubes for HF-1-2 transmitter	416.60
98	MO2 crystal and holder .02 accuracy below 5 Mc frequency of	20.00
99	MO2 crystal and holder .02 accuracy above 5 Mc frequency of	24.00
100	MO3 crystal and holder .005 accuracy for frequency of	52.50
101		
102	Model HF8 high frequency broadcast transmitter less keying provisions, tubes and crystals	21,000.00
103	Model HF8-2 high frequency broadcast transmitter with electronic keyer 300 W.P.M. less tubes and crystals	21,700.00
104	Set 100% spare tubes for HF8 or HF8-2 transmitter, MO-2665	1481.66
105	MO2 crystal and holder above 5 Mc. exact Freq.	24.00
106	MO2 crystal and holder below 5 Mc. exact Freq.	20.00
107	MO3 crystal and holder exact frequency	52.50
108		
109		
110	MO2535 transmitter with one set of tubes, five MO2 crystals and holders and control unit with microphone and key	1790.00
111	Set of 100% tubes for MO-2535 transmitter, MO-2911	48.08
112		
113	Model 21A antenna tuning unit	165.00
114	Model 21B antenna tuning unit	195.00
115	Model 21C antenna tuning unit	117.50
116	Model 21D antenna tuning unit	147.50
117	Model 46A tower coupling unit, diode meter to have scale of 0-3 amperes	375.00
118	Model 46A tower coupling unit, diode meter to have scale of 0-5 amperes	375.00
119	Model 46A tower coupling unit, diode meter to have scale of 0-10 amperes	375.00
120		
121	Model 23A tower lighting choke	55.00
122	Model 23B tower lighting choke	75.00
123	Model 25A frequency control unit less crystals and holders	273.00
124	BC46T oven with crystals for frequency of	50.00
125		
126	Thermocouple type remote meter kit with 0-3 meter 3" square case	35.00
127	Thermocouple type remote meter kit with 0-5 meter 3" square case	35.00
128	MO2765A diode meter unit with 3" meter 0-3 amps.	65.00
129	MO2765A diode meter unit with 4" meter 0-3 amps.	71.00
130	MO2765A diode meter unit with 3" meter 0-5 amps.	65.00

GATES RADIO COMPANY, QUINCY, ILLINOIS, U. S. A.

CODE SHEET FOR ORDER ENTRY AND INTEROFFICE COMMUNICATIONS

Code No.	FULL DESCRIPTION	PRICE
131	MO2765A diode meter unit with 4" meter 0-5 amps.	71.00
132	MO2765A diode meter unit with 3" meter 0-10 amps.	65.00
133	MO2765A diode meter unit with 4" meter 0-10 amps.	71.00
134	Modulation monitor MO2639 with tubes (approval 1556)	310.00
135	Set 100% tubes for MO-2639 monitor, MO-2789	13.18
136	Panel 5¼ by 19" for 3" diode remote meter	6.50
137	Panel 5¼ by 19" for 4" diode remote meter	6.50
138	U bracket complete with center insulator, cable clamps and all material less poles for 6 wire transmission line	15.00
139	End plates complete with all hardware and feed through insulator less pole, for 6 wire line	25.00
140	MO-2870 Feedthru Bowl	9.00
141	Model BF-250A transmitter with 2 sets tubes, 2 crystals and ovens	3650.00
142	Model BF-1A transmitter with 2 sets tubes, 2 crystals and ovens	6500.00
143	Model BF-3A transmitter with 2 sets tubes, 2 crystals and ovens	8500.00
144	Model BF-10A transmitter with 2 sets tubes, 2 crystals and ovens	18000.00
145		
146		
147		
148		
—————		
149	Model 5M dual speech rack with control console and tubes	3500.00
150	Model 5M dual speech rack with control console and tubes to special specifications (see engineering) special quotation	
151	Model 31B console with tubes and metal tilt back cabinet	1060.00
152	Model 31B console with tubes less cabinet	1010.00
153	Extra power supply for 31B console	77.50
154	Complete 100% set tubes 31B console MO2795	22.56
155		
156	Studioette with tubes and power supply and for 30 ohm microphones	435.00
157	Studioette with tubes and power supply and for 250 ohm microphones	435.00
158	Complete 100% tubes for Studioette MO2749	11.28
159	CB4 desk only, no cut-outs or alterations	350.00
160	CB4 desk where alterations of any kind required such as cutting out for other make turntables, etc.	385.00

GATES RADIO COMPANY, QUINCY, ILLINOIS, U. S. A.

CODE SHEET FOR ORDER ENTRY AND INTEROFFICE COMMUNICATIONS

Code No.	FULL DESCRIPTION	PRICE
161	CB4 desk with	350.00
	2-Type CB11 chassis @ 175.00	350.00
	2-Type UL2 vertical lateral reproducers @ 172.00	344.00
	2-61B preamplifiers @ 52.50	105.00
	2-MO2708 preamplifier power supplies @ 20.00	40.00
	1-complete wiring with motor starting switches, master switch and terminal blocks	50.00
	1-Model 31B console	1060.00
	Total	\$2299.00
162	CB4 desk with	350.00
	2-Type CB11 chassis @ 175.00	350.00
	2-Type C15313 lateral pickups @ 75.00	150.00
	2-Preamplifier-power supply kits MO2716C with cables and filters @ 90.00	180.00
	1-complete wiring with motor starting switches, master switch and terminal blocks	50.00
	1-Model 31B console complete	1060.00
	Total	\$2140.00
163		
164		
165	Model CB4 desk with	350.00
	2-Type CB11 chassis @ 175.00	350.00
	2-Western Electric 109A pickups with filters @ 217.25	434.50
	2-Adapter kits for WE pickups for use with Gates turntables @ 15.00	30.00
	2-61B preamplifiers @ 52.50	105.00
	2-MO2708 power supplies @ 20.00	40.00
	1-complete wiring, motor starting and master switches and terminal blocks	50.00
	1-Model 31B console complete	1060.00
	Total	\$2419.50
166	Model CB4 desk with	350.00
	2-type CB11 chassis @ 175.00	350.00
	2-UL2 Vertical lateral pickups @ 172.00	344.00
	2-61B preamplifiers @ 52.50	105.00
	2-MO2708 power supplies @ 20.00	40.00
	1-complete wiring, motor starting and master switches and terminal blocks	50.00
	Total	\$1239.00
167	Model CB4 desk with	350.00
	2-type CB11 chassis @ 175.00	350.00
	2-C15313 lateral pickups @ 75.00	150.00
	2-MO2716 amplifier-power supply units with filters and cables complete @ 90.00	180.00
	1-complete, wiring, motor starting and master switches and terminal blocks	50.00
	Total	\$1080.00
168	Model CB4 desk with	350.00
	2-Type CB11 chassis @ 175.00	350.00
	2-Western Electric 109A with filters @ 217.25	434.50
	2-Adapter kits for WE pickups @ 15.00	30.00
	2-61B preamplifiers @ 52.50	105.00
	2-MO2708 power supplies @ 20.00	40.00
	1-Complete wiring, motor and master starting switches and terminal blocks	50.00
	Total	1359.50
169		
170		

CODE SHEET FOR ORDER ENTRY AND INTEROFFICE COMMUNICATIONS

Code No.	FULL DESCRIPTION	PRICE
171	Model 28CO Limiting amplifier with tubes	319.00
172	Tubes for 28CO Limiter MO2750	12.48
173		
174		
175	Model 6C line amplifier with tubes	250.00
176	Set tubes for 6C amplifier, MO-2752	9.76
177	Model 51 Utility amplifier	150.00
178	Set tubes for 51 amplifier, MO-2874	11.00
179	Model MO2696 monitoring amplifier	150.00
180	Set tubes for MO-2696 amplifier, MO-2791	9.76
181	Model MO2694 program amplifier	135.00
182	Set tubes for MO-2694 program amplifier, MO-2792	5.84
183	MO2883 cueing amplifier with tubes	95.00
184		
185	Model 60A preamplifier with tubes	57.50
186	Model 61A preamplifier with tubes	58.50
187	Set tubes for 60A or 60B amps. MO2753	2.88
188	Model 61B preamplifier or isolation amplifier	52.50
189	Set tubes for 61B amp. MO2755	2.64
190	Model SC1 power supply	37.50
191	Tube for SC1 power supply, MO-2762	.70
192	A5A rectifier for 12 volts DC	55.00
193	A5 rectifier for 6 volts DC	45.00
194	Model 7C volume indicator panel	80.00
195	Model 7D volume indicator	85.00
196	Model 7E volume indicator	90.00
197	Model 7F volume indicator	105.00
198	Model M100 meter panel	55.00
199		
200		
201	Model A130 patch panel	38.00
202	Model A1300 patch panel	58.00
203	Model A1301 patch panel	78.00
204	Model B140 patch panel	43.00
205	Model B1400 patch panel	68.00
206	Model B1401 patch panel	93.00
207	Model C-150 patch panel (single row double jack)	3.85
208	Model C-1500 patch panel (double row double jack)	57.75
209		
210		

CODE SHEET FOR ORDER ENTRY AND INTEROFFICE COMMUNICATIONS

Code No.	FULL DESCRIPTION	PRICE
211	Type D patch cord single plug type 2 foot	7.50
212	Type D patch cord single plug type 3 foot	8.00
213	Type D patch cord single plug type 5 foot	9.00
214	Type E patch cord double plug type 2 foot	10.90
215	Type E patch cord double plug type 4 foot	11.90
216	Type E patch cord double plug type 5 foot	12.40
217	M4900C repeater transformer 500/250/50 ohms, both primary and secondary	15.00
218	LS50 bridging transformer 15,000 ohms—500/250 or 50 ohm secondary	15.00
219	Model UL2DL lateral pickup kit with filter, dial plate but less pre-amplifiers	120.00
220	Model UL2DV vertical pickup kit with filter, dial plate but less pre-amplifiers	150.00
221	MO-2899 pickup kit consisting of UL2DL lateral pickup complete with dial plate, 61B pre-amplifier and MO-2708 power supply	192.50
222	MO-2900 pickup kit consisting of UL2DV vertical pickup complete with dial plate, 61B preamplifier and MO-2708 power supply	222.50
223	Head only for UL2DL lateral pickup	75.00
224	Head only for UL2DV vertical pickup	97.50
225		

226	Model CB11 chassis only, no drilling	175.00
227	Model CB11 chassis mounted in CB7 cabinet with motor switch but no pickups	265.00
228	Model CB7B complete transcription equipment with UL2DL lateral pickup kit which includes preamplifier and power supply	425.00
229	Model CB7C complete transcription equipment with UL2 vertical-lateral pickup, 61B pre-amplifier and power supply	492.00
230	Model CB7D complete transcription equipment with UL2DL lateral pickup and filters but no preamplifier	395.00
231	Model CB7F complete transcription equipment with UL2 vertical-lateral pickup and filters but no preamplifier	432.00
232	Model CB7G complete transcription equipment with W.E. 109A pickup, 61B preamplifier and power supply	536.25
233	Model CB7H complete transcription equipment with W.E. 109A pickup but less preamplifier and power supply	439.25
234	Model CB10 transcription equipment with MO2716C pickup kit includes preamplifier and power supply, lateral type	519.00
235	Model CB10A transcription equipment with UL2 vertical-lateral pickup with preamplifier and power supply	572.00
236	Model CB10B transcription equipment with W.E. 109A pickup with preamplifier and power supply	616.25
237	MO2716C lateral pickup kit includes C15313 lateral pickup, MO2716 three-stage pre-amplifier and MO2708 power supply with all cables and filter switch	Deleted
238	MO2837 vertical-lateral pickup, diamond stylus, with 5 position filter	171.00
239	MO2839 pickup kit includes UL2D (MO2837) vertical-lateral pickup, 61B preamplifier, MO2708 power supply, filter and plate	242.00

GATES RADIO COMPANY, QUINCY, ILLINOIS, U. S. A.

CODE SHEET FOR ORDER ENTRY AND INTEROFFICE COMMUNICATIONS

Code No.	FULL DESCRIPTION	PRICE
240	W.E. 109A vertical lateral pickup	217.25
241	Idler wheel replacement A1939-101 for CB11 turntable	8.00
242	Idler wheel for earlier model CB7 type A1074 for 33 $\frac{1}{3}$ RPM	8.00
243	Idler wheel for earlier model CB7 type A1075 for 78 RPM	8.00
244	UL2 vertical-lateral head only, diamond stylus	112.50
245	Head only for C15313 lateral pickup	55.00
246	Head only for W.E. 109A pickup	
247	Model CB12 recording chassis only, no cabinet or other attachments	225.00
248	Model CB12 recording chassis in CB8R cabinet with starting switch but no attachments	350.00
249	Model CB8R complete recorder includes overhead feed screw at _____ lines per inch to be inside-out, outside-in, with time scale, spiraling, mechanism, microscope, DU4 recording head and lateral playback pickup with filters	1035.00
250	Model AH4 cutting head 500 ohms	90.00
251	Model DU4 cutting head 500 ohms	150.00
252	Feed screw only inside-out 104 lines	60.00
253	Feed screw only inside-out 112 lines	60.00
254	Feed screw only inside-out 120 lines	60.00
255	Feed screw only outside-in 104 lines	60.00
256	Feed screw only outside-in 112 lines	60.00
257	Feed screw only outside-in 120 lines	60.00
258	Complete overhead mechanism with feed screw to be _____ lines _____ with time scale and spiraling attachment less head	197.50
259	RA10 recording amplifier with tubes	295.00
260	100R recording rack with tubes	2012.00
261	Type UL2 vertical-lateral pickup complete with arm, filters and 5 position switch	172.00
262	MO-2924 Pickup kit with lateral RMC pickup, MO-2835 three stage pre-amplifier and MO-2708 power supply	210.00
263	MO-2925 Pickup kit with vertical RMC pickup, MO-2835 three stage pre-amplifier and MO-2708 power supply	235.00
264	MO-2926 Pickup kit with universal vertical-lateral RMC pickup, MO-2935 three-stage pre-amplifier and MO-2708 power supply	290.00
265	Two conductor shielded studio wire per ft.	.06
266	Two conductor shielded rubber-jacketed microphone cable _____ per ft.	.09
267	Cannon connector P3-CG-12 three-way plug	1.50
268	Cannon connector P3-CG-11 ext. socket 3 way	2.55
269	Cannon connector P3-35, wall type 3 way socket	3.15
270	Cannon connector P3-13, socket 3 way chassis type	2.55
271	Cannon connector P4-CG-12 plug 4 way locking	1.50
272	Cannon P4-13 socket 4 way chassis type	2.73
273	Cannon P6-CG-12 plug 6 way locking	1.65
274	Cannon P6-13 socket 6 way chassis type	3.09
275	Hubbel 10 amp. twist lock plug with cap No. 7554	.71

GATES RADIO COMPANY, QUINCY, ILLINOIS, U. S. A.

CODE SHEET FOR ORDER ENTRY AND INTEROFFICE COMMUNICATIONS

Code No.	FULL DESCRIPTION	PRICE
276	Hubbel 10 amp. twist lock motor base socket No. 7557	1.10
277	Hubbel 10 amp. twist lock ext. socket No. 7559	1.32
278	Atlas Boom Stand Type BS-35	38.50
279	Atlas Floor Stand Type MS-24	13.65
280	Microphone floor stand type 425EV	15.75
281	Microphone desk stand type DS7	3.15
282	Meletron boom stand	119.75
283	Model 90C boom stand	85.00
284	Shure model 556 Cardoid microphone (Multimatch 30, 250 and hi-impedance)	62.75
285	Amperite model PGL dynamic mic. with 25 ft. Cable	22.50
286	RCA Model 77D microphone	75.50
287	RCA Model 74B Junior velocity microphone	22.45
288	RCA Model 44BX microphone	70.00
289	Western Elec. 633A microphone	45.00
290	Model 109A swivel for WE633A microphone	3.25
291	35' cable extension set with 2 Cannon connectors for use with Shure 556 microphone	9.75
292	Type BB-1 Atlas Baby Boom Arm with BC-1 Bracket	7.00
293		
294		
295		
296	Jensen Model CRT12 loud speaker in bass reflex floor cabinet with ZY2001 transformer to match 500, 1000, 1500 and 2000 ohms	55.00
297	Jensen Model CRJ-52 loud speaker bass reflex type with extended high frequency range and switch for variable high frequency response for 500 ohm operation	90.00
298	Jensen PM12H loud speaker heavy PM type 12" dynamic with ZY2003 matching trans. for 500, 1000, 1500 and 2000 ohms, no cabinet	22.66
299	Jensen PM10GS dynamic loud speaker PM type with matching transformer ZY2008 for 500, 1000, 1500 and 2000 ohms.	11.24
300	P10J1 Cinaudagraph speaker PM Type 10"	9.24
301	P12M1 Cinaudagraph speaker PM Type 12"	23.40
302	13S42 Transformer for codes 300 or 301 to match to 1500 ohm line	1.80
303	ZY2003 Transformer to match 500, 1000, 1500 and 2000 ohm to voice coil	3.25
304		
305		
306		
307		
308		
309		
310		
311		
312	CB-7I Turntable Complete transcription equipment with UL2DV Vertical Pickup only with pre-amplifier and power supply	455.00

GATES RADIO COMPANY, QUINCY, ILLINOIS, U. S. A.

CODE SHEET FOR ORDER ENTRY AND INTEROFFICE COMMUNICATIONS

Code No.	FULL DESCRIPTION	PRICE
313	Rack cabinet Par-metal 6618 with style trans, approx. height 68"	94.25
314	Rack cabinet Par-metal 8318 with style trims, approx. height 84"	121.95
315	Rack Cabinet Gates deluxe DM1 to match BC1E, BC5A and similar transmitter	140.00
316	Lighting fixture with lights for DM1 cabinet	6.00
317	Joiner trim to join two DM1 cabinets	18.00
318	DM3 cabinet (same as used in Gates BC-250D "Customaire" transmitter)	265.00
319	DM4 cabinet (same as used in BC1E transmitter) only sold for matching phasers, etc.	890.00
320	Type 46 multi-terminal block for terminating audio wires at base of rack cabinet	9.75
321		
322		
323	Attenuator ladder type 1384 as used in Dynamote, Studioette, etc. 30 ohms	9.50
324	Attenuator ladder type 1384 for 250 ohms	9.50
325	Attenuator ladder type 1384 for 500 ohms	9.50
326	Attenuator dual fader 250 ohms for two turntables on one control with center position off	14.00
327	Attenuator No. 1156 ladder type 30 ohms	13.75
328	Attenuator No. 1156 ladder type 250 ohms	13.75
329	Attenuator No. 1156 ladder type 500 ohms	13.75
330	Attenuator No. 1156 ladder type 250/500 ohms	13.75
331	Attenuator bridge T type 50 ohms	19.25
332	Attenuator bridge T type 250 ohms	19.25
333	Attenuator bridge T type 500 ohms	19.25
334	Attenuator potentiometer type 250,000 ohms, type 2900	9.50
335	Attenuator bridge T 250 ohms 180 degree radius type 1013B	13.75
336		
337		
338	Precision fixed pad type 1008 for 10 Db. loss at 500 ohms	7.25
339	Precision fixed pad type 1008 for 5 Db. loss at 500 ohms	7.25
340	Precision fixed pad type 1008 for 15 Db. loss at 500 ohms	7.25
341	Precision fixed pad type 1008 for 20 Db. loss at 500 ohms	7.25
342	Precision fixed pad type 1008 for 30 Db. loss at 500 ohms	7.25
343	Precision fixed pad type 1008 for 40 Db. loss at 500 ohms	7.25
344	Precision fixed pad type 1008 for 50 Db. loss at 500 ohms	7.25
345	Precision fixed pad type 1008 for 60 Db. loss at 500 ohms	7.25
346		
347		
348	Dial plate for any type variable attenuator	.50
349	Kurz Kasch deluxe knob for attenuators	.60
350		
351	3/16" Blank Panels 19" wide, slotted, finished Gates Gray, per inch	.60

CODE SHEET FOR ORDER ENTRY AND INTEROFFICE COMMUNICATIONS

Code No.	FULL DESCRIPTION	PRICE
352	7/8" Coax Cable No. 737, per ft. _____	.80
353	End Seal 7/8", No. 1603R _____	13.50
354	Gas T Inlet for 7/8", No. 1603GV _____	15.00
355	Dry air pump, No. 876 _____	15.00
356	3/8" Coax Cable, No. 83, per ft. _____	.35
357	End Seal 3/8" Coax, No. 1601R _____	12.50
358	Gas T Inlet for 3/8" Coax, No. 1601GV _____	14.00
359	Antenna ammeter Pat. 37 scale 0-3 internal thermocouple _____	12.00
360	Antenna ammeter Pat. 37 scale 0-5 internal thermocouple _____	12.00
361	Antenna ammeter Pat. 37 scale 0-10 internal thermocouple _____	12.00
362	Antenna ammeter 4" Westinghouse scale 0-3 internal thermocouple _____	18.00
363	Antenna ammeter 4" Westinghouse scale 0-5 internal thermocouple _____	18.00
364	Antenna ammeter 4" Westinghouse scale 0-10 internal thermocouple _____	18.00
365	Remote meter thermocouple type scale 0-3 with two 4550 choke coils, 0151 rheostat two type H condensers .005 at 1200 volts _____	35.00
366	Remote meter thermocouple type scale 0-5 with two 4550 choke coils, 0151 rheostat, two type H condensers .005 at 1200 volts _____	35.00
367	Remote meter thermocouple type scale 0-10 with two 4550 choke coils, 0151 rheostat, two type H condensers .005 at 1200 volts _____	35.00
368	5 1/4" by 19" panel drilled for 3" meter as used with thermocouple type remote meters where not mounted on transmitter _____	6.50
369	Studio Light Fixture AM-1 Reads "Studio A" _____	14.95
370	Studio Light Fixture AM-2 Reads "Studio B" _____	14.95
371	Studio Light Fixture AM-3 Reads "Control Rm." _____	14.95
372	Studio Light Fixture AM-4 Reads "On Air" _____	15.50
373	Studio Light Fixture AM-5 Reads as specified _____	16.25

Such items in this price list as are subject to federal excise tax do not include such tax in the prices shown.

The prices shown in this price list are subject to change without notice.

Due to the human element we cannot be responsible for the accuracy of this price list and errors may prevail, though it has been carefully proof read and believed correct.

THE

GATES

Customaire
costs a little more..
worth a lot more!

For 500 or 250 Watts

BC-500D (500 Watts AM)

BC-250D (250 Watts AM)

1. Complete automatic constant voltage regulation for entire transmitter.
2. Dual oscillator-buffer "slide-in" units. Two of everything; crystals, ovens, osc. tube and components, buffer tube and components, metering and controls; means double reliability at the heart of the transmitter.
3. High voltage—low current for P. A. and modulators. Two thousand volts on R. F. Amplifier and 2150 volts on modulators. Less carrier shift, low temperature rise and an excess of modulator reserve power.
4. Semi-pressure-type cabinet—forced air ventilation—insect and dust free.
5. Seven large 4½" meters for easy reading in major circuits. Ten meters in all.
6. 100% parts accessibility. Three front doors, full size back door and sides removable. No hidden parts.
7. Maximum 40 degree centigrade temperature rise all components; more iron and heavier wire in all transformers.



27

27th Anniversary
Year

GATES RADIO CO.

QUINCY, ILLINOIS, U S A

Eastern Zone
GATES RADIO COMPANY
Warner Building
WASHINGTON 4, D. C.

EXCLUSIVE MANUFACTURERS OF RADIO TRANSMITTING EQUIPMENT AND ALLIED PRODUCTS

The "Customaire" is Radio's Finest

For 500 watt or 250 watt operation the Gates "Customaire" stands in a class by itself. Gates engineers were asked to design a transmitter that they would want to buy if the price justified the added facilities these engineers would incorporate. The result is the BC-500D transmitter for 500 watts and the BC-250D transmitter for 250 watts.

These two transmitters are very much alike. Designed for 500 watts it, of course, offers not only an ultra-conservative equipment for 250 watts but a transmitter which may always be increased to 500 watts if the occasion demand. The purchaser is doubly assured of non-obsolescence as frequently a 500 watt daytime station will later desire to become a 250 watt station full time. All of the usual modern features will, of course, be found in the BC-500D and BC-250D transmitters. The unusual features not found in other transmitters are of permanent interest therefore.

The first exclusive feature is emphasized by noting no filament or plate rheostats. This is because 100% constant voltage regulation is provided so that any power line voltage between 190 and 250 volts produces the same transmitter power. To the experienced engineer this is of extreme value both to good operation and permitting the operator to be more attentive to other duties.

Another "Customaire" exclusive is the use of two complete oscillator-buffer assemblies, on a slide-in, plug-in drawer arrangement. Experience has shown that any failure in the all important oscillator is seldom the crystal but usually the tube, a small component or similar. In the "Customaire" are two complete crystals, ovens, oscillator and first intermediate amplifier stages. These can be instantly switched and the faulty unit removed for servicing while the transmitter is on the air.

Other exclusive features are the use of high voltage and low current on both the final radio frequency amplifier and modulators. This means no carrier shift, low operating temperatures, a high reserve in audio power with resultant low distortion and a greater safety factor because of con-



Above is the "Customaire" showing front doors open and wide accessibility to tubes and relays. At the right is a close-up of the frequency control unit section. One control unit is shown partially removed. On the center panel are the tuning controls for the entire transmitter. The center switch selects either control unit, the left switch designates which circuit is being tuned and the right switch shows direction of the adjustment being made. The meter indicates grid current to the 813 exciter stage.



On the left is shown one of the frequency control units removed from the transmitter. Each one contains a complete oscillator and first buffer with crystal and oven. The thermometer on the crystal oven can be viewed thru the vertical slot on the front. Tuning controls and switch for changing the meter from the plate circuit of the oscillator to that of the buffer are located at the bottom of the panel.

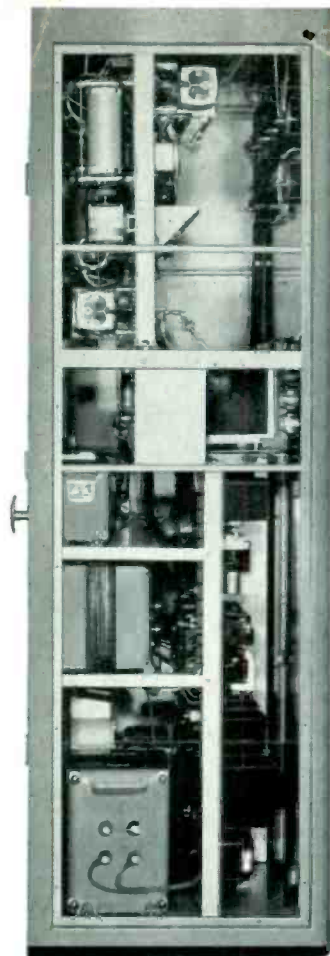

Left View (Sides Off)

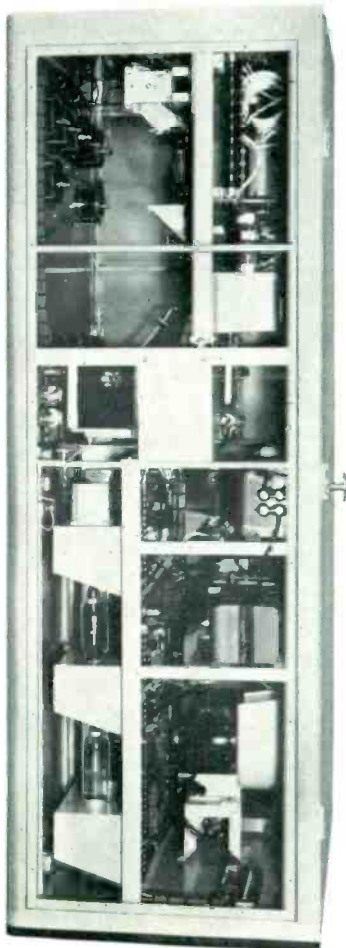

Right View (Sides Off)

Below is shown that portion of the "Customaire" which is seen at the top when rear door is open. Power tubes may be withdrawn thru the rectangular opening. On the right side is the output loading coil and motor assembly and at the bottom is the motor tuned grid circuit for the 813 driver stage.

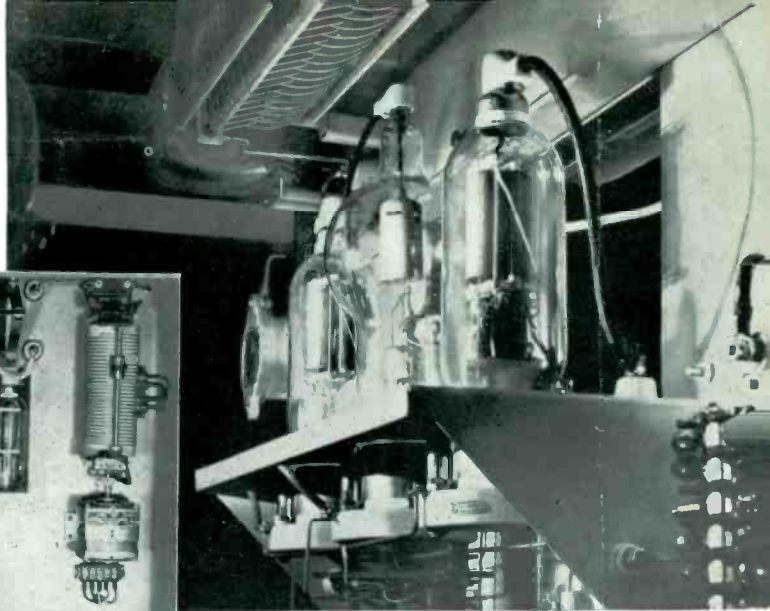
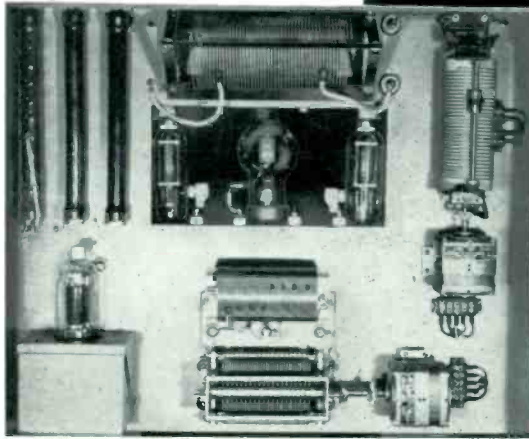

The final amplifier and modulators are shown in the illustration above. A single type 450TH or 250TH may be used for the final amplifier without making any mechanical or electrical changes. The modulators are 810 tubes.

servative currents used. Two large fans are located in the rear top doors which almost instantly remove tube heat and dissipated component warmth from the cabinet. This allows a tight cabinet free from screens or louvers and thus aids in a clean low dust insect free operation. Motor tuning is employed with "no coast" motors. All transformer components, large and small, are potted and fully cased—no open mount transformers are employed in this or any Gates equipment. Note that relays and all but the four large power tubes are available from the front.

The radio frequency portion of the "Customaire" has four stages: 6V6 oscillator, 807 and 813 intermediate amplifiers, and a 450TH tube for 500 watts operation or a 250TH tube for 250 watts. The output tank circuit is series fed and loads with a continuously variable coil in an "L" network. It is designed to match any specified load from 40 to 300 ohms.

The audio frequency portion consists of a push-pull driver stage and a Class B modulator. Inverse feedback of about 6 Db. is employed. The use of high plate voltage on the modulators (2150 volts for 250 watts or 2400 volts for 500 watts) assures an abundance of audio power with low swinging current in the Class B stage. This means unusually fine regulation of the main power supply also.

Power Supplies are abundant in the deluxe "Customaire". A pair of 8008 tubes supply voltage to the R. F. power amplifier and modulators. A pair of 866/866A tubes provides voltage for all other stages and a selenium bias supply assures trouble-free constant bias to the modulator tubes.

Components in a custom built equipment such as the "Customaire" must be the finest. In short, all are over sized. For example, the power transformer in the 500 watt model will deliver 100% more wattage than called upon. All wire and resistors are ferrule type which means immediate replacement when need be and a better resistor mechanically. There has been nothing spared to make the Gates "Customaire" truly alone in the quality field of 250 or 500 watt AM transmitters.

Below: Constant Voltage Transformer

GATES . . . A 100% Source

The transmitter described on these pages is only one of the many hundreds of items in the Gates stock. When purchasing from Gates a complete one source supply is available which means a one source responsibility of Gates, the supplier, to their customers. Whether the needs are small or large. Gates, specializing in radio transmitting equipment, has the many things in stock that others might have to order.

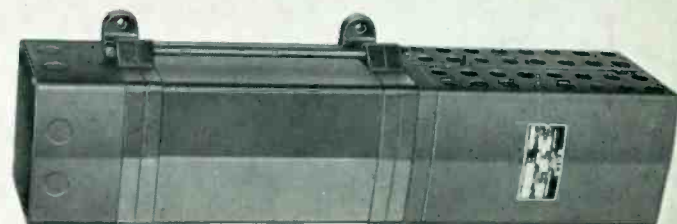

SPECIFICATIONS

FREQUENCY RANGE—530-1600 Kc. (as specified by customer).
POWER SOURCE—230 volts 60 cycles (other voltage and frequencies available).
POWER CONSUMPTION—Seventeen hundred watts.
FREQUENCY STABILITY—Within 10 cycles or better.
RADIO FREQUENCY HARMONICS—Below .05%.
AUDIO INPUT—Requires +15 VU for 100% modulation; input 500/600 ohms.
RESPONSE—Within $\pm 1\frac{1}{2}$ Db., 30-10,000 cycles.
AUDIO DISTORTION— $1\frac{1}{2}$ % or better, 100-5,000 cycles; 3% or better, 50-10,000 cycles.
NOISE LEVEL—60 Db. or better below 100% modulation.
SIZE—78" high, 36" wide, 26" deep. Constant voltage transformer is 31" long, 9 $\frac{1}{2}$ " wide, 8" high.
WEIGHT AND CUBAGE—Domestic packed, 1500 lbs. Export packed, 2200 lbs. Cubage, 87.
TUBES BC-500D (500 watts)—Two each 6V6, 807, 810, 8008, 866/866A, 6L6. One each 813, 450TH.
TUBES BC-250D (250 watts)—Two each 6V6, 807, 810, 8008, 866/866A, 6L6. One each 813, 250TH.
LOADING IMPEDANCE—40-300 ohms as specified by customer.
FCC APPROVAL—Both BC-500D (500 watts) and BC-250D (250 watts) fully FCC approved.

What Is Supplied

As Standard Equipment—Transmitter, 2 sets 100% tubes, 2 crystals and ovens, diode type remote meter equipment complete, constant voltage transformer and instruction book.

Ordering Information

Model BC-500D (500 watts)—Transmitter complete as above. Specify R. F. line meter and diode remote meter scale ranges desired when ordering.
Code ZAVLO.

Model BC-250D (250 watts)—Transmitter complete as above. Specify R. F. line meter and diode remote meter scale ranges desired when ordering.
Code ZAGAR.

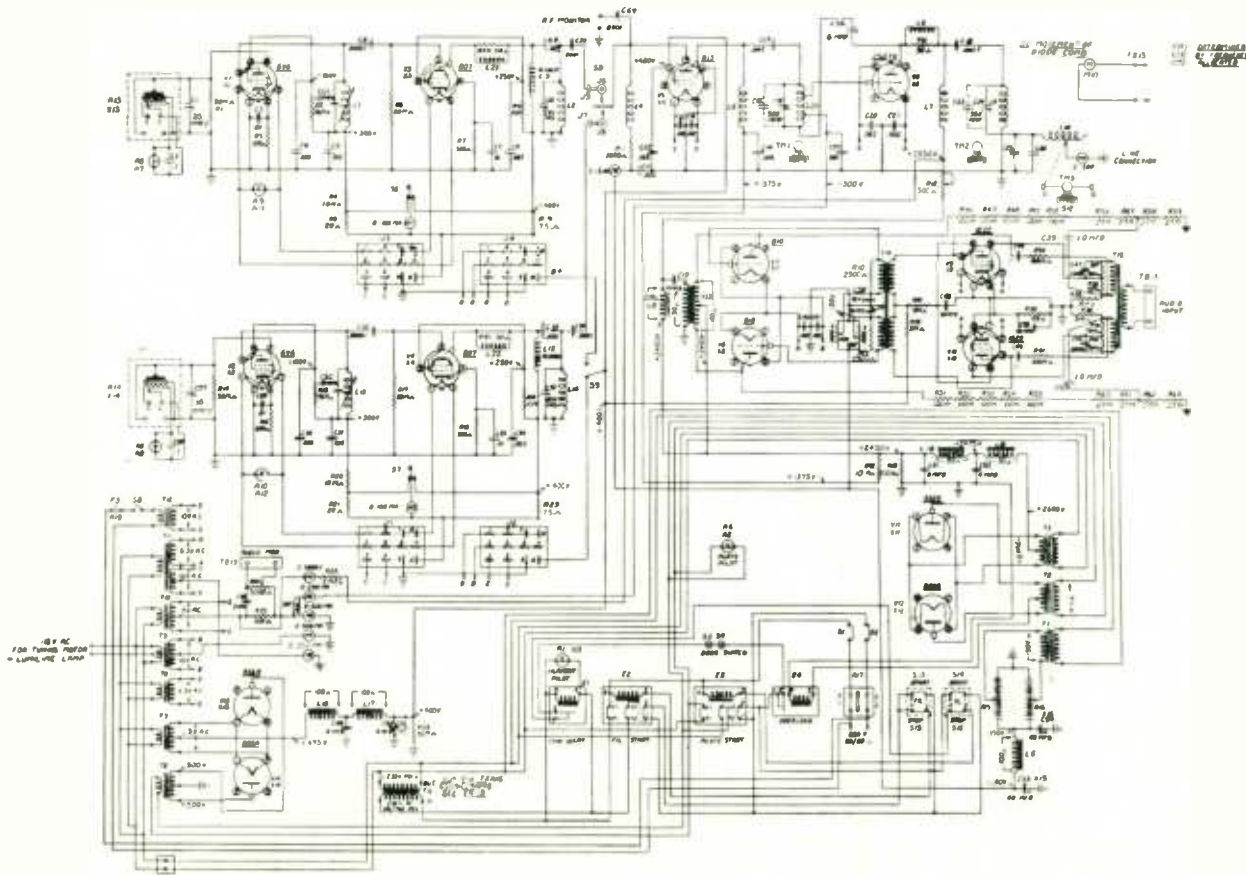

Schematic diagram. The "Customaire" is a conservatively built 500 watt transmitter but may be used for 250 watts, giving double plus reliability.

GATES RADIO COMPANY, QUINCY, ILLINOIS