

**TECHNICAL MANUAL**

**AMS-G1  
AM STEREO GENERATOR**

**988-2363-001**

994 9480 001

**HARRIS**

T.M. No. 888-2363-001  
© Copyright Harris Corporation  
1994, 1995, 1996, 1997  
All rights reserved

Printed : 01-31-95  
Rev. B: 05-29-97

## **Returns And Exchanges**

Damaged or undamaged equipment should not be returned unless written approval and a Return Authorization is received from HARRIS CORPORATION, Broadcast Systems Division. Special shipping instructions and coding will be provided to assure proper handling. Complete details regarding circumstances and reasons for return are to be included in the request for return. Custom equipment or special order equipment is not returnable. In those instances where return or exchange of equipment is at the request of the customer, or convenience of the customer, a restocking fee will be charged. All returns will be sent freight prepaid and properly insured by the customer. When communicating with HARRIS CORPORATION, Broadcast Systems Division, specify the HARRIS Order Number or Invoice Number.

## **Unpacking**

Carefully unpack the equipment and preform a visual inspection to determine that no apparent damage was incurred during shipment. Retain the shipping materials until it has been determined that all received equipment is not damaged. Locate and retain all PACKING CHECK LISTS. Use the PACKING CHECK LIST to help locate and identify any components or assemblies which are removed for shipping and must be reinstalled. Also remove any shipping supports, straps, and packing materials prior to initial turn on.

## **Technical Assistance**

HARRIS Technical and Troubleshooting assistance is available from HARRIS Field Service during normal business hours (8:00 AM - 5:00 PM Central Time). Emergency service is available 24 hours a day. Telephone 217/222-8200 to contact the Field Service Department or address correspondence to Field Service Department, HARRIS CORPORATION, Broadcast Systems Division, P.O. Box 4290, Quincy, Illinois 62305-4290, USA. The HARRIS factory may also be contacted through a FAX facility (217/221-7096).

## **Replaceable Parts Service**

Replacement parts are available 24 hours a day, seven days a week from the HARRIS Service Parts Department. Telephone 217/222-8200 to contact the service parts department or address correspondence to Service Parts Department, HARRIS CORPORATION, Broadcast Systems Division, P.O. Box 4290, Quincy, Illinois 62305-4290, USA. The HARRIS factory may also be contacted through a FAX facility (217/221-7096).

### **NOTE**

The # symbol used in the parts list means used with (e.g. #C001 = used with C001).

## Guide to Using Harris Parts List Information

The Harris Replaceable Parts List Index portrays a tree structure with the major items being leftmost in the index. The example below shows the Transmitter as the highest item in the tree structure. If you were to look at the bill of materials table for the Transmitter you would find the Control Cabinet, the PA Cabinet, and the Output Cabinet. In the Replaceable Parts List Index the Control Cabinet, PA Cabinet, and Output Cabinet show up one indentation level below the Transmitter and implies that they are used in the Transmitter. The Controller Board is indented one level below the Control Cabinet so it will show up in the bill of material for the Control Cabinet. The tree structure of this same index is shown to the right of the table and shows indentation level versus tree structure level.

Example of Replaceable Parts List Index and equivalent tree structure:

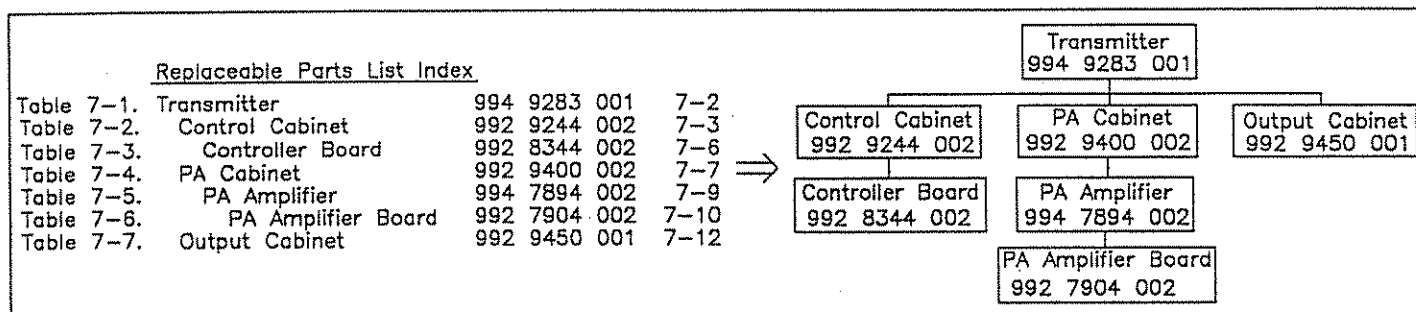

The part number of the item is shown to the right of the description as is the page in the manual where the bill for that part number starts.

Inside the actual tables, four main headings are used:

**Table #.#. ITEM NAME - HARRIS PART NUMBER** - this line gives the information that corresponds to the Replaceable Parts List Index entry;

**HARRIS P/N** column gives the ten digit Harris part number (usually in ascending order);

**DESCRIPTION** column gives a 25 character or less description of the part number;

**REF. SYMBOLS/EXPLANATIONS** column 1) gives the reference designators for the item (i.e., C001, R102, etc.) that corresponds to the number found in the schematics (C001 in a bill of material is equivalent to C1 on the schematic) or 2) gives added information or further explanation (i.e., "Used for 208V operation only," or "Used for HT 10LS only," etc.).

Inside the individual tables some standard conventions are used:

A # symbol in front of a component such as #C001 under the REF. SYMBOLS/EXPLANATIONS column means that this item is used on or with C001 and is not the actual part number for C001.

In the ten digit part numbers, if the last three numbers are 000, the item is a part that Harris has purchased and has not manufactured or modified. If the last three numbers are other than 000, the item is either manufactured by Harris or is purchased from a vendor and modified for use in the Harris product.

The first three digits of the ten digit part number tell which family the part number belongs to - for example, all electrolytic (can) capacitors will be in the same family (524 xxxx 000). If an electrolytic (can) capacitor is found to have a 9xx xxxx xxx part number (a number outside of the normal family of numbers), it has probably been modified in some manner at the Harris factory and will therefore show up farther down into the individual parts list (because each table is normally sorted in ascending order). Most Harris made or modified assemblies will have 9xx xxxx xxx numbers associated with them.

The term "SEE HIGHER LEVEL BILL" in the description column implies that the reference designated part number will show up in a bill that is higher in the tree structure. This is often the case for components that may be frequency determinant or voltage determinant and are called out in a higher level bill structure that is more customer dependent than the bill at a lower level.



MANUAL REVISION HISTORY PAGE  
AMS-G1  
888-2363-001

REV.	DATE	ECN	Pages Affected
001-A	10-16-96	41549	Replaced Title page and page 2-4 Added page MRH-1/MRH-2
001-B	05-29-97	41332	Replaced Title Page, MRH-1/MRH-2 and pages 7-3 to 7-6

888-2363-001

**WARNING: Disconnect primary power prior to servicing.**

MRH-1/MRH-2



**WARNING**

**THE CURRENTS AND VOLTAGES IN THIS EQUIPMENT ARE DANGEROUS. PERSONNEL MUST AT ALL TIMES OBSERVE SAFETY WARNINGS, INSTRUCTIONS AND REGULATIONS.**

This manual is intended as a general guide for trained and qualified personnel who are aware of the dangers inherent in handling potentially hazardous electrical/electronic circuits. It is not intended to contain a complete statement of all safety precautions which should be observed by personnel in using this or other electronic equipment.

The installation, operation, maintenance and service of this equipment involves risks both to personnel and equipment, and must be performed only by qualified personnel exercising due care. HARRIS CORPORATION shall not be responsible for injury or damage resulting from improper procedures or from the use of improperly trained or inexperienced personnel performing such tasks.

During installation and operation of this equipment, local building codes and fire protection standards must be observed. The following National Fire Protection Association (NFPA) standards are recommended as reference:

- Automatic Fire Detectors, No. 72E
- Installation, Maintenance, and Use of Portable Fire Extinguishers, No. 10
- Halogenated Fire Extinguishing Agent Systems, No. 12A

**WARNING**

**ALWAYS DISCONNECT POWER BEFORE OPENING COVERS, DOORS, ENCLOSURES, GATES, PANELS OR SHIELDS. ALWAYS USE GROUNDING STICKS AND SHORT OUT HIGH VOLTAGE POINTS BEFORE SERVICING. NEVER MAKE INTERNAL ADJUSTMENTS, PERFORM MAINTENANCE OR SERVICE WHEN ALONE OR WHEN FATIGUED.**

Do not remove, short-circuit or tamper with interlock switches on access covers, doors, enclosures, gates, panels or shields. Keep away from live circuits, know your equipment and don't take chances.

**WARNING**

**IN CASE OF EMERGENCY ENSURE THAT POWER HAS BEEN DISCONNECTED.**

**WARNING**

**IF OIL FILLED OR ELECTROLYTIC CAPACITORS ARE UTILIZED IN YOUR EQUIPMENT, AND IF A LEAK OR BULGE IS APPARENT ON THE CAPACITOR CASE WHEN THE UNIT IS OPENED FOR SERVICE OR MAINTENANCE, ALLOW THE UNIT TO COOL DOWN BEFORE ATTEMPTING TO REMOVE THE DEFECTIVE CAPACITOR. DO NOT ATTEMPT TO SERVICE A DEFECTIVE CAPACITOR WHILE IT IS HOT DUE TO THE POSSIBILITY OF A CASE RUPTURE AND SUBSEQUENT INJURY.**

## TREATMENT OF ELECTRICAL SHOCK

1. IF VICTIM IS NOT RESPONSIVE FOLLOW THE A-B-C'S OF BASIC LIFE SUPPORT.

PLACE VICTIM FLAT ON HIS BACK ON A HARD SURFACE

### **(A) AIRWAY**

IF UNCONSCIOUS.  
OPEN AIRWAY

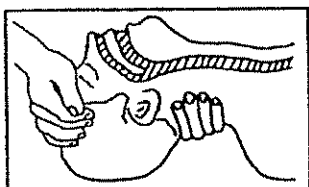

LIFT UP NECK  
PUSH FOREHEAD BACK  
CLEAR OUT MOUTH IF NECESSARY  
OBSERVE FOR BREATHING

CHECK  
CAROTID PULSE

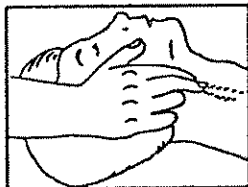

IF PULSE ABSENT.  
BEGIN ARTIFICIAL  
CIRCULATION

### **(B) BREATHING**

IF NOT BREATHING.  
BEGIN ARTIFICIAL BREATHING



TILT HEAD  
PINCH NOSTRILS  
MAKE AIRTIGHT SEAL  
4 QUICK FULL BREATHS  
REMEMBER MOUTH TO MOUTH  
RESUSCITATION MUST BE  
COMMENCED AS SOON AS POSSIBLE

### **(C) CIRCULATION**

DEPRESS STERNUM 1 1/2 TO 2 INCHES

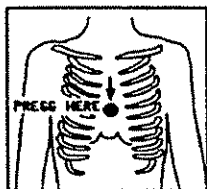

APPROX. RATE  
OF COMPRESSIONS { ONE RESCUER  
--80 PER MINUTE { 15 COMPRESSIONS  
2 QUICK BREATHS

APPROX. RATE  
OF COMPRESSIONS { TWO RESCUERS  
--60 PER MINUTE { 5 COMPRESSIONS  
1 BREATH

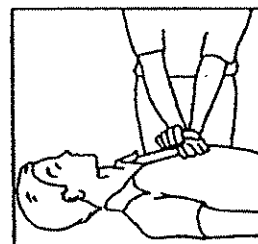

NOTE: DO NOT INTERRUPT RHYTHM OF COMPRESSIONS  
WHEN SECOND PERSON IS GIVING BREATH

CALL FOR MEDICAL ASSISTANCE AS SOON AS POSSIBLE.

2. IF VICTIM IS RESPONSIVE.

- A. KEEP THEM WARM
- B. KEEP THEM AS QUIET AS POSSIBLE
- C. LOOSEN THEIR CLOTHING
- D. A RECLINING POSITION IS RECOMMENDED



## FIRST-AID

Personnel engaged in the installation, operation, maintenance or servicing of this equipment are urged to become familiar with first-aid theory and practices. The following information is not intended to be complete first-aid procedures, it is a brief and is only to be used as a reference. It is the duty of all personnel using the equipment to be prepared to give adequate Emergency First Aid and thereby prevent avoidable loss of life.

### Treatment of Electrical Burns

1. Extensive burned and broken skin
  - a. Cover area with clean sheet or cloth. (Cleanest available cloth article.)
  - b. Do not break blisters, remove tissue, remove adhered particles of clothing, or apply any salve or ointment.
  - c. Treat victim for shock as required.
  - d. Arrange transportation to a hospital as quickly as possible.
  - e. If arms or legs are affected keep them elevated.

#### NOTE

If medical help will not be available within an hour and the victim is conscious and not vomiting, give him a weak solution of salt and soda: 1 level teaspoonful of salt and 1/2 level teaspoonful of baking soda to each quart of water (neither hot or cold). Allow victim to sip slowly about 4 ounces (a half of glass) over a period of 15 minutes. Discontinue fluid if vomiting occurs. (Do not give alcohol.)

2. Less severe burns - (1st & 2nd degree)
  - a. Apply cool (not ice cold) compresses using the cleanest available cloth article.
  - b. Do not break blisters, remove tissue, remove adhered particles of clothing, or apply salve or ointment.
  - c. Apply clean dry dressing if necessary.
  - d. Treat victim for shock as required.
  - e. Arrange transportation to a hospital as quickly as possible.
  - f. If arms or legs are affected keep them elevated.

#### REFERENCE:

ILLINOIS HEART ASSOCIATION

AMERICAN RED CROSS STANDARD FIRST AID AND PERSONAL SAFETY MANUAL (SECOND EDITION)

# Table of Contents

<b>Section I</b>		RF Flow .....	4-1
<b>Introduction/Specifications</b>		Detailed Circuit Analysis of the AMS-G1 .....	4-2
Scope and Purpose .....	1-1	Audio Flow .....	4-2
Specifications .....	1-1	RF Flow .....	4-3
Closed Loop Performance .....	1-1	IQM Correction .....	4-3
<b>Section II</b>		Metering Circuitry .....	4-3
<b>Installation/Initial Turn-on</b>		Power Supply .....	4-4
Unpacking .....	2-1	<b>Section V</b>	
AC Input Wiring .....	2-1	<b>Maintenance/Alignments</b>	
Verifying Proper AC voltage selection .....	2-1	Alignment Procedures .....	5-1
Verifying AC input voltage .....	2-1	GATES/SX IQM Correction .....	5-1
AMS-G1 Rear Panel Connections .....	2-2	IQM Correction Alignment Procedure .....	5-1
AMS-G1 Setup Procedure .....	2-3	Factory Tune-up Procedure For AMS-G1 .....	5-2
Equipment Needed: .....	2-3	Audio Matrix and Equalization .....	5-2
AMS-G1 Interconnections .....	2-3	QUAM Modulator Alignment .....	5-2
Initial Turn-on .....	2-4	Pilot Adjustment .....	5-3
Coarse Delay Equalization Adjustments .....	2-4	Preventative Maintenance .....	5-4
Low Frequency Delay / Day Mode / Left Chan-		Maintenance of Components .....	5-4
nel .....	2-4	<b>Section VI</b>	
Low Frequency Delay / Day Mode / Right		<b>Troubleshooting</b>	
Channel .....	2-5	Introduction .....	6-1
High Frequency Delay / Day Mode / Left Chan-		Power Supply Troubleshooting .....	6-1
nel .....	2-5	Audio Troubleshooting .....	6-1
High Frequency Delay / Day Mode / Right		No L+R Audio to the Transmitter .....	6-1
Channel .....	2-6	Loss of L+R or L-R .....	6-1
Delay Equalization, Night Mode .....	2-6	RF Troubleshooting .....	6-2
Verifying Pilot Level .....	2-7	Underdrive .....	6-2
<b>Section III</b>		Check the RF Output Cable .....	6-2
<b>Operators Guide</b>		QUAM REF Output is okay .....	6-2
Protection of Personnel .....	3-1	QUAM REF Output is Not Okay .....	6-2
AMS-G1 Front Panel .....	3-1	IQM Correction Circuitry .....	6-2
Controls and Indicators .....	3-1	<b>Section VIA</b>	
LED bargraph displays .....	3-1	<b>Emergency Operating Procedure</b>	
Pilot indicator .....	3-1	AMS-G1 Emergency Operating Procedure .....	6-1
Night indicator .....	3-2	<b>Section VII</b>	
10X (ten times) indicator .....	3-2	<b>Replaceable Parts List</b>	
<b>Section IV</b>		<b>Section VIII</b>	
<b>Overall System Theory</b>		<b>Manufacturer Data/Appendix</b>	
Introduction .....	4-1		
Functional Block Diagram Descriptions .....	4-1		
Audio Flow .....	4-1		

## 1.1 Scope and Purpose

This maintenance manual contains the information necessary to install, operate and maintain the AMS-G1, AM Stereo Exciter. The various sections of this manual provide the following types of information.

- a. SECTION I, INTRODUCTION. Provides general manual layout and specifications.
- b. SECTION II, INSTALLATION/INITIAL TURN-ON.
- c. SECTION III, OPERATORS GUIDE. Provides location and function of all controls and indicators and emergency operating procedures.
- d. SECTION IV, THEORY OF OPERATION. Provides block diagram description and detailed circuit analysis.
- e. SECTION V, MAINTENANCE AND ALIGNMENTS. Includes preventive and corrective maintenance and alignment procedures and a component locator.
- f. SECTION VI, TROUBLESHOOTING. Provides information and waveforms for troubleshooting.  
Section VIA, EMERGENCY OPERATING PROCEDURE, provides information on bypassing the AMS-G1.
- g. SECTION VII, PARTS LIST. Provides a complete parts list.
- h. SECTION VIII, MANUFACTURER DATA/APPENDIX. Vendor data on unique components and assemblies.

## 1.2 Specifications

STEREO SYSTEM: C-QUAM AM stereo

AUDIO INPUT: Right and Left channels, +10dBm, balanced 600 ohms or Hi-Z.

AUDIO OUTPUT: Adjustable 0 dBm to +16dBm balanced. +10dBm factory setting.

RF OUTPUT: Fixed TTL level 5V into 50 ohm load, BNC.

STEREO/MONO: Local or remote switchable. Front panel stereo indicator included.

METER FUNCTIONS: L+R, L-R RANGE 0 to 150% modulation. Right, Left meter functions switched at front panel. 10X auto-ranging function.

DELAY CIRCUIT EQUALIZATION: Internally adjustable delay equalization is provided to compensate for phase variations in the broadcast chain. Provides up to 56 microseconds of separately adjustable delay for both day and night modes. Delay is also internally strappable to provide up to 112 microseconds of total delay for one mode and 56 microseconds or less for the other.

FREQUENCY RANGE: 530 to 1705kHz, accommodates 10kHz or 9kHz spacing.

STABILITY: +/-10Hz, 0° to 50°C, crystal controlled, typically +/- 2Hz.

VOLTAGE INPUT: 100, 120, 220 or 240VAC at 50/60 Hz. Rear panel selectable.

AMBIENT TEMPERATURE: 0° to 50°C.

SIZE: 3.5" H x 19" W x 13" D (Fits 19" EIA rack).

8.9cm H x 98.3cm W x 33cm D.

WEIGHT: 8 lbs. (3.6kg).

HUMIDITY: 95% non-condensing.

ALTITUDE: up to 13000 ft. (3962 meters)

### 1.2.1 Closed Loop Performance

DISTORTION: L or R at 70% Mod. 0.7% at 1kHz 1% at full (THD) bandwidth.

L+R at 90% modulation 0.25% full bandwidth.

L-R at 90% modulation 0.5% at 1kHz

1.5% at full bandwidth.

SEPARATION: L+R, L-R 40dB.

L-R - L+R 45dB.

LR or RL 40dB at 1kHz; 30dB at 10kHz.

#### NOTE

*Specifications subject to change without notice.*



## 2.1 Unpacking

Carefully unpack the AMS-G1 and perform a visual inspection to determine that no apparent damage was incurred during shipping. Retain all shipping materials until it has been determined that the unit is not damaged.

The contents of the shipment should be as indicated on the packing list. If the contents are incomplete or if the unit is damaged mechanically, or electrically, notify the carrier and Harris Allied Broadcast (217) 222-8200.

All packing materials must be removed from the equipment before installation. For general domestic shipment of the AMS-G1 no parts are removed before shipment. If for some special reason parts are removed, then all removed components are marked to permit easy reinstallation.

Symbol numbers and descriptions are provided on each removed component corresponding to the schematic diagram, parts list, packing list and reference designator or nomenclature stenciled at the cabinet location of each removed item. Cables and small parts may be taped or tied in place for shipment. Remove all tape, string and packing materials used for this purpose.

The AMS-G1 has a front panel equipped for installation into a standard 19" rack. All connections and all adjustments should be made to the AMS-G1 prior to installation into the rack. All non-factory adjustments for the AMS-G1 (with the exception of the IQM adjustments) are made via access holes in the left side cover.

Figures 2-2, 2-3, and 2-4 illustrate the input/output connectors available at the rear panel of the AMS-G1. With the function of each connector listed in Tables 2-2, 2-3, and 2-4.

### 2.1.1 AC Input Wiring

The AC connection is made at the right hand rear of the AMS-G1 via a standard three prong connector. There is no on/off switch on the exciter. The unit is activated as soon as it is plugged in. The ac input voltage is selectable at 100, 120, 220, or 240Vac. The tag located on the rear panel indicates the input voltage configuration of the exciter at the time of shipment. **THE AC VOLTAGE THAT THE EXCITER WILL BE OPERATED AT MUST BE VERIFIED PRIOR TO PLUGGING IN THE EXCITER AT THE USER LOCATION TO PREVENT DAMAGE TO, OR IMPROPER OPERATION OF, THE EXCITER.** To wire the input of the exciter, refer to the following application notes:

#### 2.1.1.1 Verifying Proper AC voltage selection

#### **CAUTION**

**EXCITER DAMAGE OR IMPROPER OPERATION WILL OCCUR IF THE EXCITER AC INPUT IS NOT SET TO MATCH THE INCOMING AC INPUT VOLTAGE. BEFORE INSERTING THE AC PLUG INTO THE EXCITER, VERIFY THAT THE AC INPUT VOLTAGE MATCHES THAT WHICH THE EXCITER IS SELECTED TO ACCEPT.**

**IF THE AC VOLTAGE RANGE IS CHANGED VERIFY THAT THE PROPER SIZE INPUT FUSE FI, HAS BEEN INSTALLED. EXCITER DAMAGE OR IMPROPER OPERATION COULD OCCUR IF THE WRONG FUSE IS INSTALLED.**

#### 2.1.1.2 Verifying AC input voltage

The ac input voltage to the AMS-G1 should be verified before the exciter is plugged into the ac line, and that the ac input connector is set to the proper range. Failing to do this could result in poor performance due to low input voltage or higher than normal unregulated voltages which could stress devices in the exciter (see table below). The ac input connector block contains the input line fuse and the selector card for setting the ac input voltage. To change the ac input voltage range perform the following steps. Refer to Figure 2-1.

- a. Remove the ac input line cord if installed
- b. Slide the clear plastic cover door to the left, exposing the input fuse and selector card.
- c. Rotate fuse pull lever to the left and remove the fuse.
- d. Remove the voltage selector card by pulling straight out. Putting a loop of wire through the hole in the card and pulling the wire with a pair of needle nose pliers will help in the removal.
- e. Select the proper operating voltage by orientating the card to the position at which the desired voltage range numbers appear on the top left side of the board.
- f. Push board firmly into the module slot and note that the desired voltage range numbers are clearly visible. Rotate the fuse pull lever back to the normal position.
- g. Verify that the fuse is the proper amperage and type (slow blow), then reinsert into the fuse holder. 1/4A slow blow for voltages ranging from 90 to 132Vac or 1/8A slow blow for voltages ranging from 198 to 264Vac.

MEASURED AC INPUT VOLTAGE	AC INPUT VOLTAGE SELECTION
90VAC- 110VAC	100VAC
111VAC- 132VAC	120VAC
198VAC- 230VAC	220VAC
231VAC- 264VAC	240VAC

2357-004

*Table 2-1*

h. Slide the clear plastic cover back over the fuse.

**2.1.2 AMS-G1 Rear Panel Connections**

Refer to Figures 2-2, 2-3, and 2-4 and the corresponding tables for the following connections.

After the proper ac voltage has been verified, connections from the audio source and to the transmitter are next.

**WARNING**

**REMOVE ALL PRIMARY POWER TO THE AMS-G1, THE TRANSMITTER AND THE AUDIO SOURCE BEFORE CONTINUING.**

Referring to Figure 2-2

2. Grounding stud. Provided to utilize a grounding strap and to ground the shield of the PDM Sample.
3. PDM sample. To be connected to an SX or GATES series transmitter's PA Voltage sample.

**NOTE**

*The procedure for connecting the PDM sample cable to a Gates or SX series transmitter is located in Section V, Maintenance and Alignments, under the heading "Gates/SX IQM Correction." The PDM sample is used to improve system performance but is not required for normal operation of the system.*

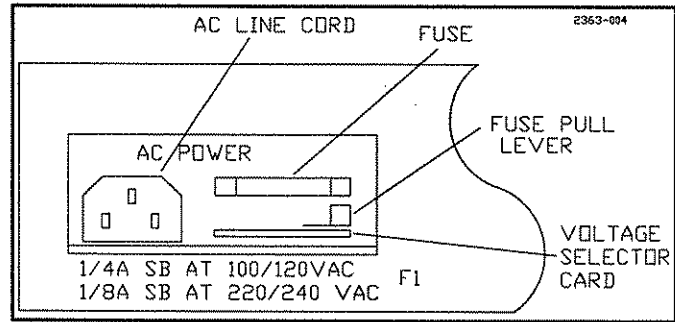

Figure 2-1. AMS-G1 Rear Panel, Left Side

4. Sync. Q reference. This is an unmodulated carrier sample which can be useful for troubleshooting.
5. QUAM REF (reference). This is the output of the quadrature modulators and very useful for troubleshooting.
6. RF output. Connect this to the transmitter's external oscillator input. **REFER TO TRANSMITTER MANUAL FOR THE PROCEDURE OF SWITCHING FROM INTERNAL TO EXTERNAL OSCILLATOR.**

Referring to Figure 2-3 Connector J4 and Table 2-3

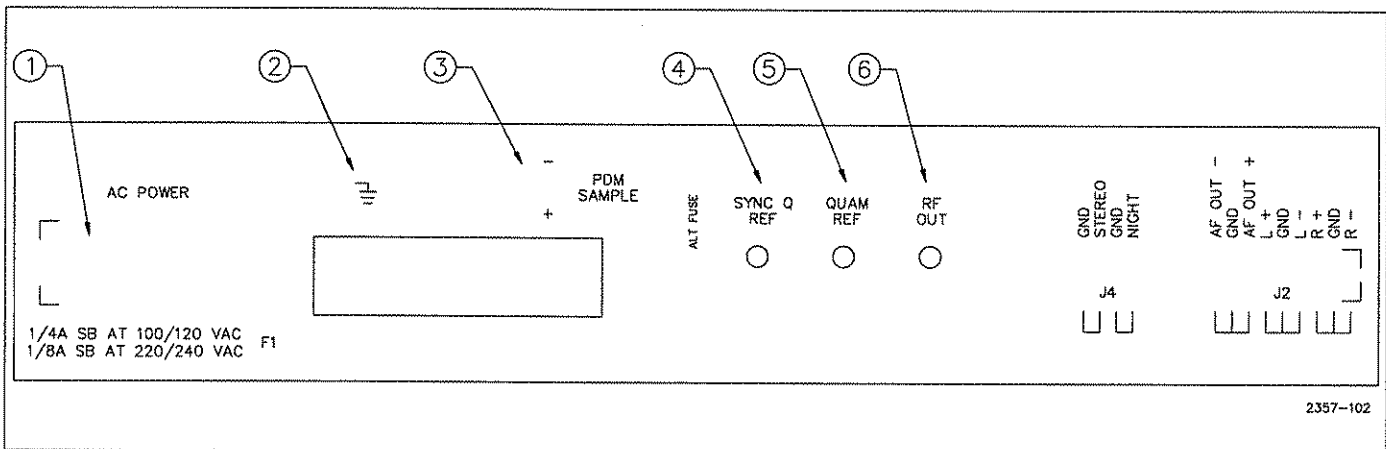

Figure 2-2. AMS-G1 Rear Panel

Table 2-2. AMS-G1 Rear Panel

Ref. # Figure 2-2	Input/Outputs	Function
1	AC Input Line Cord Connector	The line cord connector has a selector card to allow ac input voltage to range from 100-240Vac.
2	Grounding Stud	Provides a terminal for ground strap connection.
3	PDM Sample	When utilizing the IQM feature of the AMS-G1 for SX or GATES Transmitters, a PA Voltage Sample from the transmitter is applied to these inputs.
4	Sync Q Reference Output	This BNC Output Connector is used for frequency counter.
5	QUAM Reference Output	This BNC Output Connector can be used for troubleshooting.
6	RF Out	This BNC Output Connector is the phase modulated carrier waveform. Apply this signal to the transmitter's external oscillator input port. Refer to transmitter manual for locations.

- Pin 1. Night equalization enable, contact closure between this pin and pin 2 will enable the night equalization delay circuitry.
- Pin 3. Stereo mode circuitry enable, contact closure between this pin and pin 4 will enable the stereo circuitry in the AMS-G1.

Referring to Figure 2-4 Connector J2 and Table 2-4

- Pin 1. Right audio input (-) connect to the left channel (-) output of audio source.
- Pin 2. Ground, connect the shield for left channel here.
- Pin 3. Right audio input (+) connect to the left channel (+) output of audio source.
- Pin 4. Left audio input (-) connect to the right channel (-) output of audio source.
- Pin 5. Ground, Connect the shield for right channel here.
- Pin 6. Left audio input (+) connect to the right channel(+) output of audio source.
- Pin 7. AF output, Audio frequency output(+), connect to audio input(+) of transmitter.
- Pin 8. Ground, connect the shield of AF out here.
- Pin 9. AF output, Audio frequency output (-), connect to audio input (-) of transmitter.

Rear panel connections are complete.

## 2.2 AMS-G1 Setup Procedure

The AMS-G1 has been designed so that the following procedure can be accomplished without the removal of the top protective cover. However, some initial jumper settings will require the removal during the initial installation.

Adjustments can be made via the access holes on the exciter's left side panel. See Figure 2-5 and Table 2-5.

### 2.2.1 Equipment Needed:

- a. Audio Function Generator
- b. Dual Trace 40 MHz oscilloscope
- c. C-QUAM Stereo Modulation Monitor
- d. Digital Frequency Counter

### 2.2.2 AMS-G1 Interconnections

Refer to Figure 2-8

- a. Disconnect power from the exciter and remove the top cover (during initial installation only).
- b. Connect the audio output lines from connector J2-7, 8, and 9 to the transmitter audio input connections.
- c. Using RG-58 with BNC connectors, connect the AMS-G1 'RF OUT' to the transmitter 'External Oscillator Input' (this may be labelled 'TTL RF Input'). Setup the transmitter for external RF input. Refer to the transmitter manual for the procedure to switch from internal to external oscillator.

#### NOTE

Early SX transmitters may have a 51 Ohm resistor, R13, near the RF input connector that must be removed so as not to load down the RF output of the exciter.

- d. Place the exciter in the 'Day' mode. This is done by removing any contact closure between J4-1 and J4-2 on the back panel.

Refer to Figure 2-9, Main Circuit Board

- e. Select the proper audio input termination with circuit board jumpers JP1 and JP2. Jumper from pins 3 to 2 for 600 Ohm balanced input or pins 1 to 2 for Hi-Z input.
- f. Place jumper JP4, JP7, JP8, JP9 and JP10 in the appropriate location for the type of Harris transmitter used (either SX or DX).
- g. Place the exciter in the Stereo Mode by providing a contact closure between J4-3 and J4-4. This can be done with a jumper or a remote control system.

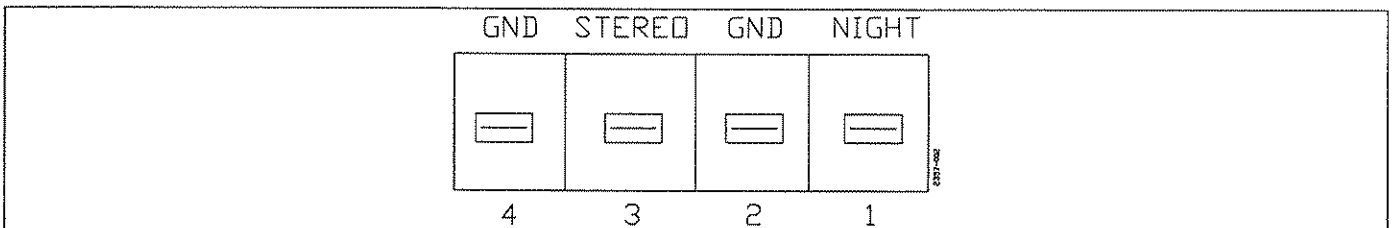

Figure 2-3. AMS-G1 Connector J4

Table 2-3. AMS-G1 Connector J4

Ref.	Connector J4	Function
Figure 2-3	Connector J4	
Pin 1	Night equalization circuitry enable pin	Contact closure either by remote control or a jumper wire between pins 1 and 2 activates night equalization circuitry.
Pin 2	Ground	
Pin 3	Stereo mode circuitry enable pin	Contact closure either by remote control or a jumper wire between pins 3 and 4 places the AMS-G1 in stereo mode.
Pin 4	Ground	

- h. Connect a C-QUAM AM Stereo modulation monitor to the RF sample jack of the transmitter. Set the modulation monitor to the frequency of the transmitter.
- i. Connect the C-QUAM modulation monitor's LEFT output to the oscilloscope's 'X' input.
- j. Connect the C-QUAM modulation monitor's RIGHT output to the oscilloscope's 'Y' input.
- k. Set the oscilloscope to display X-Y input.

**2.2.3 Initial Turn-on**

- a. Apply power to the exciter. Switch the pilot switch S7 into its 'PILOT OFF' position.
- b. Apply power to the transmitter, and increase its power to its nominal operating level. If an underdrive condition is experienced, refer to Section VI, Troubleshooting, for more information on underdrive.
- c. Input a 1kHz, L+R signal at precisely +10 dBm to the inputs of the AMS-G1.
- d. Set the C-QUAM modulation monitor to display the modulation depth for L+R on its left channel meter, and L-R on its right channel meter.
- e. The L+R (amplitude) modulation level should be 100% as indicated by the C-QUAM modulation monitor's left channel meter. If not, then adjust the 'L+R GAIN' control

R63, which is located on the left side of the AMS-G1. If the range of this adjustment is insufficient, re-adjust the audio input attenuator on your transmitter.

**2.2.4 Coarse Delay Equalization Adjustments**

For a detailed description of the delay equalization circuits and their purpose, refer to Section IV, Overall System Theory. All equalization adjustments are located on the left side of the exciter.

**2.2.4.1 Low Frequency Delay / Day Mode / Left Channel**

- a. Set the audio input to 1kHz, at +10 dBm, into the Left audio input of the AMS-G1. The transmitter should be operating into its 'Day' antenna pattern.
- b. Set the C-QUAM stereo monitor to display 'Left' channel modulation on the left channel meter, and 'Right' channel modulation on the right channel meter.
- c. The left channel modulation level should be 50% as indicated by the stereo monitor's left channel meter.
- d. The oscilloscope's lissajous figure should form a flat line parallel to the screen's 'X' or horizontal axis. See Figure 2-6A.
- e. If the oscilloscope's figure is an elliptical loop, as in Figure 2-6B, adjust the stereo exciter's Left channel, Day mode, 'COARSE EQ' switch, S3, in the direction that decreases the loop opening as much as possible.

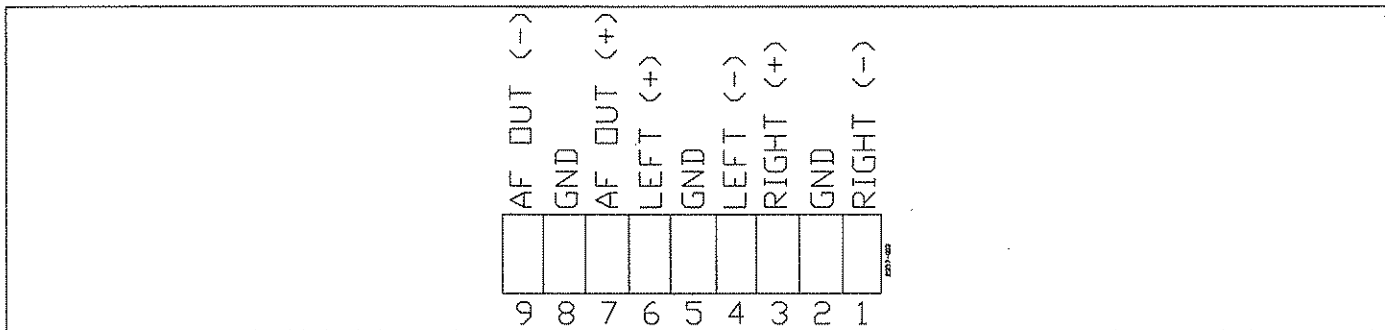

Figure 2-4. AMS-G1 Connector J2

Table 2-4. AMS-G1 Connector J2

Ref. Figure 2-4 Connector J2	Input/Output	Function
Pin 9	Audio frequency output (-)	Pins 7-9 on connector J4 provide the audio input to the transmitter. Pin 9 is the (-) audio, pin 7 is the (+) audio, and pin 8 is to be connected to the shield.
Pin 8	Ground	
Pin 7	Audio frequency output (+)	
Pin 6	Left audio input (+)	The left channel of the audio is to be connected to pins 4-6 on connector J4. Pin 6 is (+) left, pin 4 is (-) left, and pin 5 is to be connected to the shield.
Pin 5	Ground	
Pin 4	Left audio input (-)	
Pin 3	Right audio input (+)	The right channel of the audio is to be connected to pins 1-3 on connector J4. Pin 1 is (-) right, pin 3 is (+) right, and pin 2 is to be connected to the shield.
Pin 2	Ground	
Pin 1	Right audio input (-)	



- f. Adjust the 'L+R GAIN' control, R63, until the lissajous figure is parallel with the screen's 'X' axis.

#### 2.2.4.2 Low Frequency Delay / Day Mode / Right Channel

- Set the audio input to 1kHz, +10 dBm, Right only input.
- The right modulation level should be 50% as indicated by the stereo modulation monitor's right channel meter.
- The oscilloscope's lissajous figure should be a flat line parallel to the display's 'Y' or vertical axis. See Figure 2-7A.
- If the lissajous figure is an elliptical loop, as in figure 2-7B, then adjust the Right channel, Day mode, 'COARSE EQ' switch, S4, in the direction that decreases the loop opening as much as possible.
- If the lissajous figure is not parallel with the screen's 'Y' axis, re-adjust the 'L+R GAIN' control. Some iteration of

the R63 setting may be necessary to find the best compromise between a horizontal, left-channel signal, and a vertical, right-channel signal.

#### 2.2.4.3 High Frequency Delay / Day Mode / Left Channel

- Set the audio generator for 10 kHz, +10 dBm, Left only input.
- The left modulation meter should read 50%, as indicated by the stereo modulation monitor's left channel meter.
- The oscilloscope's lissajous figure should be a flat line that is parallel with the display's 'X' axis (horizontal).
- If the oscilloscope's lissajous figure is an elliptical loop, or is not parallel with the display's 'X' axis, adjust the Left channel, Day mode, 'FINE EQ' adjustment R69, until the opening of the loop closes. The 'HF BOOST' pot, R75,

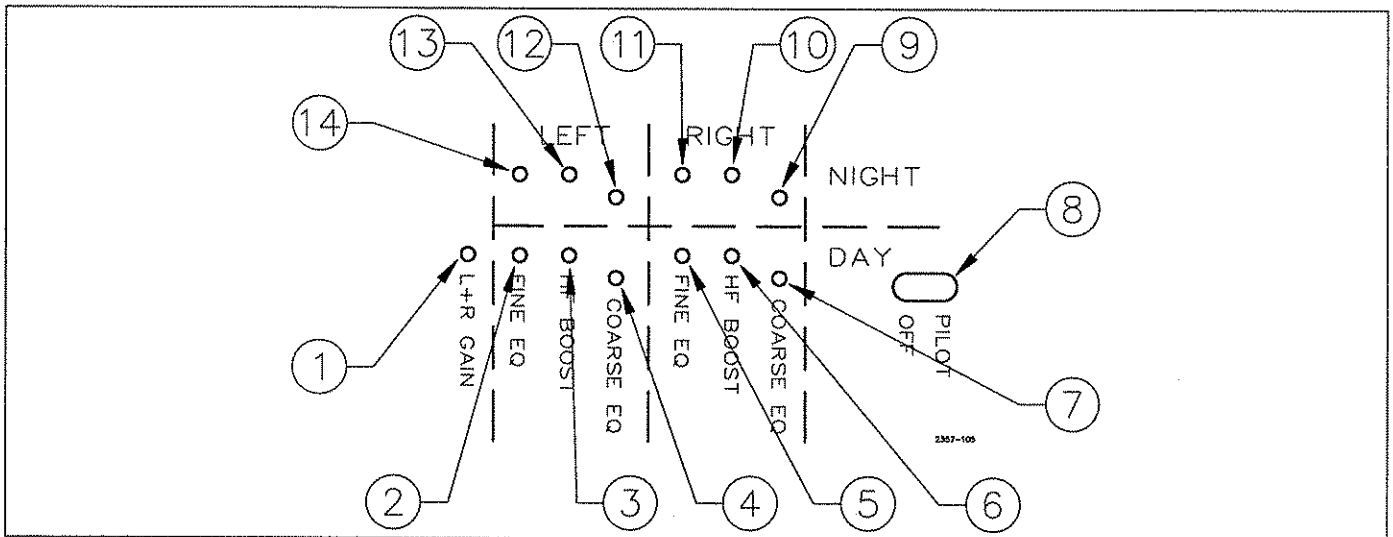

Figure 2-5. AMS-G1 Side Panel Adjustments

Table 2-5. AMS-G1 Side Panel Adjustments

Ref. Fig. 1-5	Description	Designator
1	Left plus Right Gain potentiometer	R63
2	Left "Day" Fine Equalization potentiometer	R69
3	Left "Day" High Frequency Boost potentiometer	R75
4	Left "Day" Coarse Equalization switch	S3
5	Right "Day" Fine Equalization potentiometer	R82
6	Right "Day" High Frequency Boost potentiometer	R87
7	Right "Day" Coarse Equalization switch	S4
8	Pilot on-off switch	S7
9	Right "Night" Coarse Equalization switch	S6
10	Right "Night" High Frequency Boost potentiometer	R274
11	Right "Night" Fine Equalization potentiometer	R271
12	Left "Night" Coarse Equalization potiometer	S5
13	Left "Night" High Frequency Boost potentiometer	R266
14	Left "Night" Fine Equalization potentiometer	R259

may also need to be varied to improve loop closure, or move the loop parallel to the scope axis.

**2.2.4.4 High Frequency Delay / Day Mode / Right Channel**

- a. Set the audio generator for 10 kHz, +10 dBm, Right only input.
- b. The Right channel modulation level should read 50% as indicated by the C-QUAM modulation monitor's right channel display.
- c. The oscilloscope's lissajous figure should be a flat line that is parallel with the display's 'Y' axis (vertical).
- d. If the lissajous figure is an elliptical loop, adjust the Right channel, Day mode 'FINE EQ' pot R82, until the opening of the loop closes, and the loop becomes parallel with the scope's "Y" axis. It may also be necessary to adjust the right channel 'HF BOOST' adjustment pot R87 to improve loop closure or move the loop parallel to the scope axis.
- e. Once the high frequency equalization has been set, it will be necessary to repeat the low-frequency equalization procedure. This is to compensate for any affect the high-frequency equalization settings have had on the low frequency channel separation. Compromise settings may have to be found for R69, R75 and S3 for the Left channel, and R82, R87 and S4 for the Right channel, to arrive at the best overall stereo separation at both 1 and 10 kHz.

**Note**

If the lissajous figure is curved, or is not parallel to the display's 'X' or horizontal axis as in Figure 2-6C, then there is appreciable IQM present within the transmitter. If so, it is recommended that the operator should perform the "IQM Correction Alignment Procedure," located in Section V, Maintenance/Alignments, at this time. (This applies to SX and Gates transmitters only). It will then be necessary to come back and do the Delay Equalization procedure again.

**2.2.4.5 Delay Equalization, Night Mode**

To equalize the delay in the Night mode, the transmitter must be operated into the Night antenna pattern, and the AMS-G1 be placed into its Night mode. The alignment procedure is analogous to that of the Day mode, using the analogous pots and switches marked for the Night mode, R259, R266 and S5 for the Left channel, and R271, R274 and S6 for the Right channel.

**Note**

When optimizing in the Night Mode, do not change the setting of the L-R Gain pot R165 or the L+R Gain pot R63. Only the switches and pots which are accessible from the side panel should be used to optimize performance in the Night Mode.

For those stations possessing extremely narrow-band antenna systems, more than 55 microseconds of delay equalization may be required for proper stereo performance. It is possible to cascade the day and night equalization sections so as to effectively double the range of delay available. This is done by placing jumpers JP5 and JP6 in the '1-2' positions. Refer to Figure 2-9. This will not change

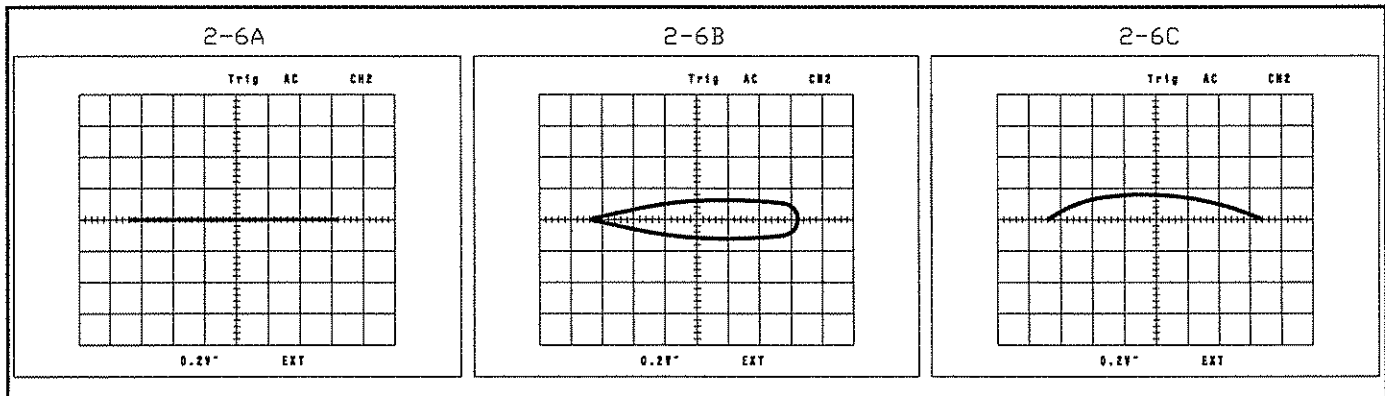

Figure 2-6. Lissajous Waveforms for Left Channel Delay Equalization Adjustments

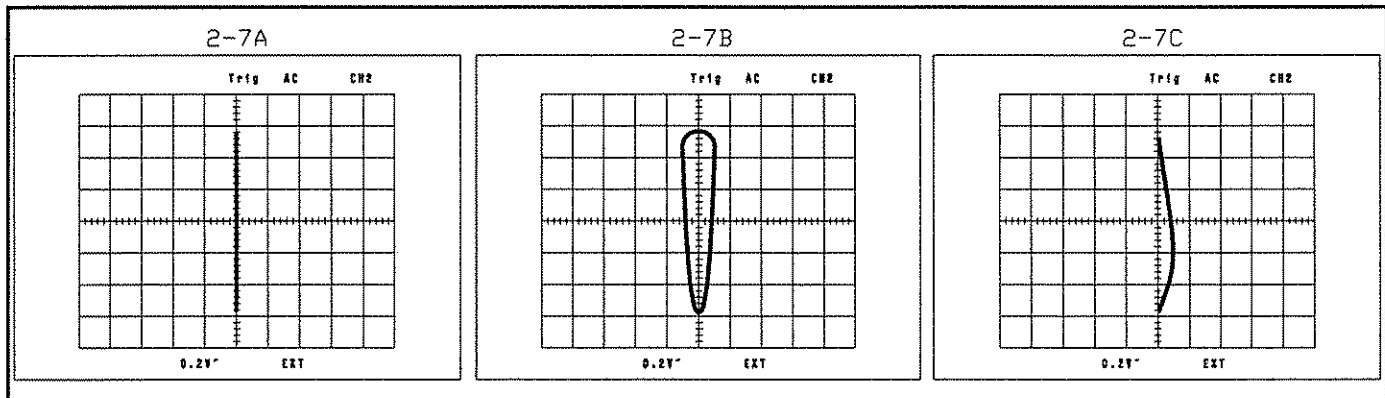

Figure 2-7. Lissajous Waveforms for Right Channel Delay Equalization Adjustments

the delay available in the day equalization section, but the night pattern equalization delay will be summed into the day delay, allowing up to 110 microseconds of range of delay equalization for the night pattern (maximum delay will be equal to the amount of "Day" EQ delay plus up to 55 microseconds more in the "Night" mode).

#### 2.2.4.6 Verifying Pilot Level

Following the equalization process, switch the pilot switch S7 into its 'PILOT ON' position. Using your stereo monitor, verify that in the absence of audio programming, the pilot level is 5% modulation in the L-R channel.

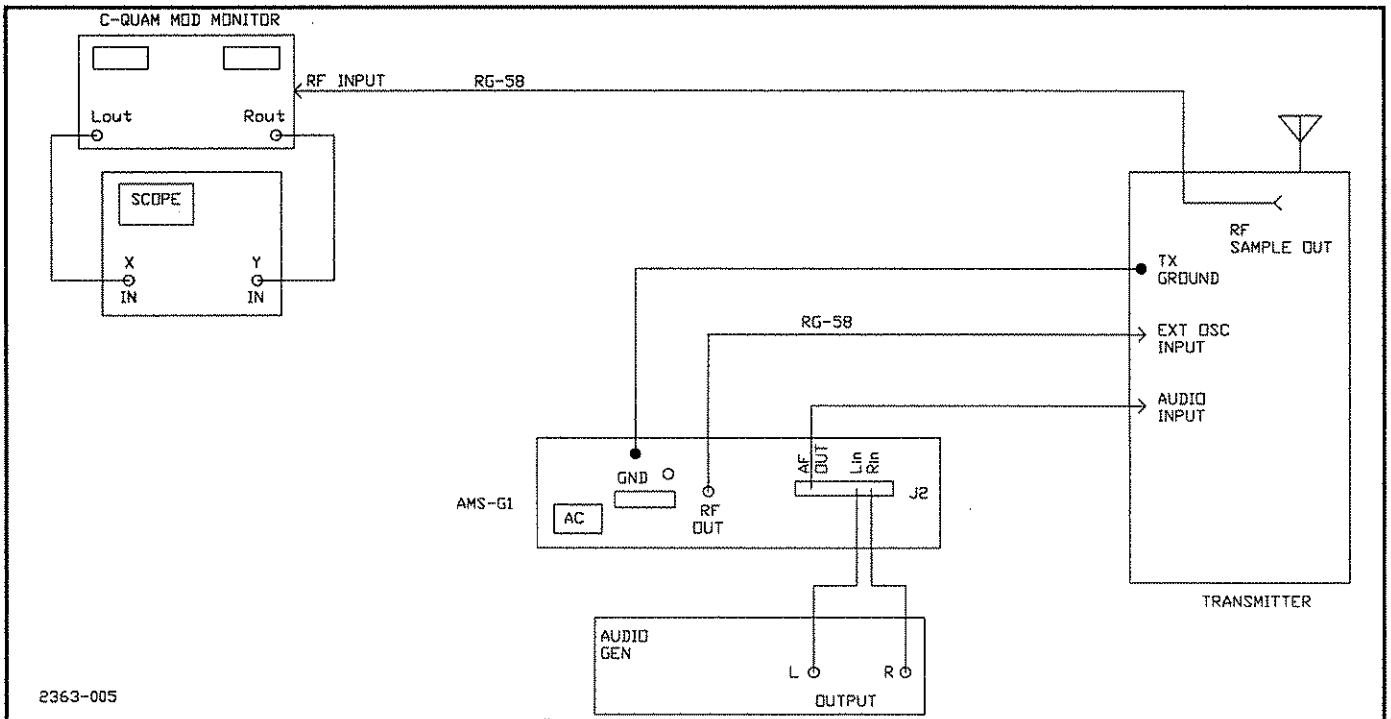

Figure 2-8. AMS-G1 Interconnect Wiring

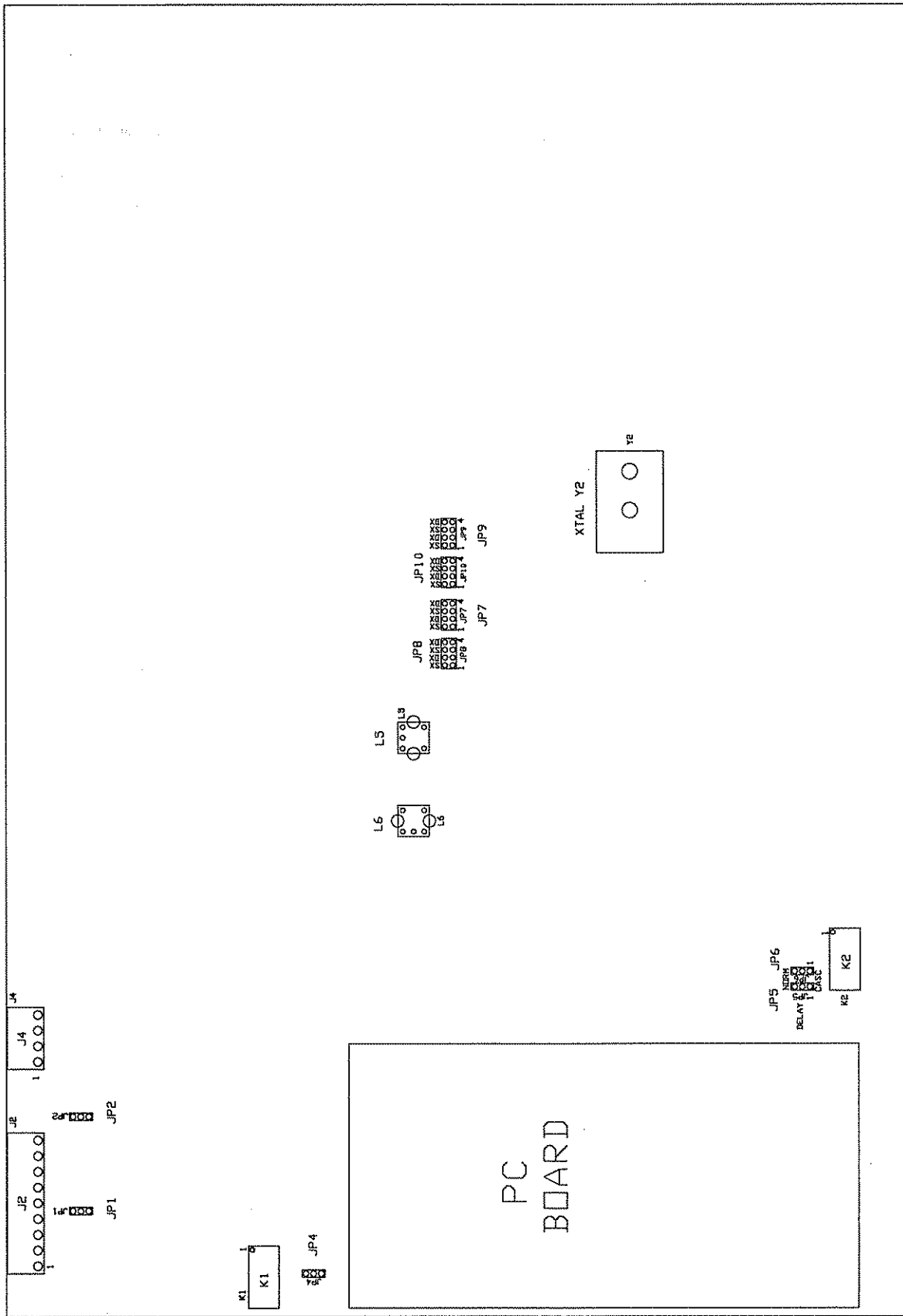

Figure 2-9. Main Circuit Board

## 3.1 Protection of Personnel

The exciter has no on/off switch. When the AC power cord is plugged in the unit becomes active. To ensure operator safety a metal cover has been installed atop the AMS-G1. It is attached with ten phillips head screws. Upon removal of the cover the operator or technician is further protected by two lexan shields. One shield prevents contact to primary AC input while the other covers the high voltage PDM sample that will be present if the Incidental Quadrature Modulation (IQM) correction feature of the AMS-G1 is utilized.

## 3.2 AMS-G1 Front Panel

The exciter is equipped with two audio level LED bargraphs and a rocker switch which allows the operator to select the input to the LED bargraphs. There are two possibilities; Left plus Right audio/Left minus Right audio or Left/Right audio. This feature of the AMS-G1 is a helpful troubleshooting aid in determining whether the audio source is functioning properly.

Figure 3-1 Illustrates the controls and indicators available from the exterior of the exciter, with the function for each control or indicator given in Table 3-1.

## 3.3 Controls and Indicators

### 3.3.1 LED bargraph displays

The AMS-G1 is equipped with two LED bargraph displays. The display to the far left of the unit is the Left audio amplitude or Left plus Right audio amplitude indicator. The display to the far right of the unit is the Right audio amplitude or Left minus Right audio amplitude indicator. The selection between the Left audio/Right audio and the Left+Right audio/Left-Right audio is made by the rocker switch in the middle of the front panel. It is important to point out that this switch does not take the transmitter out of stereo mode nor will it engage stereo operation of the transmitter, but only affects the LED bargraph metering mode.

### 3.3.2 Pilot indicator

In a C-QUAM signal there is a 25 Hz pilot signal present in the Left minus Right audio. The pilot indicator when illuminated

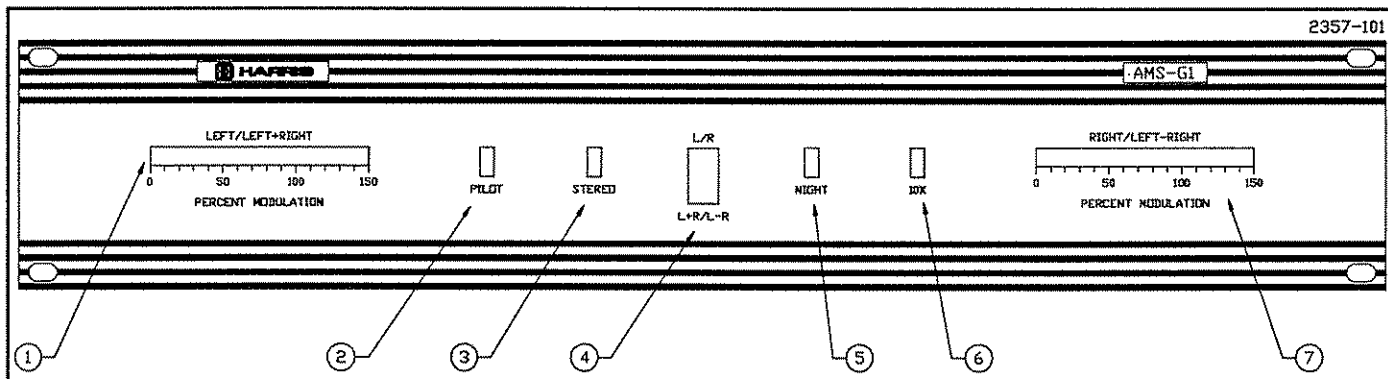

Figure 3-1. AMS-G1 Front Panel

Table 3-1. AMS-G1 Front Panel

Ref. # Fig. 3-1.	Control/Indicator	Function
1	Left/Left + Right Audio Amplitude LED Bargraph	Indicates amplitude of Left or Left Plus Right audio.
2	Pilot Indicator	When illuminated, indicates that 25Hz Pilot frequency is present.
3	Stereo Indicator	When illuminated, indicates the AMS-G1 is in the stereo mode.
4	LED Bargraph Metering Switch	Allows operator to change the bargraph meters from L+R/L-R amplitude readings to L/R amplitude readings and visa versa.
5	Night Indicator	When illuminated, indicates Night equalization circuitry is active.
6	10X Indicator	When illuminated, indicates AMS-G1 automatic 10X metering circuit is active.
7	Right/Left-Right audio amplitude LED Bargraph	Indicates amplitude of Right or Left Minus Right audio.

verifies that the 25 Hz pilot signal is turned on. The Pilot on/off switch is located on the motherboard and is accessed from the left side of the unit.

### **3.3.3 Night indicator**

The AMS-G1 normally operates in the Day equalization mode. In stations with a separate night antenna pattern, separate equalization circuitry has been provided for the differing equalization requirements of the night antenna pattern. The night indicator provides a visual representation that this alternate circuitry has been activated.

### **3.3.4 10X (ten times) indicator**

The exciter is equipped with an automatic ten times metering circuit that is activated if the program material causes the transmitter's modulation level to fall to a level less than 10%. When the ten times circuitry is activated the 10X led is illuminated, and the audio input signals to the LED bargraphs are amplified by a factor of ten, which allows very soft passages in program material to still be plainly measured on the bargraphs.

## 4.1 Introduction

This section contains detailed functional block diagram descriptions and detailed circuit analysis necessary for understanding the theory of operation of the AMS-G1 exciter.

### Note

An introduction to the C-QUAM AM Stereo System, provided by Motorola, is included in Section VIII, Appendix. If you are not familiar with the C-QUAM theory of operation, it is recommended that Appendix A be read before proceeding.

## 4.2 Functional Block Diagram Descriptions

The functional block diagram is drawing number 839-8138-105, and is located in the schematic drawing package.

### 4.2.1 Audio Flow

#### *Mono Audio Path, L+Re*

The left and right balanced audio inputs are filtered and sent to differential amplifiers whose outputs are single ended left and right audio. The left and right signals are sent to S2 (the front panel switch) for metering, K1 for stereo mode, and to the Envelope Balance pot. The Envelope Balance pot adjusts the mixture of left and right audio into the L+R summing amp. The output of the summing amp is called L+Re, where "e" stands for envelope. This is the monaural signal for the transmitter.

JP4 allows for 5 microseconds of delay to be added into the audio path for the DX series transmitter. This delay will be bypassed for the SX or Gates series transmitter. The audio is then returned to balanced form and sent to the transmitter audio input.

#### *Stereo/Mono Mode*

Left and right audio, before the mono summing amp, is sent to the Stereo/Mono relay K1. K1's normal position puts the exciter in mono mode. In the stereo mode, the stereo relay driver circuit will activate K1 and the left and right audio will also be sent to the delay equalization circuitry. An LED will be illuminated on the front panel when in stereo mode.

#### *Stereo Signal Path and Delay Equalization*

The Delay Equalization circuitry compensates for the effects of unmatched group-delay between the transmitter's RF and Audio circuit paths, and to correct for the effects of a narrow-bandwidth antenna system. The two signal paths, Audio and RF, must have equal time delays since the audio path carries the mono information and the RF path carries the stereo information (in the form of phase modulation of the carrier). Since the frequency responses of a station's day and night pattern antenna arrays are likely to be different, a separate equalization section is provided for both the day and night patterns.

There are four separate, but identical, delay equalization circuits. Two are for the daytime pattern (left and right), and two are for the nighttime pattern (left and right). Relay K2 selects the audio out of either the day or the night equalization circuits. When

activated by the relay driver, Night Mode is selected. An LED will also be illuminated on the front panel when in the night mode. Each separate delay circuit can supply approximately 55 microseconds of delay.

Jumpers, JP5 and JP6, can be used to cascade the delay of the day circuits into the night delay circuits. This allows for extra delay in the night mode, but has no effect on the day mode. The audio outputs of the delay circuits pass through K2 to the audio matrix circuits and are labelled L\_EQ\_Delay and R\_EQ\_Delay.

#### *L+Rq/L-Rq Audio Matrix*

The left and right signals, from the delay circuits, are now matrixed into L+Rq and L-Rq, where "q" stands for quadrature. L+Rq Null and L-Rq Null are used to adjust for the proper balance of left and right. The L+Rq signal is negative peak limited and sent to S2 for metering. It is also sent as the input to one of the two C-QUAM balanced modulators. The L-Rq signal amplitude is adjusted by the L-R Gain pot and sent to S2 for metering and to the second C-QUAM balanced modulator input.

#### *Metering*

The front panel bargraph displays can be used to monitor Left and Right audio, from TP1 and TP3 or can be switched, with S2, to monitor L+Rq and L-Rq from TP10 and TP12. Switch S1, located on the motherboard, is used to allow the L+R bargraph display to monitor the L+Re signal from TP4.

### 4.2.2 RF Flow

#### *Carrier Generator (Without IQM Correction)*

The carrier frequency of the AMS-G1 is generated in a crystal oscillator which is 4 times that of the carrier frequency. The output of the crystal oscillator is coupled into a Johnson counter which divides the oscillator frequency by four, yielding four outputs at the carrier frequency, at 0, 90, 180, and 270 degrees.

The in-phase (0 and 180) and quadrature (90 and 270) RF carrier components are used to drive the balanced modulators. The outputs of the modulators are summed together, creating a phase and amplitude modulated signal, or QUAM signal. The harmonic energy is then attenuated in the band pass filter which is adjustable via L5 and L6.

#### *Buffer/Limiter*

The QUAM signal is then buffered and hard limited, before being sent to a 50 ohm line driver. The output of the line driver is a TTL level signal at the carrier frequency. This signal is used to replace the transmitter's internal crystal oscillator. It is a phase modulated signal which contains the stereo information.

#### *Carrier Generator (With IQM Correction)*

If the AMS-G1 is to be used with a Gates or SX transmitter, optimum performance will be obtained by moving jumpers JP7 thru JP10 to positions 1 and 3. This will route the in-phase and quadrature signals through the IQM Correction circuitry before going to the balanced modulators.

### *IQM Correction*

The IQM Correction circuitry uses a sample of the transmitter PDM Voltage (it is actually the voltage across the PA, from the HV to the PDM line) which varies with modulation. This sample is used to add phase shift to the carrier which will offset the phase shift introduced by the transmitter power amplifiers, resulting in minimum IQM. This phase corrected sample is then used to drive the two C-QUAM balanced modulators.

#### *Pilot*

The Pilot oscillator is running at 25.6kHz. It is divided by 1024 and bandpass filtered to provide a 25Hz sinewave to the L-Rq modulator. The Pilot level is adjusted by the Pilot Level pot. The Pilot can be switched on and off. When it is switched on, an LED will be illuminated on the front panel.

## 4.3 Detailed Circuit Analysis of the AMS-G1

### 4.3.1 Audio Flow

#### *Audio Input*

The left and right channel audio input signals enter the board through connector J2, at the rear of the unit. Jumpers JP1 and JP2 terminate the audio input lines with a 600 ohm impedance, where appropriate. After passing through RF filtering and transient suppression, the left and right channel audio is differentially amplified and buffered through sections of U1, a TL074. The Left and Right audio signals are sent to front panel switch S2, for metering purposes, and are also summed together by one section of U2 to form the Mono or L+Re signal (e = envelope). The left and right amplitudes are adjusted at the input to the summing amplifier by R32, Envelope Balance. For units intended to be used with DX-series transmitters, JP4 is placed in the '1-2' position, which places 5 microseconds of delay in the transmitter audio path. The L+Re signal amplitude is then adjusted by the L+R Gain pot, R63, buffered by U3 and leaves the board via J2-7 and J2-9 as a balanced audio signal. This L+Re signal is sent to the transmitter audio input. It should be noted that the L+Re signal is constructed by summing the left and right channel signals, prior to delay equalization.

#### *Stereo-Mono Selection*

The AMS-G1 can be operated in either the Stereo or Mono mode. The Stereo mode is selected by making a connection between J4-3 and J4-4 at the rear of the unit. This causes closure of relay K1, directing the left and right channel audio information into the Delay Equalization circuitry, and illumination of the Stereo LED on the front panel. If K1 is open, no signal is received by the Delay Equalization circuitry, and no stereo information will be transmitted. The mono (L+Re) signal will be sent to the transmitter audio input in both Mono and Stereo mode.

#### *Day-Night Delay Equalization*

The delay equalization networks consist four identical, switch-selectable, low-pass filters allowing up to 45 microseconds of delay in 3 microsecond steps. These networks are followed by continuously-variable low-pass filters which provide 0 to 10 microseconds of adjustable delay. See Table 4-1.

*Table 4-1. Delay Adjustments*

Course Adjustment (3 microsecond Steps)	Fine Adjustments (0 to 10 microseconds)
S3 - Left Channel - Day Delay Equalizer	R69
S4 - Right Channel - Day Delay Equalizer	R82
S5 - Left Channel - Night Delay Equalizer	R259
S6 - Right Channel - Night Delay Equalizer	R271

The high frequency response of each of the delay circuits is also adjustable, to allow for compensation of the high-frequency amplitude response of the transmitted signal. Op-amps U4 and U5 provide delay equalization for the left channel, day pattern; U6 and U7 are for the right channel, day pattern; U23 and U24 are for the left channel, night pattern, and U25 and U26 are for the right channel, night pattern. The night pattern equalization circuitry is contained in a plug-in board mounted directly above the day pattern equalization circuitry.

For those stations possessing extremely narrow-band antenna systems, more than 55 microseconds of delay equalization may be required for proper stereo performance. It is possible to cascade the day and night equalization sections so as to effectively double the range of delay available in the night mode. This is done by placing jumpers JP5 and JP6 in the '1-2' positions. This will not change the delay available in the day mode, but the night pattern equalization delay will be summed with the day delay, allowing up to a 110 microsecond range of delay equalization for the night pattern.

#### *Day/Night Equalization Selection*

The AMS-G1 normally operates in the Day equalization mode. To select the Night equalization mode, a contact closure must be made between J4-1 and J4-2 at the rear of the unit. This causes closure of relay K2, which then selects the output of the Night equalization circuitry, instead of the day. This also illuminates an indicator LED on the front panel.

#### *Night Always Mode, JP3*

If there is only one pattern, and more than 55 microseconds of delay is needed, then JP3 can be placed in the 2-3 position. This will place the AMS-G1 in the Night Always mode. Now JP5 and JP6 can be positioned 1-2, resulting in the total amount of delay, up to 110 microseconds, being made available for equalization.

#### *Delay Equalized Audio*

The delay equalized left and right channel signals, called L\_EQ\_Delay and R\_EQ\_Delay on the schematic, are combined in matrixing amplifiers comprised of sections of U11 and U12. These form the L+Rq (q = quadrature) and L-Rq signals which are used in the CQUAM generator's quadrature modulators. The amount of left and right in each of these signals is adjusted by R65, L+R Null, and R163, L-R Null. The negative peaks of the L+Rq signal are clipped by the negative limiter amp, which is one section of U11, a TL074. The negative limit is adjusted by R143. These signals are then sent to the Quadrature modulators and to front panel switch S2 for metering of L+Rq and L-Rq on the bar graph displays.



### 4.3.2 RF Flow

#### *Pilot Generator*

A QUAM signal contains a 25 Hz pilot tone in the L-R channel. It is produced in the AMS-G1 from Q16, a J309 JFET and Y1, a 25.6 KHz crystal, operating as a Pierce oscillator. This signal is divided by 1024 by U14, a CD4040 ripple counter. This passes through two stages of band-pass filtering in sections of U13, before being summed into the 'Q' modulator U16. Pilot switch S7, is used to turn the pilot on and off by allowing U14 to count or holding it in reset mode. When the pilot is on, the Pilot LED will be illuminated on the front panel.

#### *Carrier Generation*

The carrier frequency of the AMS-G1 is generated in a Colpitts crystal oscillator utilizing Q19 and Y2. The frequency of crystal Y2 is 4 times that of the transmitter carrier frequency. The output of the crystal oscillator is coupled into U22, an MC10131 Johnson counter, which divides the oscillator frequency by four, yielding four outputs at the carrier frequency, at 0, 90, 180, and 270 degrees. The in phase (0 and 180 degree) signals are sent through JP7 and JP8 to one balanced modulator as a push-pull input at the carrier frequency. The quadrature (90 and 270 degree) signals are sent through JP9 and JP10 to the input of the second balanced modulator. The above assumes that jumpers, JP7 thru JP10 are in positions 2-7 and 4-5, bypassing the IQM correction circuitry, as would be the case for a DX series transmitter.

#### *Quadrature Modulation*

The in-phase and quadrature RF carrier components are used to drive U16 and U18, respectively. These are MC1596 balanced modulators. The in-phase modulator is fed the L+Rq signal, and the quadrature modulator is fed the L-Rq and pilot signals. The outputs of the modulators are summed together, to form a phase and amplitude modulated signal. The harmonic energy is then attenuated in the band pass filter comprised of L5 and L6.

#### *Buffer/Limiter*

The low-level quadrature-modulated signal is then amplified in the circuit containing transistors Q14 and Q15. The gain of this amplifier is adjusted by R139, Quam Level. It is then buffered by the Darlington emitter-follower amplifiers comprised of Q5, Q13 and Q11, Q12. This amplified QUAM signal is hard-limited by U10, a MC10116 MECL buffer IC, to remove the amplitude modulation component.

#### *RF Buffer*

The ECL-level RF output from U10 receives an additional stage of amplification through Q8 and Q9. The output of this circuit then drives U8, an SN75123 50 ohm line driver. The output of U8 is a TTL-level RF signal which provides the carrier input to the transmitter, replacing the transmitter's internal oscillator.

### 4.3.3 IQM Correction

Incidental Quadrature Modulation or IQM is a phenomenon produced within the RF power amplifier of a transmitter. Changes in the RF envelope voltage create a change in the non-linear Miller capacitance of the PA MOSFET's, thus creating a phase shift of the carrier waveform, which varies with envelope modulation. It is possible to synthesize this non-linear

phase function from a sample of the PDM modulator output voltage, and use this function to phase-modulate the transmitter's low-level RF carrier signal in such a way as to negate the IQM effects produced in the PA.

When the IQM correction feature of the AMS-G1 is used, it will be necessary to move jumpers JP7, JP8, JP9, and JP10 from the 'DX' to 'SX' positions. This diverts the signal flow of the in-phase and quadrature carrier signals through the IQM-correction, phase modulator circuits, a pair of CA3028A balanced modulators, U17 and U19.

#### *IQM Correction Circuitry Analysis*

A sample of the transmitter's PDM modulator output voltage is input to J1, the 'PDM Sample +' and 'PDM Sample -' terminals. These samples are buffered by two sections of op-amp U15. An LM13600 transconductance amp U9 is used to synthesize the transmitter's IQM curve, with pots R185 and R192 used to set the correction function coefficients. The IQM correction function, present at the emitter of buffer amp Q17, is used to amplitude-modulate the output of U19.

This amplitude-modulated, in-phase carrier signal output of U19 is summed with the constant-amplitude, quadrature-phase carrier signal output of U17 to form a waveform with both amplitude and phase modulation. This waveform is amplified by Q18, and band-pass filtered to remove out-of-band energy before it is hard-limited by LM360 comparator U20. An RC phase shift network generates a quadrature signal, limited and buffered by U21, a second LM360. The results are in-phase and quadrature, TTL-level signals possessing the phase modulation function necessary to correct the transmitter IQM. These signals are fed back to the LM1596 balanced modulators in the QUAM generator circuitry of the AMS-G1.

When operating with Harris Gates or SX transmitters, circuitry is provided to compensate for the IQM intrinsic in these transmitters.

### 4.3.4 Metering Circuitry

Two LED bar-graph meters are featured on the front panel for the display of left/right channel, or L+R/L-R signal amplitudes. Switch S2 controls the metering function of the displays. (The discussion of the operation of the metering circuitry will be made in reference to the left channel circuitry. The right channel circuitry operates analogously.) The audio signal enters the metering board via a buffer, one section of U3. The signal next enters an amplifier, also part of U3, with its gain programmable at either 2 or 20, set by analog switches Q5 and Q6. This allows the gain of the meters to be increased by ten during periods of low audio levels. The audio signal is full-wave rectified by another stage of U3, and peak-detected by Q2, CR-1, and C7. This voltage is buffered by another stage of U3, which drives U7, U8, and U9, three LM3914 bar-graph meter driver IC's. These drive LED displays DS5, DS6, and DS7. Samples of the meter signals are diode OR-ed by CR3 and CR4, with the resulting level compared against reference levels by U4, an LM339 comparator. The outputs of these comparators set the state of the flip-flop comprised of Q7, Q8, Q9 and Q10, which

set the gain of the variable gain amplifiers at either 2 or 20. When the metering amp is in its high-gain mode, the '10X' display is illuminated.

*Monitoring L+Re on the Bar Graph Display*

The L+Re signal can be metered by toggling S1 on the exciter PC board. This removes the L+Rq signal from meter switch S2 and puts the L+Re signal in its place. Now, when S2 is placed in the L+R/L-R position it will be reading L+Re and L-Rq. With S1 in its normal position the display will read L+Rq and L-Rq.

#### **4.3.5 Power Supply**

A shielded toroidal transformer provides voltage for the unit. The transformer has tapped, multiple primaries to allow operation from 100, 120, 200, 220 and 240 volts AC. One secondary is full-wave rectified to provide voltage for the 5 volt supply, and the other secondary is full-wave rectified to provide the plus and minus 15 volt supplies. A capacitive voltage-multiplier using this secondary provides voltage for the 24 volt supply for the LED bar graph displays. Each of the supplies is regulated by either an LM317 or LM337 three-terminal regulator.

## Section V Maintenance/Alignments

This section contains the information and procedures necessary to maintain and align the AMS-G1 AM Stereo exciter. It contains an IQM Correction Alignment procedure, Factory Tune up procedure and preventive and corrective maintenance.

### 5.1 Alignment Procedures

There are three alignment procedures for the exciter:

1. AMS-G1 Setup Procedure - Used to adjust the delay equalization circuits in the exciter for best separation. This procedure is located in the Installation section, since it must be performed when the unit is installed. For this procedure and complete installation instructions, please refer to Section II, Installation/Initial Turn-on.
2. IQM Correction Alignment Procedure - To be performed when the unit is installed with a Gates or SX series transmitter. The procedure is outlined later in this section. This procedure is not required, but will optimize AM stereo separation and reduce the distortion of C-QUAM AM Stereo signals. The AMS-G1 Setup Procedure (delay equalization), in Section II, must be performed after completion of the IQM adjustments.
3. Factory Tune up Procedure - Normally, these adjustments have been performed at the factory, and will not be required to be performed in the field. Do not attempt to adjust any internal controls unless you have a complete understanding of the C-QUAM system and the alignment procedure. The procedure is outlined later in this section, after the IQM procedure.

### 5.2 GATES/SX IQM Correction

This section of the AMS-G1 was designed to correct the Incidental Quadrature Modulation (IQM) present in the Harris Gates and SX transmitters. With this enabled and aligned, the transmitter will exhibit improved channel separation and reduced distortion of C-QUAM AM Stereo signals. For more information on IQM and the IQM correction circuits, refer to Section IV, Overall System Theory.

#### 5.2.1 IQM Correction Alignment Procedure

Equipment needed: Dual-Trace 40 MHz Oscilloscope  
Audio Function Generator  
C-QUAM Stereo Monitor

- a. Disconnect the AC power from the transmitter.
- b. Place the AMS-G1 in its 'STEREO' mode. Verify that the jumpers JP-7, JP-8, JP-9, and JP-10 are in the 'SX' positions. Refer to Figure 2-9.

- c. Apply a +10 dBm, 1 kHz, L-R signal at the Left and Right channel audio inputs of the exciter. Using the oscilloscope, view the 'QUAM' waveform at TP6 on the AMS-G1. Adjust the 'QUAD ADJUST' pot R278 until the peaks of the waveform are of the same amplitude. See Figures 5-1 and 5-2. R278, if misadjusted, can increase stereo distortion.
- d. Obtain a length of shielded, twisted pair audio cable (Belden 8451 or equivalent UL Listed cable) of sufficient length to reach from the transmitter to the AMS-G1. Connect one end of one of the supplied in-line fuse-holder to the rear terminal (back of cabinet) of L-11 on the first PA module. Splice the other end of the fuse-holder to the lead of the cable running to P1-2 (PDM Sample +). Cover the joint with heat-shrink tubing.

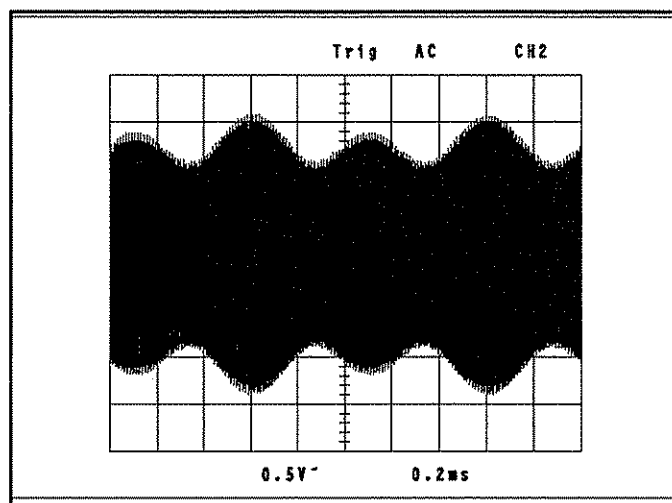

Figure 5-1.  
R278 Misadjusted

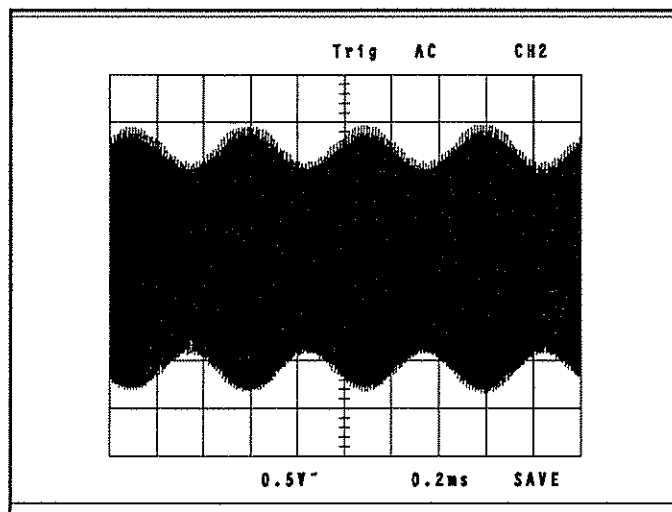

Figure 5-2.  
R278 Properly Adjusted

- e. Connect one end of the second supplied in-line fuse-holder to the cathode terminal (body stripe) of CR13 in the first PA module. Splice the other end of the fuse-holder to the cable running to P1-1 (PDM Sample -). Cover joint with heat-shrink tubing. Install the supplied 1/4 A fuses into the fuse-holders. Dress the shield conductor of the cable so that it can be attached to the ground lug of the exciter. Trim back the shield end of this cable in the transmitter flush with the cable insulation, and cover with heat shrink tubing. Plug P1 into J1 at the rear of the exciter.
- f. Apply a -20 dBm, 1 kHz sine wave signal to the Left and Right audio inputs of the AMS-G1.
- g. Apply AC power to the transmitter by reconnecting the AC power and throwing the breaker at the bottom front of the transmitter.
- h. Connect the oscilloscope to the C-QUAM monitor, observing the 'L-R' demodulated output. Place the C-QUAM monitor in the 'L+R/L-R' metering mode. Connect the C-QUAM monitor's RF input to the transmitter's modulation monitor output.
- i. Switch the transmitter to its nominal full power level. Gradually increase the output of the signal generator until the 'L+R' meter of the C-QUAM monitor reads 30% modulation.
- j. Observing the 'L-R' meter on the C-QUAM monitor, gradually adjust the 'GAIN' pot R267 in the exciter for minimum 'L-R' reading.
- k. Increase the signal generator output until the 'L+R' meter on the monitor indicates 85% modulation. Adjust the 'CURVE 1' and 'CURVE 2' pots R192 and R185 to minimize the reading in the monitor 'L-R' meter. Re-adjust the 'GAIN' pot R267 for minimum 'L-R' reading. Repeat this process until no further reduction can be obtained.
- l. If proper IQM performance (better than 30 Db separation) cannot be achieved in this manner, it may be due to the presence of an earlier IQM correction circuit which is present in some transmitters. This can be verified by the presence of a BNC 'Tee' connector at the rear of the oscillator card cage. If so, short the terminals of the sample transformer toroid TS2, located at the top of the first PA module in the transmitter. Disconnect the BNC cable running from this transformer to the BNC 'Tee' connector at the rear of the oscillator card cage. Repeat the above adjustments.

If this procedure is followed, a 10 to 20 dB reduction in transmitter IQM can be realized.

#### Note

Following this procedure, the AMS-G1 Setup procedure in Section II, Installation/Initial Turn-on, must be performed.

## 5.3 Factory Tune-up Procedure For AMS-G1

Should you believe that exciter mis-alignment has occurred, the following procedure has been provided. The AMS-G1 Setup (delay equalization) procedure will need to be performed when the following adjustments are completed.

### 5.3.1 Audio Matrix and Equalization

All adjustments to be made without equalization and at 1kHz unless specified otherwise.

Set the following switches and controls as follows:

- a. Binary and bulk delays to zero, with S3, S4, S5 and S6 at their 'zero' position, and R75, R69, R82, R87, R259, R266, R271 and R274 fully CCW.
- b. Negative limit control R143 fully CW.
- c. Jumpers JP4, JP7, JP8, JP9, and JP10 in the 'DX' position.
- d. Day/Night mode to 'Day', and the Stereo/Mono mode to 'Stereo'.
- e. Set the front panel Metering Switch to the 'L+R/L-R' position.
- f. Input L+R signal corresponding to 100% modulation, at +10dBm. Adjust R163 for L-R null at TP12. Adjust the meter calibration pot R24 on the display board until the bar graph displays read 100%.
- g. Input L-R signal at 100% modulation. Adjust R65 for L+R null at TP10. Adjust R32 for L+R null at TP4. Adjust the meter calibration pot R67 on the display board until the bar graph displays read 100%.
- h. Input Left only signal at 100% modulation. Adjust R165 until the amplitude of the signal at TP12 equals the amplitude of the signal at TP10.

### 5.3.2 QUAM Modulator Alignment

- a. Check the carrier-frequency crystal and frequency-dependant parts to be sure they are appropriate for the frequency of the unit under test.
- b. Monitoring the RF frequency at J3, SYNC Q REF on the back panel, with a digital frequency counter, set the carrier frequency with C136.
- c. Adjustments are to be made with the 'Pilot' switch in the off position.
- d. Input 120% L+R audio modulation. With the oscilloscope, observe the waveform at TP6 and adjust R197, the quadrature suppression pot, until the envelope crossover points are sharpest. See Figure 5-3.
- e. Reduce audio input for 100% L+R audio modulation. Observe the waveform at TP6 and adjust R189, the Carrier Level pot, until the envelope shows closure at the negative modulation peaks.
- f. Input 10 kHz, 70% modulation, Left only signal, and observe the waveform at TP6. Adjust L5 and L6 for maximum amplitude, and symmetry of depth of trough in the envelope waveform. See Figure 5-4. Repeat test for a Right only signal, and re-adjust L5 and L6 for the best

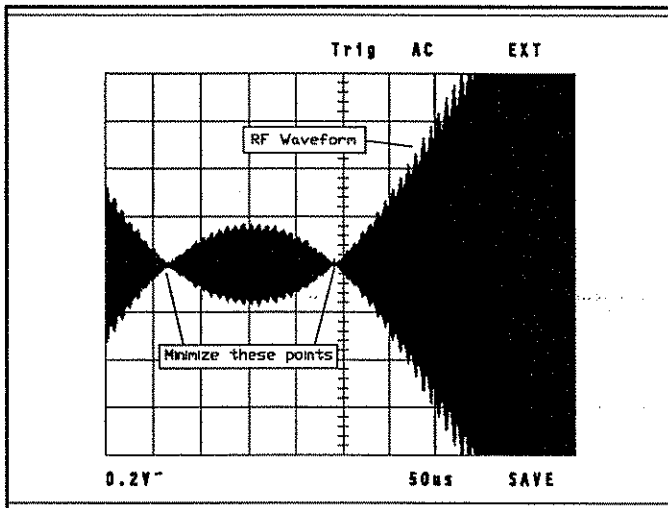

Figure 5-3.

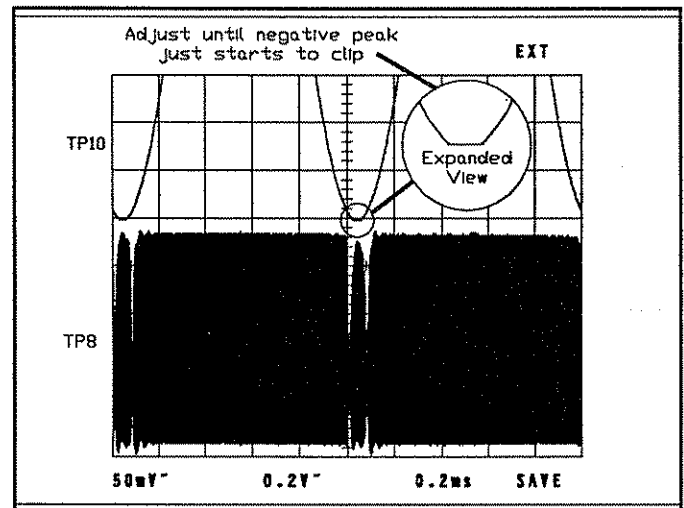

Figure 5-5.

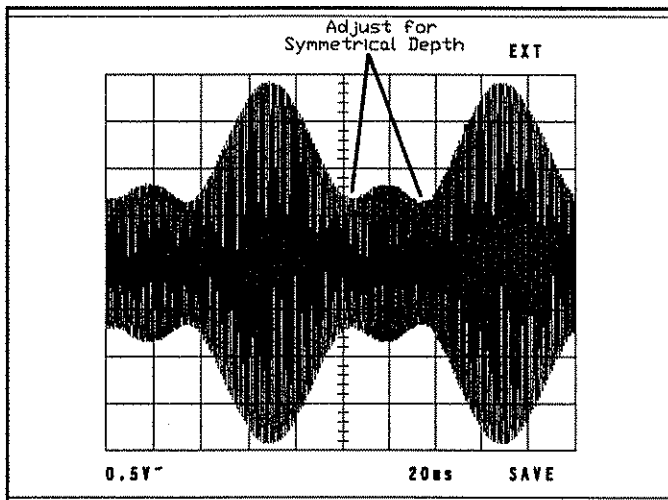

Figure 5-4.

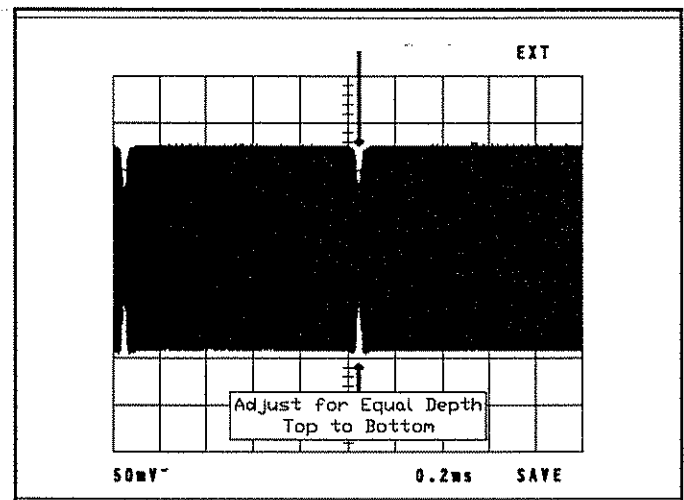

Figure 5-6.

compromise of performance between Left and Right signals.

- g. Input 1 kHz, 100% modulation, L+R audio signal and observe TP6. Adjust R139, QUAM Level, for a 4.00 Vp-p signal.
- h. Increase the audio amplitude to 105% L+R. Observe the waveforms at TP8 and TP10. Adjust R143, Negative Limit control, until the RF waveform at TP8 becomes fuzzy and the negative peak of the audio at TP10 just starts to clip. See Figure 5-5.
- i. While still observing the Limiter Output at TP8, adjust R124, Limiter Balance, until incidental phase is centered. See Figure 5-6.
- j. Using a high impedance probe, measure the signal at TP6 with a spectrum analyzer. Set the analyzer for 1 dB per division, centered on the carrier frequency of the exciter.

Input an audio signal at 1 kHz, 80% modulation L+R. Measure the amplitude of the sidebands with respect to the carrier. Switch

the input signal to L-R. Observe the amplitude of the 1kHz sidebands. They should be of equal amplitude as before. If not, adjust R165 until the sideband amplitudes of the L-R modulated signal equals that of the L+R modulated waveform.

#### Note

If a spectrum analyzer is not accessible, these adjustments may alternately be made with the AMS-G1 connected to an AM transmitter, and monitoring the modulation level with a C-QUAM modulation monitor.

### 5.3.3 Pilot Adjustment

- a. Place the Pilot switch S7 into the 'Pilot On' position.
- b. Using a digital frequency counter, measure the frequency of the pilot tone at TP11 to verify that it is 25 Hz +/- 1.0 Hz. Adjust C106 if necessary to accomplish this.
- c. Using a high-impedance probe, measure the waveform at TP6 on a spectrum analyzer.
- d. Adjust R153, the Pilot Level control, until the 25 Hz sidebands are -32 dB (2.5%) with respect to the carrier.

**Note**

If a spectrum analyzer is not accessible, these adjustments may alternately be made with the AMS-G1 connected to an AM transmitter, and monitoring the Pilot modulation level with a C-QUAM modulation monitor.

- e. Return the Pilot switch S7 to the 'Off' position.

This completes the factory alignment of the AMS-G1 exciter. You may now proceed to the AMS-G1 Set-up Procedure in Section II.

## 5.4 Preventative Maintenance

Preventative maintenance is a systematic series of operations performed periodically on equipment. Because these procedures cannot be applied indiscriminately, specific instructions are necessary. Preventative maintenance consists of six operations: inspecting, feeling, tightening, cleaning, adjusting, and painting.

- a. **INSPECT.** Inspection is the most important maintenance operation because it determines the necessity for the others. Become thoroughly acquainted with normal operating conditions in order to recognize and identify abnormal conditions readily. Inspect for the following:
  1. Overheating, which is indicated by discoloration, bulging of parts, and peculiar odors.
  2. Oxidation
  3. Dirt corrosion, rust, mildew, and fungus growth.
- b. **FEEL.** Use this operation to check parts for overheating. By this means the lack of proper ventilation or the existence of some defect that can be detected and corrected before serious trouble occurs. Become familiar with operating temperatures in order to recognize deviations from the normal range.
- c. **TIGHTEN.** Tighten loose screws, bolts, and nuts. Do not tighten indiscriminately as fittings that are tightened beyond the pressure for which they are designed may be damaged or broken.
- d. **CLEAN.** Clean parts only when inspection shows that it is necessary and only use approved cleaning solvent.
- e. **ADJUST.** Make adjustments only when inspection shows that it is necessary to maintain normal operation.
- f. **PAINT.** Paint surfaces with the original type of paint (using a prime coat if necessary) whenever inspection shows rust, or worn or broken paint film.

## 5.5 Maintenance of Components

The following paragraphs provide information necessary for the maintenance of components.

**TRANSISTORS.** Preventative maintenance of transistors is accomplished by performing the following steps:

- a. Inspect the transistors and surrounding area for dirt as accumulation of dirt or rust could form leakage paths.

- b. Use compressed air to remove dust from the area.

**WARNING**

**ALWAYS WEAR SAFETY GOGGLES WHEN USING COMPRESSED AIR**

- c. Examine all transistors for loose connections or corrosion. Tighten the transistor mounting hardware to no more than 8 inch-pounds. Overtightening the transistor hardware will cause the silicon insulators to curl up on the ends and possibly short through.

**INTEGRATED CIRCUITS.** Preventative maintenance of integrated circuits is accomplished by performing the following steps:

**CAUTION**

**USE CARE TO AVOID THE BUILDUP OF STATIC ELECTRICITY WHEN WORKING AROUND INTEGRATED CIRCUITS.**

- a. Inspect the integrated circuits and surrounding area for dirt as accumulations of dirt or dust could form leakage paths.
- b. Use compressed dry air to remove dust from the area.

**WARNING**

**ALWAYS WEAR SAFETY GOGGLES WHEN USING COMPRESSED AIR.**

**CAPACITORS.** Preventative maintenance of capacitors is accomplished by performing the following steps:

- a. Examine all capacitor terminals for loose connections or corrosion.
- b. Examine the body of each capacitor for swelling, discoloration, or other evidence of breakdown.
- c. Use standard practices to repair poor solder connections with a low wattage soldering iron.
- d. Clean cases and bodies of all capacitors.

**FIXED RESISTORS.** Preventative maintenance of fixed resistors is accomplished by performing the following steps:

- a. When inspecting a chassis, printed circuit board, or discrete component assembly, examine resistors for dirt or signs of overheating. Discolored, cracked, or chipped components indicate a possible overload.
- b. When replacing a resistor, ensure that the replacement value corresponds to the component value on the schematic diagram and parts list.
- c. Clean dirty resistors with a small brush.

**VARIABLE RESISTORS.** Preventative maintenance of variable resistors is accomplished by performing the following steps:

- a. Clean component with a dry brush or a lint-free cloth.
- b. When dirt is difficult to remove, clean component with a lint-free cloth moistened with an approved cleaning solvent.

**FUSES.** Preventative maintenance is accomplished by performing the following steps:

- a. When a fuse blows, determine the cause before installing a replacement.

**WARNING**

**ENSURE THAT AN EXACT REPLACEMENT FUSE IS USED A DIFFERENT MANUFACTURER'S FUSE OF THE SAME SIZE AND/OR RATING DOES NOT FULFILL THE REQUIREMENT FOR EXACT REPLACEMENT.**

- b. Inspect fuse caps and mounts for charring and corrosion.
- c. Examine clips for dirt, and, if necessary, clean with a small brush.
- d. If necessary, tighten fuse clips and connections to the clips. The tension of the fuse clips may be increased by pressing the clip sides closer together.

**SWITCHES.** Preventative maintenance of switches is accomplished by performing the following steps:

- a. Inspect the switch for defective mechanical action or looseness of mounting and connections.
- b. Operate the switch to determine if they move freely and are positive in action.

**PRINTED CIRCUIT BOARDS.** Preventative maintenance of printed circuit boards is accomplished by performing the following steps:

- a. Inspect the printed circuit board for cracks or breaks.
- b. Inspect the wiring for open circuits or a raised foil.
- c. Check components for breakage or discoloration due to over heating.
- d. Clean off dust and dirt with a clean, dry lint-free cloth.
- e. Use standard practices to repair poor solder connections with a 40 watt soldering iron.





## 6.1 Introduction

This section contains basic troubleshooting information for the exciter. This section will be broken up into three parts:

- Power Supply
- Audio
- RF

For the Audio and RF sections, use of the Functional Block Diagram, Drawing #839-8138-105, will be very helpful in understanding and troubleshooting the signal flow of the exciter.

## 6.2 Power Supply Troubleshooting

Any time a problem with the exciter is suspected, it is a good idea to check the power supplies first. There are five separate regulated supplies all located on the motherboard. All five are simple 3 pin integrated regulators which are easily replaced in case of failure. The supplies can be checked at the following points:

+24V at the anode of CR44	Regulator U31
+15V at TP17	Regulator U28
-15V at TP18	Regulator U29
+5V at TP19	Regulator U30
-5V at the cathode of CR38	Regulator U27

If any of the above voltages are not present, then troubleshoot the regulator and its associated components.

## 6.3 Audio Troubleshooting

The audio portion of the exciter is very simple op-amp circuitry, and therefore should be quick and easy to troubleshoot. To further simplify things, the exciter must have a +10dBm audio input. This means that all of the audio test points will have exactly the same amplitude waveform when the proper audio signal is applied, such as L+R or L-R. A plot of the proper waveform is shown in Figure 6-1. This waveform will be present at the following test points when a L+R signal is applied to the exciter at +10dBm.

TP1 - Right audio input

TP3 - Left audio input

TP4 - L+Re

TP5 - Delayed L+Re (for DX series transmitters)

When in Stereo Mode, it will also be present at the following:

TP13 - Left Delay Equalized audio

TP14 - Right Delay Equalized Audio

TP10 - L+Rq (matrixed L+R for C-QUAM modulator)

By changing the input signal to L-R, the same waveform will also be present at TP12 - L-Rq (matrixed L-R for C-QUAM modulator).

### 6.3.1 No L+R Audio to the Transmitter

If the transmitter will not modulate, then the L+Re or monaural audio has been interrupted. To find out where the signal has been lost, apply a +10dBm, L+R signal to the exciter and refer to the flow chart in Figure 6-2. These signals should be present in either mono or stereo mode.

#### Note

*Be sure to check for proper phasing of the balanced inputs and outputs. For example, with L+R applied to the exciter, TP1 and TP3 should be in-phase with each other. If not, cabling is usually the problem.*

### 6.3.2 Loss of L+R or L-R

The front panel meters on the exciter, when in the L+R/L-R mode are displaying the L+Rq and L-Rq signals from TP10 and TP12 respectively. If either one of these signals is missing, then troubleshooting is a simple matter of tracing signal back to TP1 and TP3 to find where the signal was lost.

#### Check TP1 and TP3

To check the audio at TP1 and TP3, simply set the front panel switch to read Left and Right. Input a +10dBm, L+R signal. Both meters should read 50%. If not, see the chart in Figure 6-2.

#### Check K1

Next, we need to know if K1 is working, and activated for stereo mode. Place a jumper between J4-3 and J4-4, right on the back of the exciter. If K1 is closing, for stereo mode, the front panel indicator will illuminate. You should be able to hear the clicking of K1. To be sure K1 is working, check JP6 pin 3 and JP5 pin 3 (you may have to remove the jumper to do this). The waveforms at these two test points should match the one in Figure 6-1. If no audio is present then replace K1.

#### Checking the Day Mode, Delay Equalization Circuitry

To check the Left EQ delay circuits, look at TP13. The waveform should match the one in Figure 6-1. If not, the problem is either in U4, U5 or S3. U4 can be bypassed altogether by moving S3 (accessible from the left side of the unit) to position 0, or pointing straight up. Note the position of S3 before moving it so it can be put back in its original position after troubleshooting. To check the Right EQ delay circuits, look at TP14. It should match Figure 6-1. If not, troubleshoot U6, U7 and S4.

#### Checking the Night Mode, Delay Equalization Circuitry

To check the Left and Right Night EQ delay circuits, you will still look at TP13 and TP14, but the unit must be placed in the Night Mode. This can be done by placing a jumper on the back of the unit from J4-1 to J4-2, or by moving JP3 to position 2-3. In either case you should hear K2 click. If the jumper on the back illuminates the front panel LED, but does not activate K2, then replace K2.

To make sure K2 is working, remove JP6 while looking at TP13, or JP5 while looking at TP14. If K2 is working, the audio should disappear.

If audio is present in Day Mode, at TP13 and TP14, but not present when switched to Night Mode, then troubleshoot the Left delay circuitry, U23, U24 and S5 or the Right delay circuitry, U25, U26 and S6, whichever is appropriate. Be sure to replace all jumpers and switches to their original positions.

#### *Audio Matrix Check*

The only thing left at this point between the front panel display and Test points 13 and 14, is U11, U12 and the switches S1 and S2. S1 should be in the L+Rq position and is located on the motherboard. Check TP10, the waveform should match Figure 6-1. If not, replace U11 and U12. If it is okay, then change the input signal to L-R at +10dBm and check TP12. It should also match Figure 6-1. If not, replace U11 and U12.

## 6.4 RF Troubleshooting

### 6.4.1 Underdrive

Since the exciter is now the RF source for the transmitter, the most likely RF fault will be UNDERDRIVE. If an underdrive condition is detected by the transmitter we need to know if the problem is in the exciter or the transmitter. The easiest way to find this out is to return the transmitter back to its internal oscillator. For instructions on how to do this refer to the transmitter manual. If the underdrive condition still exists then the problem is in the transmitter, not the exciter.

#### 6.4.1.1 Check the RF Output Cable

If the underdrive goes away then the first thing to do is to remove the External RF input cable from the transmitter end and put it into an oscilloscope. There should be about 4Vp-p at this point. If not then proceed to the next step.

#### 6.4.1.2 QUAM REF Output is okay

Run a cable from the QUAM REF BNC output to the scope. This should be a 2Vp-p CW signal with no audio input, or a 4Vp-p modulated envelope with a +10dBm L+R signal input. If the QUAM REF output is not okay then proceed to step 4.

#### *Checking U8*

If the QUAM REF output is okay, you will need to take the top cover off the exciter. Check TP7, it should be about 4Vp-p. If not, then check U8 pin 5. This should be about 6Vp-p. If so, then replace U8. If U8 is okay then proceed to the next step.

#### *Checking Q8 and Q9*

Next check TP8, it should be about 200mVp-p. If it is, then the problem is most likely Q8 and/or Q9. The signal at the base of Q8 and Q9 (center pin) should read about 300mVp-p.

#### *Checking U10*

If TP8 is not okay, check U10 pins 12 and 13. They should both be about 1.5Vp-p. If so, replace U10.

### 6.4.1.3 QUAM REF Output is Not Okay

If the QUAM REF output is not okay then check TP6. This should be a 2Vp-p CW signal with no audio input or a 4Vp-p modulated envelope signal with a +10dBm L+R audio input. If this signal is not present then it will be best to go all the way back to the oscillator and work our way forward to TP6.

#### *Checking the Oscillator*

The oscillator output will vary with frequency. It is usually about 300 to 400mVp-p at the input to U22, pin 9. If not, troubleshoot the oscillator, keeping in mind that it is operating at 4 times the carrier frequency.

#### *Check U22 and Jumpers JP7 - JP10*

If the oscillator output is okay then check the four outputs from U22. These should be about 800mVp-p and at the carrier frequency. If not, replace U22. If these outputs are okay, then the next place to look would be the input to the balanced modulators, U16 and U18. Both of these should have about 250mVp-p carrier input to pins 8 and 10. If any of these are missing the problem is most likely one of the jumpers JP7, JP8, JP9, and JP10 or an associated resistor.

#### *Gates or SX Transmitters Only*

If the unit is operating with a Gates or SX series transmitter and the IQM Correction circuitry is being used, place the jumpers in the DX position. This will effectively bypass the IQM Correction circuitry and send the output of U22 directly to the input of U16 and U18. If the signal now returns at TP6 then you will need to troubleshoot the IQM Correction circuitry which is detailed later in this section.

#### *Check U16 and U18*

If the inputs to U16 and U18 are okay, then check the outputs at pins 6 and 12 of each IC. This should be about a 100 to 200 mVp-p CW signal with no audio input. If not replace U16 and U18. The outputs of these two IC's are tied together so it would be better to replace both if a problem is suspected with either one of them.

#### *Check the Differential Amplifiers*

If the output of the modulators is okay but TP6 is still missing then troubleshoot Q5 and Q11 - Q15. The signal at the base of Q14 and Q15 should be about 50mVp-p while the signal at the base of Q5 and Q11 should be about 1.5Vp-p.

### 6.4.1.4 IQM Correction Circuitry

The first thing to do here is to check TP15 and TP16. Both of these should have about a 3Vp-p CW signal at the carrier frequency. The two test points should also have a 90 degree phase relationship. If these signals are okay the the problem is most likely the jumpers, JP7 - JP10. If TP15 and/or TP16 have no signal then proceed to the next step.

#### *Check U20 and U21*

U20 and U21 are balanced line drivers. Pin 5 of both IC's should have about 2 to 2.5Vp-p of carrier frequency CW signal. If so, replace U20 and/or U21. If this signal is missing, check Q18.

#### *Checking Q18, U17 and U19*

Q18 should have about 250mVp-p at both the base and emitter and about 4Vp-p at the collector. If either the base or the emitter signal is missing, then either U17 and/or U19 has failed or is not

getting an input signal. It is also possible for Q18 to have failed and be loading down the outputs of U17 and U19. Troubleshoot accordingly.

The rest of the circuitry, Q10, Q17, U15 and U9 should not have any effect on RF drive, but could show up as a problem when performing the IQM Correction Alignment Procedure.

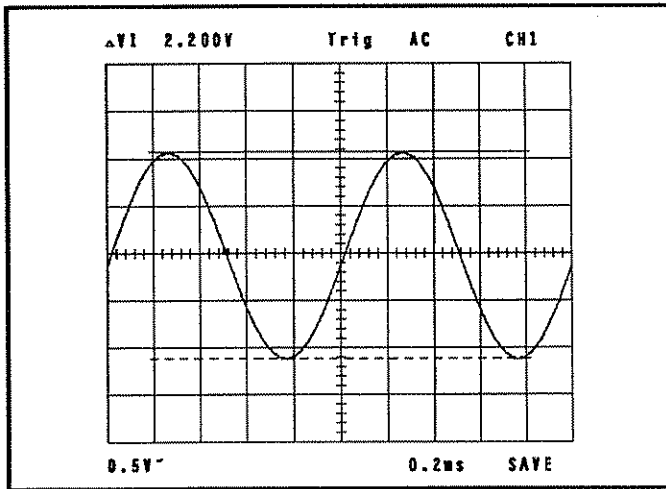

Figure 6-1. L+R @ 10dBm Waveform

## NO AUDIO (L+R) TO TRANSMITTER

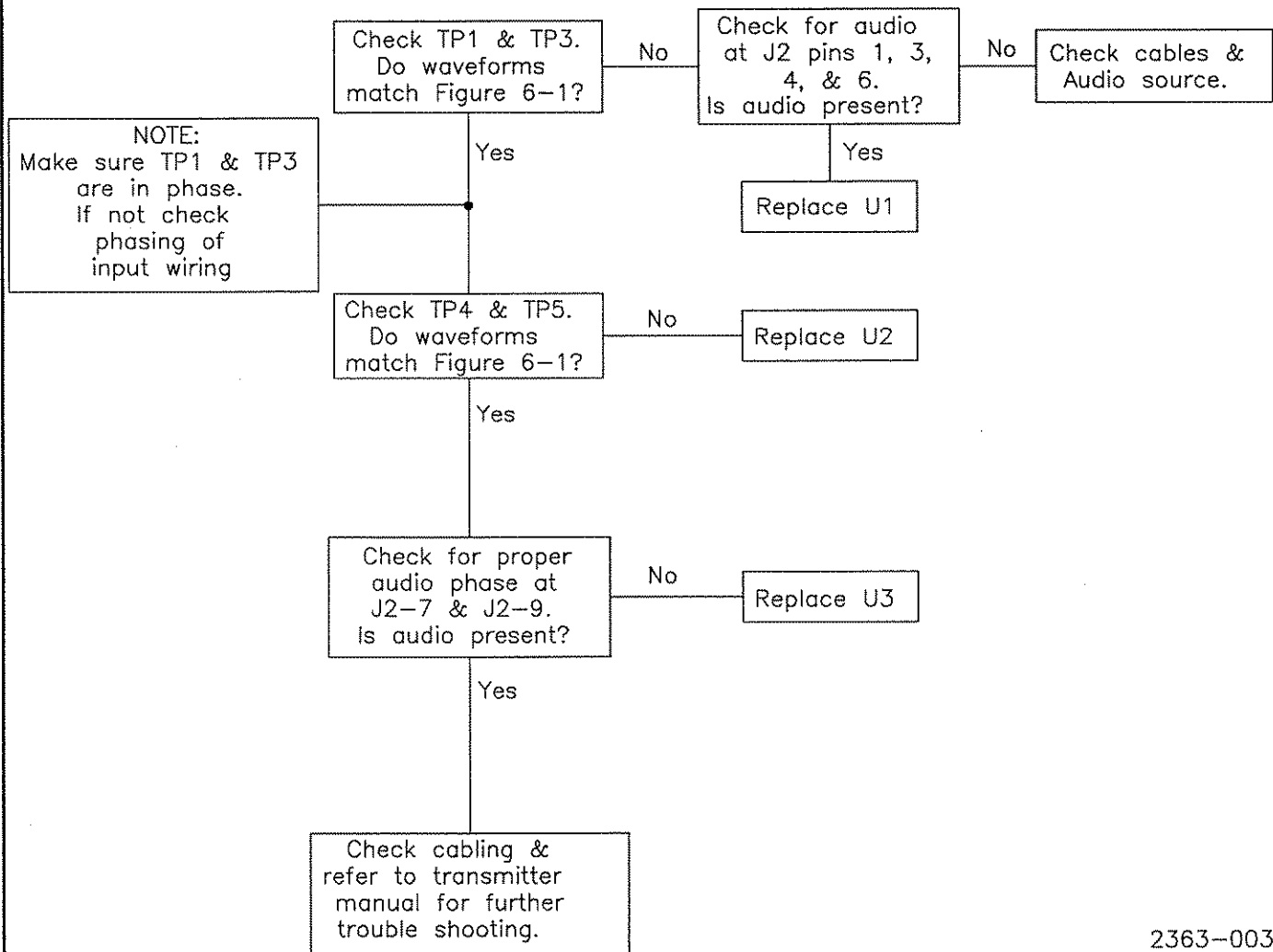

Figure 6-2. Troubleshooting Flow Chart for L+R  
Monaural Audio Path. Signal Input is L+R @ 10dBm

# Section VIA Emergency Operating Procedure

## 6.1 AMS-G1 Emergency Operating Procedure

In the unlikely event of a total system failure of the AMS-G1, the unit must be bypassed. To complete the bypassing procedure do the following:

- Remove primary power to the transmitter, and the AMS-G1.
- Remove audio frequency output, AF OUT +, AF OUT -, and the shield from pins 7, 8 and 9 on connector J2 at the rear of the unit.
- If a monaural matrixing system is not available (suggested system illustrated in figure 3-2) the choice of either run-

ning right channel or left channel audio from the audio source must be made at this time. Connect the audio cable removed from step 1 to either the left or right channel output of the audio source. Disconnect the remaining channel from the AMS-G1 to prevent damage to the audio source due to a possible short circuit.

- Disconnect the RF output J5 at the rear of the unit.
- The transmitter must be returned to its internal oscillator mode. **REFER TO YOUR TRANSMITTER MANUAL'S PROCEDURE FOR RETURNING TO INTERNAL OSCILLATOR MODE.**
- Return primary power to the transmitter

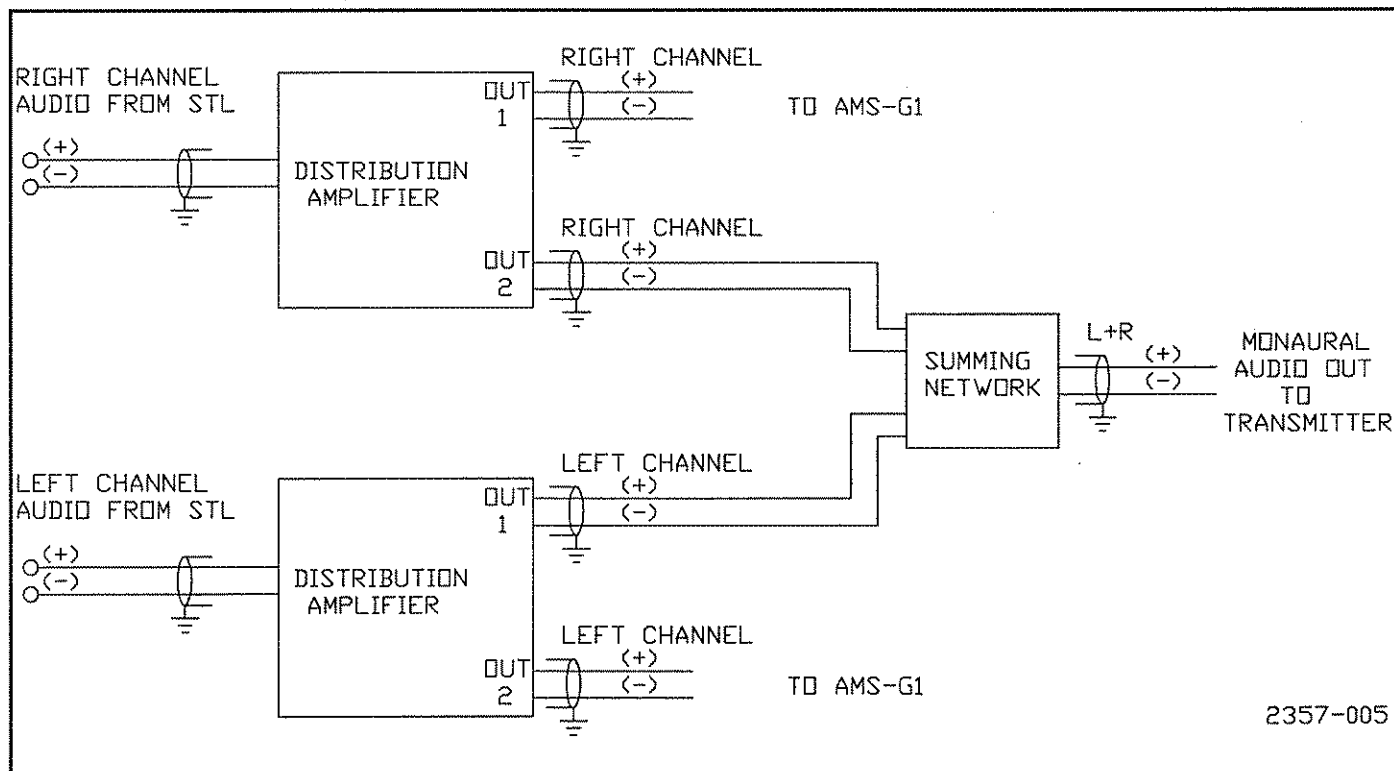

Figure 6A-1. AMS-G1 Emergency Audio Bypass



# Section VII Replaceable Parts List

**Table 7-1. STEREO GENERATOR AMS-G1 - 994 9480 001**

HARRIS P/N	DESCRIPTION	QTY/UM	REF. SYMBOLS/EXPLANATIONS
000 0000 010	B/M NOTE: .....	0	THE TAG ON THE REAR OF THIS UNIT TO BE MARKED WITH THE VOLTAGE THAT THE AMS-G1 IS CONFIGURED
398 0011 000	FUSE,FAST CART .250A 250V .....	2	
402 0165 000	FUSEHOLDER, IN-LINE .....	2	
492 0819 000	COIL, 75-150UH Q60 .....	0	A1L5 A1L6
492 0820 000	COIL, 190-340UH QMIN=50 .....	0	A1L5 A1L6
494 0196 000	CHOKE RF 100UH .....	0	A1L7B
494 0405 000	CHOKE RF 56.0UH .....	0	A1L9C
494 0406 000	CHOKE RF 68.0UH .....	0	A1L7C
494 0407 000	CHOKE RF 82.0UH .....	0	A1L9B
494 0409 000	CHOKE RF 150.0UH .....	0	A1L7A A1L9A
494 0411 000	CHOKE RF 220.0UH .....	0	A1L10B
494 0413 000	CHOKE RF 330.0UH .....	0	A1L8C A1L10A
494 0415 000	CHOKE RF 470.0UH .....	0	A1L8B
494 0416 000	CHOKE RF 560.0UH .....	0	A1L8A
500 0753 000	CAP 56PF 500V 5% .....	0	A1C171B A1C178B
500 0754 000	CAP 220PF 500V 5% .....	0	A1C168C
500 0756 000	CAP 330PF 500V 5% .....	0	A1C168B
500 0759 000	CAP 100PF 500V 5% .....	0	A1C171A A1C178A
500 0761 000	CAP 150PF 500V 5% .....	0	A1C89
500 0784 000	CAP 300PF 500V 5% .....	0	A1C116B
500 0787 000	CAP 200PF 500V 5% .....	0	A1C116C
500 0814 000	CAP 36PF 500V 5% .....	0	A1C89
500 0815 000	CAP 39PF 500V 5% .....	0	A1C171C A1C178C
500 0816 000	CAP 43PF 500V 5% .....	0	A1C163C
500 0819 000	CAP 51PF 500V 5% .....	0	A1C82
500 0820 000	CAP 62PF 500V 5% .....	0	A1C163B
500 0821 000	CAP 68PF 500V 5% CM05 .....	0	A1C89
500 0822 000	CAP 75PF 500V 5% .....	0	A1C82
500 0823 000	CAP 82PF 500V 5% .....	0	A1C82
500 0825 000	CAP 110PF 500V 5% .....	0	A1C163A
500 0826 000	CAP 120PF 500V 5% .....	0	A1C89
500 0827 000	CAP 130PF 500V 5% .....	0	A1C82 A1C89
500 0828 000	CAP 160PF 500V 5% .....	0	A1C82
500 0833 000	CAP 390PF 500V 5% .....	0	A1C116A
500 0834 000	CAP 430PF 500V 5% .....	0	A1C168A
500 0840 000	CAP, MICA 680PF 300V 5% .....	0	A1C88
500 0841 000	CAP, MICA 750PF 300V 5% .....	0	A1C88
500 0878 000	CAP 1500PF 500V 5% .....	0	A1C88
500 0887 000	CAP 2200PF 500V 5% .....	0	A1C88
500 0913 000	CAP 1200PF 500V 5% .....	0	A1C88
500 1164 000	CAP 1800PF 500V 5% .....	0	A1C88
540 0888 000	RES 100 OHM 1/4W 5% .....	0	A1R137 A1R140

540 0894 000.....	RES 180.0 OHM 1/4W 5% .....	0	A1R137 A1R140
540 0896 000.....	RES 220.0 OHM 1/4W 5% .....	0	A1R137 A1R140
540 0898 000.....	RES 270.0 OHM 1/4W 5% .....	0	A1R137 A1R140
548 1124 000.....	RES 2.21K OHM 1/4W 1% .....	0	A1R127 A1R128
548 1289 000.....	RES 1.21K OHM 1/4W 1% .....	0	A1R127 A1R128
732 0512 000.....	VIDEO,INSTALLATION AMS-G1.....	1	
817 2374 003.....	SPEC, XTAL, FOR AMS-G1 .....	0	
817 2374 008.....	SPEC, TEST, AMS-G1 .....	0	
839 8138 103.....	WIRING DIAG, OVERALL .....	0	
839 8138 104.....	FD CHART, AMS-G1 .....	0	
988 2363 001.....	DP, AMS-G1 .....	1	
990 1131 001.....	R-SC KIT AMS-G1 .....	0	
994 9480 002.....	STEREO GENERATOR AMS-G1 .....	1	
994 9517 001.....	R-SP KIT AMS-G1 .....	0	

**Table 7-2. STEREO GENERATOR AMS-G1 - 994 9480 002**

HARRIS P/N	DESCRIPTION	QTY/UM	REF. SYMBOLS/EXPLANATIONS
250 0274 000.....	CORD, POWER 3C 7-1/2 FT .....	1	
296 0258 000.....	TUBING TEFLON 19AWG .....	.75 FT	#FL001
296 0261 000.....	TUBING, SHRINK 1/8 WHITE .....	.4 FT	#FL001
296 0262 000.....	TUBING, SHRINK 1/4 WHITE .....	.1 FT	#FL001
354 0613 000.....	CONTACT SOCKET 26-18 AWG .....	5	#FL001
398 0040 000.....	FUSE,SLOW CART .125A 250V .....	1	F001
398 0045 000.....	FUSE,SLOW CART .250A 250V .....	1	F001
402 0020 000.....	CLIP, FUSE .....	2	#F001
472 1732 000.....	TRANSFORMER, AM SG .....	1	T001
484 0296 000.....	* FILTER RFI POWER LINE .....	1	FL001
560 0049 000.....	MOV 4500A 75J 275VAC .....	3	RV001 RV002 RV003
610 0001 000.....	RECP 2 CONTACT MALE .....	1	J001
612 0095 000.....	RECP 2 CONT FEMALE .....	1	#J001
612 1362 000.....	RECP 6C 1ROW STRAIGHT .....	1	A1J1
612 1407 000.....	RECP, 9C 1 ROW .....	1	#J002
612 1408 000.....	RECP, 4C 1 ROW .....	1	#J004
646 0569 000.....	LABEL 814-2939-001 .....	2	
646 0665 000.....	INSPECTION LABEL .....	1	
646 1255 000.....	LABEL H-141 .....	1	
646 1455 000.....	LABEL, XMITTING EQUIPMENT.....	1	
646 1510 000.....	OVERLAY, AMS-G1 FRT PNL .....	1	
813 4999 022.....	STDOFF 6-32X1/4 1/4 HEX .....	6	
917 2106 001.....	TAG, INPUT AC VOLTAGE .....	1	THIS TAG TO BE ATTACHED TO THE REAR PANEL
917 2374 005.....	RIBBON CABLE .....	1	
917 2374 006.....	JUMPERS, STEREO GENERATOR .....	1	
922 1228 002.....	HIGH VOLTAGE COVER .....	1	
922 1228 004.....	AC COVER .....	1	
943 5429 104.....	CHASSIS .....	1	
943 5429 105.....	FRONT PANEL .....	1	
943 5429 106.....	REAR PANEL .....	1	
943 5429 107.....	TOP, STEREO GENERATOR .....	1	
992 8845 001.....	PWB, STEREO GENERATOR .....	1	A001
992 8846 001.....	DISPLAY PWB .....	1	A002



Table 7-3. PWB, STEREO GENERATOR - 992 8845 001

HARRIS P/N	DESCRIPTION	QTY/UM	REF. SYMBOLS/EXPLANATIONS
254 0002 000	WIRE, BUS CU 20AWG	0.040 FT	#Y001
335 0262 000	DF137A INSULATING WASHER	4.0 EA	#U028 #U029 #U030 #U031
354 0309 000	TERM SOLDER	23.0 EA	E001 E002 TP001 TP002 TP003 TP004 TP005 TP006 TP007 TP008 TP009 TP010 TP011 TP012 TP013 TP014 TP015 TP016 TP017 TP018 TP019 TP020 TP021
358 3402 000	STDOFF PWB .143 ID X .50	4.0 EA	
380 0189 000	XSTR, NPN 2N3904 ESD	7.0 EA	Q003 Q004 Q005 Q006 Q011 Q014 Q015
380 0190 000	XSTR, PNP 2N3906 ESD	10.0 EA	Q001 Q002 Q007 Q008 Q009 Q010 Q012 Q013 Q017 Q018
380 0573 000	XSTR, J309 ESD	2.0 EA	Q016 Q019
382 0019 000	IC, 3028B ESD	2.0 EA	U017 U019
382 0333 000	IC, MC1496 ANALOG MULT/SQUARER	2.0 EA	U016 U018
382 0467 000	IC, MC10116L ESD	1.0 EA	U010
382 0555 000	IC CD4040/MC14040 ESD	1.0 EA	U014
382 0594 000	IC TL074ACN ESD	6.0 EA	U001 U002 U011 U012 U013 U015
382 0690 000	IC 10131 ESD	1.0 EA	U022
382 0744 000	* IC, SE5514N ESD	8.0 EA	U004 U005 U006 U007 U023 U024 U025 U026
382 0746 000	IC, 79L05AC ESD	1.0 EA	U027
382 0749 000	IC NE5532A ESD	1.0 EA	U003
382 1127 000	IC ADJ VOLT REG ESD	3.0 EA	U028 U030 U031
382 1186 000	IC, NEG., VOLT REG. 1.5A, ESD	1.0 EA	U029
382 1340 000	IC, 13600 ESD	1.0 EA	U009
382 1363 000	IC, SN75123 ESD	1.0 EA	U008
382 1427 000	IC LM360N ESD	2.0 EA	U020 U021
384 0205 000	DIODE SILICON 1N914/4148 ESD	19.0 EA	CR001 CR006 CR010 CR011 CR020 CR021 CR022 CR023 CR024 CR025 CR026 CR027 CR028 CR031 CR032 CR033 CR045 CR046 CR047
384 0321 000	DIODE 5082-2800/1N5711 ESD	5.0 EA	CR012 CR014 CR015 CR018 CR019
384 0357 000	RECTIFIER 1N4004 ESD	15.0 EA	CR013 CR016 CR029 CR030 CR034 CR035 CR036 CR037 CR038 CR039 CR040 CR041 CR042 CR043 CR044
384 0748 000	TRANSORB, BIPOLAR 90V ESD	4.0 EA	CR003 CR005 CR009 CR017
384 0799 000	DIODE, BIPOLAR ESD	4.0 EA	CR002 CR004 CR007 CR008
404 0267 000	SOCKET, CRYSTAL HC-13/U	1.0 EA	XY002
404 0673 000	SOCKET 8 PIN DIP (DL)	3.0 EA	XU003 #U020 #U021
404 0674 000	SOCKET 14 PIN DIP (D-L)	16.0 EA	XU001 XU002 XU004 XU005 XU006 XU007 XU011 XU012 XU013 XU015 XU016 XU018 XU023 XU024 XU025 XU026
404 0675 000	SOCKET IC 16 CONT	5.0 EA	XU008 XU009 XU010 XU014 XU022
410 0419 000	INSULATOR PAD FOR TO-247	4.0 EA	#U028 #U029 #U030 #U031
444 2993 000	CRYSTAL, 25.600 KHZ	1.0 EA	Y001
478 0425 000	XFMR, RF T2.5-6T	1.0 EA	T001
494 0419 000	IND 1000UH 10%	4.0 EA	L001 L002 L003 L004
500 0755 000	CAP 270PF 500V 5%	4.0 EA	C023 C066 C068 C099
500 0759 000	CAP 100PF 500V 5%	2.0 EA	C120 C122
500 0807 000	CAP 18PF 500V 5%	1.0 EA	C109
500 0810 000	CAP 24PF 500V 5%	2.0 EA	C107 C134
500 0813 000	CAP 33PF 500V 5%	2.0 EA	C095 C133
500 0829 000	CAP 180PF 500V 5%	2.0 EA	C138 C139
500 0832 000	CAP 360PF 500V 5%	1.0 EA	C162
500 0833 000	CAP 390PF 500V 5%	4.0 EA	C040 C062 C157 C184
500 0835 000	CAP, MICA 470PF 500V 5%	4.0 EA	C041 C064 C158 C175
500 0957 000	CAP 7PF 500V +/-5PF	2.0 EA	C112 C113
506 0230 000	CAP .001UF 100VAC 5%	25.0 EA	C001 C002 C003 C004

506 0232 000..... CAP .01UF 100V 5% ..... 4.0 EA  
506 0233 000..... CAP .1UF 63V 5% ..... 5.0 EA  
506 0234 000..... CAP .0022UF 100V 5% ..... 4.0 EA  
506 0237 000..... CAP .0068UF 100V 5% ..... 21.0 EA

516 0085 000..... CAP DISC .03UF 600V ..... 2.0 EA  
516 0453 000..... CAP .1UF 100V 20BEC7R ..... 71.0 EA

516 0509 000..... CAP 2.2UF 50V 10BEC7R ..... 1.0 EA  
516 0530 000..... CAP .01UF 10% 100V X7R ..... 7.0 EA  
516 0936 000..... CAP 0.018UF 10% 50V ..... 21.0 EA

518 0102 000..... CAP VAR 5-25PF 100V ..... 1.0 EA  
518 0105 000..... CAP VAR 2.5-9PF 100V ..... 1.0 EA  
522 0541 000..... CAP 220UF 50V 20% ..... 2.0 EA

522 0548 000..... CAP 10UF 50V 20% ..... 5.0 EA  
522 0550 000..... CAP 100UF 25V 20% ..... 6.0 EA  
522 0565 000..... CAP 2200UF 63V 20% ..... 2.0 EA  
522 0568 000..... CAPACITOR 6800 MFD 50V ..... 3.0 EA  
548 2400 101..... RES 10 OHM 1/2W 1% ..... 2.0 EA  
548 2400 134..... RES 22.1 OHM 1/2W 1% ..... 10.0 EA  
548 2400 151..... RES 33.2 OHM 1/2W 1% ..... 1.0 EA  
548 2400 169..... RES 51.1 OHM 1/2W 1% ..... 1.0 EA  
548 2400 173..... RES 56.2 OHM 1/2W 1% ..... 6.0 EA  
548 2400 201..... RES 100 OHM 1/2W 1% ..... 14.0 EA

548 2400 209..... RES 121 OHM 1/2W 1% ..... 4.0 EA  
548 2400 230..... RES 200 OHM 1/2W 1% ..... 1.0 EA  
548 2400 234..... RES 221 OHM 1/2W 1% ..... 4.0 EA  
548 2400 242..... RES 267 OHM 1/2W 1% ..... 4.0 EA  
548 2400 247..... RES 301 OHM 1/2W 1% ..... 18.0 EA

548 2400 251..... RES 332 OHM 1/2W 1% ..... 4.0 EA  
548 2400 255..... RES 365 OHM 1/2W 1% ..... 1.0 EA  
548 2400 266..... RES 475 OHM 1/2W 1% ..... 5.0 EA  
548 2400 268..... RES 499 OHM 1/2W 1% ..... 2.0 EA  
548 2400 269..... RES 511 OHM 1/2W 1% ..... 2.0 EA  
548 2400 276..... RES 604 OHM 1/2W 1% ..... 14.0 EA

548 2400 277..... RES 619 OHM 1/2W 1% ..... 3.0 EA  
548 2400 281..... RES 681 OHM 1/2W 1% ..... 12.0 EA  
548 2400 285..... RES 750 OHM 1/2W 1% ..... 2.0 EA  
548 2400 289..... RES 825 OHM 1/2W 1% ..... 2.0 EA  
548 2400 301..... RES 1K OHM 1/2W 1% ..... 24.0 EA

C010 C018 C020 C028 C029 C034 C046 C047 C054 C055 C060 C142  
C148 C165 C174 C194 C196 C198 C199 C201 C202  
C035 C059 C154 C182  
C096 C100 C104 C105 C108  
C037 C058 C155 C179  
C009 C024 C025 C031  
C032 C039 C042 C043 C048 C049 C063 C147 C151 C159 C160 C161  
C169 C195 C197 C200 C203  
C110 C111  
C005 C006 C007 C008 C011 C014 C015 C016 C022 C026 C036 C038  
C050 C051 C056 C057 C065 C067 C069 C070 C071 C072 C073  
C074 C075 C076 C084 C090 C092 C094 C097 C098 C101 C102 C103  
C114 C115 C117 C118 C119 C121 C123 C124 C125 C126 C127 C128  
C129 C130 C131 C132 C135 C145 C146 C152 C153 C167 C170 C176  
C177 C180 C183 C204 C205 C206 C207 C208 C209 C210  
C212 C213  
C093  
C017 C078 C080 C081 C085 C086 C087  
C013 C019 C021 C027 C030 C033 C044 C045 C052 C053 C061 C143  
C144 C149 C150 C156 C164 C166 C172 C173 C181  
C136  
C106  
C077  
C079  
C137 C185 C188 C190 C211  
C012 C083 C091 C187 C189 C192  
C140 C141  
C186 C191 C193  
R042 R126  
R116 R118 R224 R225 R229 R231 R232 R233 R234 R235  
R214  
R142  
R120 R121 R222 R223 R226 R227  
R020 R024 R040 R111 R113 R135 R148 R160 R207 R209 R243 R245  
R246 R247  
R287 R300 R301 R302  
R276  
R196 R199 R241 R242  
R093 R098 R099 R115  
R017 R018 R058 R059 R064 R089 R091 R092 R220 R221 R228 R230  
R257 R258 R280 R282 R294 R299  
R162 R237 R239 R303  
R285  
R062 R112 R201 R210 R213  
R106 R107  
R188 R190  
R001  
R002 R050 R052 R055 R068 R071 R073 R252 R253 R254 R260 R264  
R265  
R100 R101 R110  
R019 R037 R081 R085 R094 R097 R114 R130 R149 R150 R155 R156  
R122 R125  
R203 R208  
R013 R025 R027 R029

548 2400 309	RES 1.21K OHM 1/2W 1%	40.0 EA	R031 R033 R041 R070 R086 R095 R096 R104 R109 R119 R123 R131 R133 R136 R175 R202 R204 R240 R262 R272 R043 R044 R045 R046 R048 R049 R051 R053 R056 R067 R072 R076 R077 R078 R079 R080 R083 R084 R138 R141 R216 R219 R249 R250 R251 R261 R263 R268 R269 R270 R288 R289 R290 R291 R292 R293 R295 R296 R297 R298 R283 R284 R129 R132 R034 R035 R184 R218 R273 R275 R281 R286 R060 R090 R187 R256 R277 R145 R147 R038 R134 R205 R215 R212 R206 R211 R161 R151 R173 R054 R152 R026 R028 R157 R166 R057 R088 R255 R279 R191 R061 R066 R074 R164 R003 R004 R005 R006 R007 R008 R009 R010 R011 R012 R014 R015 R016 R023 R146 R154 R169 R171 R172 R186 R193 R194 R198 R238 R248 R103 R181 R182 R036 R039 R183 R217 R021 R022 R195 R200 R105 R108 R180 R236 R030 R117 R102 R144 R159 R168 R176 R177 R178 R179 R158 R167 R047 R244 R170 R174 R153 R278 R065 R143 R163 R165 R189 R124 R032 R139 R197 R267 R185 R192 R075 R087 R266 R274 R063 R069 R082 R259 R271 K001 K002 S003 S004 S005 S006 S001 S007
548 2400 313	RES 1.33K OHM 1/2W 1%	2.0 EA	
548 2400 318	RES 1.5K OHM 1/2W 1%	2.0 EA	
548 2400 330	RES 2K OHM 1/2W 1%	7.0 EA	
548 2400 335	RES 2.26K OHM 1/2W 1%	1.0 EA	
548 2400 342	RES 2.67K OHM 1/2W 1%	5.0 EA	
548 2400 343	RES 2.74K OHM 1/2W 1%	2.0 EA	
548 2400 347	RES 3.01K OHM 1/2W 1%	1.0 EA	
548 2400 351	RES 3.32K OHM 1/2W 1%	3.0 EA	
548 2400 354	RES 3.57K OHM 1/2W 1%	1.0 EA	
548 2400 361	RES 4.22K OHM 1/2W 1%	2.0 EA	
548 2400 364	RES 4.53K OHM 1/2W 1%	1.0 EA	
548 2400 366	RES 4.75K OHM 1/2W 1%	2.0 EA	
548 2400 368	RES 4.99K OHM 1/2W 1%	2.0 EA	
548 2400 369	RES 5.11K OHM 1/2W 1%	4.0 EA	
548 2400 376	RES 6.04K OHM 1/2W 1%	4.0 EA	
548 2400 389	RES 8.25K OHM 1/2W 1%	1.0 EA	
548 2400 395	RES 9.53K OHM 1/2W 1%	4.0 EA	
548 2400 401	RES 10K OHM 1/2W 1%	25.0 EA	
548 2400 418	RES 15K OHM 1/2W 1%	3.0 EA	
548 2400 426	RES 18.2K OHM 1/2W 1%	2.0 EA	
548 2400 430	RES 20K OHM 1/2W 1%	2.0 EA	
548 2400 433	RES 21.5K OHM 1/2W 1%	2.0 EA	
548 2400 434	RES 22.1K OHM 1/2W 1%	2.0 EA	
548 2400 447	RES 30.1K OHM 1/2W 1%	2.0 EA	
548 2400 458	RES 39.2K OHM 1/2W 1%	1.0 EA	
548 2400 467	RES 48.7K OHM 1/2W 1%	1.0 EA	
548 2400 469	RES 51.1K OHM 1/2W 1%	2.0 EA	
548 2400 501	RES 100K OHM 1/2W 1%	2.0 EA	
548 2400 558	RES 392K OHM 1/2W 1%	2.0 EA	
548 2400 569	RES 511K OHM 1/2W 1%	4.0 EA	
548 2400 589	RES 825K OHM 1/2W 1%	2.0 EA	
548 2400 601	RES 1MEG OHM 1/2W 1%	2.0 EA	
548 2400 634	RES 2.21MEG OHM 1/2W 1%	2.0 EA	
550 0858 000	POT 5K OHM .5W 10%	2.0 EA	
550 0947 000	POT 1K OHM 1/2W 10%	5.0 EA	
550 0949 000	POT 100K OHM 1/2W 10%	1.0 EA	
550 0957 000	POT 500 OHM 1/2 W 10%	4.0 EA	
550 0959 000	POT 20K OHM 1/2 W 10%	1.0 EA	
550 0961 000	POT 50K OHM 1/2W 10%	1.0 EA	
550 0967 000	POT 10K 1/2W/.3W 10%	4.0 EA	
550 1035 000	POT 5K OHM 1/2W 10%	5.0 EA	
574 0497 000	RELAY 2PDT 24VDC 2AMP	2.0 EA	
600 0579 000	SW, ROTARY 4PDT	4.0 EA	
604 0748 000	SW, TGL 2 POS	2.0 EA	

604 1148 000.....	SW, VERTICAL ROCKER DPDT .....	1.0 EA	S002
610 0747 000.....	HEADER ASSY 26 PIN .....	1.0 EA	P006
610 0900 000.....	HEADER 3 CKT STRAIGHT .....	6.0 EA	JP001 JP002 JP003 JP004 JP005 JP006
610 0981 000.....	HDR 20C 2ROW VERTICAL .....	1.0 EA	J008
610 1110 000.....	HDR 8C 2R STRT UNPOL .....	4.0 EA	JP007 JP008 JP009 JP010
610 1145 000.....	HDR, 6PIN, 1ROW, STRT,POL .....	1.0 EA	J001
610 1179 000.....	HDR 9C 1 ROW 90 DEG .....	1.0 EA	J002
610 1180 000.....	HDR 4C 1 ROW 90 DEG .....	1.0 EA	J004
612 1184 000.....	JUMPER .1" CENTERS .....	14.0 EA	1/XJP01 1/XJP02 1/XJP03 1/XJP04 1/XJP05 1/XJP06 2/XJP07 2/XJP08 2/XJP09 2/XJP10
612 1268 000.....	RECEPTACLE RT ANG BNC .....	3.0 EA	J003 J005 J007
612 1308 000.....	RECEPTACLE 26 PIN VER PC .....	1.0 EA	J006
839 8138 002.....	SCHEM, STEREO GENERATOR .....	0.0 EA	
843 5429 002.....	PWB, STEREO GENERATOR .....	1.0 EA	
917 2374 002.....	REG HEAT SINK .....	1.0 EA	#U028 #U029 #U030 #U031
917 2374 004.....	RF CHOKE .....	4.0 EA	RFC001 RFC002 RFC003 RFC004
999 2771 001.....	HARDWARE LIST, STEREO GEN .....	1.0 EA	

Table 7-4. DISPLAY PWB - 992 8846 001

HARRIS P/N	DESCRIPTION	QTY/UM	REF. SYMBOLS/EXPLANATIONS
380 0189 000	XSTR, NPN 2N3904	4	Q001 Q002 Q011 Q012
380 0726 000	XSTR, 2N7000 ESD	8	Q005 Q006 Q007 Q008 Q009 Q010 Q015 Q016
382 0594 000	IC TL074ACN ESD	2	U002 U003
382 0648 000	IC, LM339A	1	U004
382 1008 000	IC, LM3914N	6	U007 U008 U009 U012 U013 U014
382 1127 000	IC ADJ VOLT REG ESD	2	U001 U010
384 0321 000	DIODE 5082-2800/1N5711	10	CR001 CR002 CR003 CR004 CR005 CR006 CR007 CR008 CR009 CR010
384 0847 000	LED 10 SEG BARGRAPH, GRN	4	DS005 DS006 DS008 DS009
384 0849 000	LED LIGHT BAR, GREEN	4	DS001 DS002 DS003 DS004
384 0893 000	LED 10 SEG BARGRAPH, RED	2	DS007 DS010
404 0674 000	SOCKET 14 PIN DIP (D-L)	3	XU002 XU003 XU004
404 0747 000	SOCKET STRIP 16 POS	1	
404 0766 000	SOCKET 18 PIN DIP (DL)	6	XU007 XU008 XU009 XU012 XU013 XU014
404 0827 000	SOCKET, DIP20, LO PROFILE	6	XDS005 XDS006 XDS007 XDS008 XDS009 XDS010
516 0453 000	CAP .1UF 100V 20% X7R	14	C001 C002 C003 C005 C006 C008 C012 C013 C014 C016 C027 C028 C029 C030
516 0530 000	CAP .01UF 10% 100V X7R	2	C004 C015
516 0765 000	CAP 10PF 5% 100V C0G	8	C010 C011 C018 C019 C021 C025 C032 C033
522 0573 000	CAP 47UF 50V 20%	2	C026 C031
522 0578 000	CAP 1UF 20% 50 VDC	2	C007 C017
522 0580 000	CAP 100UF 20% .35V NP	2	C009 C020
540 0896 000	RES 220.0 OHM 1/4W 5%	2	R027 R028
540 1001 000	RES 5.1M OHM 1/4W 5%	2	R011 R054
540 1375 000	RES NETWORK 1000 OHM 2%	6	R072 R073 R074 R075 R076 R077
548 0473 000	RES 10 OHM 1/4W 1%	2	R009 R052
548 1093 000	RES 5.11K OHM 1/4W 1%	2	R010 R053
548 1098 000	RES 100 OHM 1/4W 1%	1	R034
548 1102 000	RES 1.5K OHM 1/4W 1%	2	R037 R081
548 1114 000	RES 499 OHM 1/4W 1%	6	R002 R003 R004 R045 R046 R047
548 1115 000	RES 332 OHM 1/4W 1%	2	R086 R087
548 1121 000	RES 10K OHM 1/4W 1%	6	R012 R025 R026 R032 R036 R070
548 1130 000	RES 267 OHM 1/4W 1%	2	R008 R051
548 1139 000	RES 20K OHM 1/4W 1%	2	R013 R019
548 1148 000	RES 100K OHM 1/4W 1%	7	R014 R015 R016 R033 R057 R058 R059
548 1170 000	RES 200K OHM 1/4W 1%	3	R023 R030 R066
548 1279 000	RES 301 OHM 1/4W 1%	4	R082 R083 R084 R085
548 1289 000	RES 1.21K OHM 1/4W 1%	6	R001 R005 R006 R044 R048 R049
548 1476 000	RES 210K OHM 1/4W 1%	4	R020 R022 R063 R065
548 1537 000	RES 4.22K OHM 1/4W 1%	1	R035
548 2069 000	RES 49.9K OHM 1/4W 1%	2	R017 R018
548 2117 000	RES 11K OHM 1/4W 1%	2	R021 R064
548 2121 000	RES 121 OHM 1/4W 1%	2	R007 R050
548 2168 000	RES 9.76K OHM 1/4W 1%	1	R031
550 0970 000	POT 1K OHM 1/2W 10%	2	R024 R067
610 0933 000	JUMPER, PWB TEST POINT	1	TP001
610 0981 000	HDR 20C 2ROW VERTICAL	1	J001
839 8138 003	SCHEM, DISPLAY	0	
843 5429 003	PWB, DISPLAY	1	

01-31-95

888-2363-001

7-7

**WARNING: Disconnect primary power prior to servicing.**









# Introduction to the Motorola C-QUAM AM Stereo System

## WHAT IS C-QUAM?

C-Quam is a system using amplitude modulation for the main (L + R) signal, and a quadrature type of phase modulation for the stereo information. Quadrature combines two signals at a phase angle of 90 degrees for transmission, and then at the receiver separates them again. It is another form of multiplexing. This technique is used to transmit the color information in the U.S. TV color system and is used for encoding of SQ and QS quadraphonic records. In the application to AM stereo, quadrature is really transmitting two AM signals on the same channel. For relatively narrow bandwidth applications such as we have with AM radio, AM is really the most efficient emission because amplitude modulation requires the minimum bandwidth and it is independent of noise. What this means is that in an AM receiver, the effective background noise remains the same with or without modulation. This is not so with FM or PM, which under modulation, "kicks up" additional noise not present under no modulation conditions. So in AM quadrature, an additional channel can be created and heavily modulated without "kicking up" excessive noise. In other words, for narrow bandwidth communications systems, there is a signal to noise advantage to using AM quadrature.

Another important point for AM stereo is the long transmission path from the transmitter, through a directional antenna, over a difficult propagation path, and through a narrow bandwidth and possibly mistuned receiver, is a very rough one. In order to be demodulated with the least distortion and maintaining separation, the signal must be very resilient . . . able to withstand the difficult transmission experience. This also is best done with AM quadrature because two of the same type of signals are being transmitted and therefore undergo the same type of distortions which can in many instances be canceled at the other end. In other words, for AM stereo the differences between the two signals must be preserved, and if each undergoes the identical distortions during transmission, the differences between the two signals will be maintained. This is another reason why the AM/PM and AM/FM stereo systems are not very good because distortions to the AM component are very different from the distortions to the PM or FM component during transmission, and the result is a much more distorted AM stereo signal.

Although many have tried to use AM quadrature for AM stereo, the most difficulty is encountered when modifications are made to make it compatible with envelope detectors in existing AM radios. The Motorola scientists and engineers found a way of taking advantage of the quadrature characteristics, while transmitting a compatible AM component.

## THE NATURE OF AM AND FM SIDEBANDS

In order to describe the system, some basics must be understood about certain types of modulation and how it is detected or not detected. To check our understanding, let's look at two basic types of transmission, AM and FM, modulated by a very low distortion sine wave.

When a signal is amplitude modulated by a sine wave, we can describe it in several ways. One is to simply look at the amplitude and trace it vs. time. This would be the typical display on an oscilloscope of the R.F. envelope. See Figure 1. Another is to look at it on a spectrum analyzer which would show three vertical lines, in the center, a taller line representing the carrier, and the two sidebands, lesser in amplitude, shown on either side of the carrier. In these two representations, there is no phase information given but for now think of the two sidebands as being in-phase sidebands or "I" sidebands. Thus in a perfect AM signal with no distortion there are no higher order sidebands or harmonics of the primary AM sidebands and there is no net phase modulation of the total of the carrier and the two sidebands.

The other case, FM (or PM) is where the phase or frequency is modulated according to our low distortion sine wave, and let's say the deviation is at least a few kHz. In this case, the R.F. envelope does not vary and the A.C. output of the envelope detector would be zero. The spectrum, however, would usually consist of a component at the carrier frequency and a family of sidebands located at multiples of the modulating frequency away from the carrier. For instance if the carrier frequency was 1000 kHz, and the modulation was 1 kHz, there would be symmetrical sidebands at 999, 1001 and at multiples of 1 kHz that are significant.

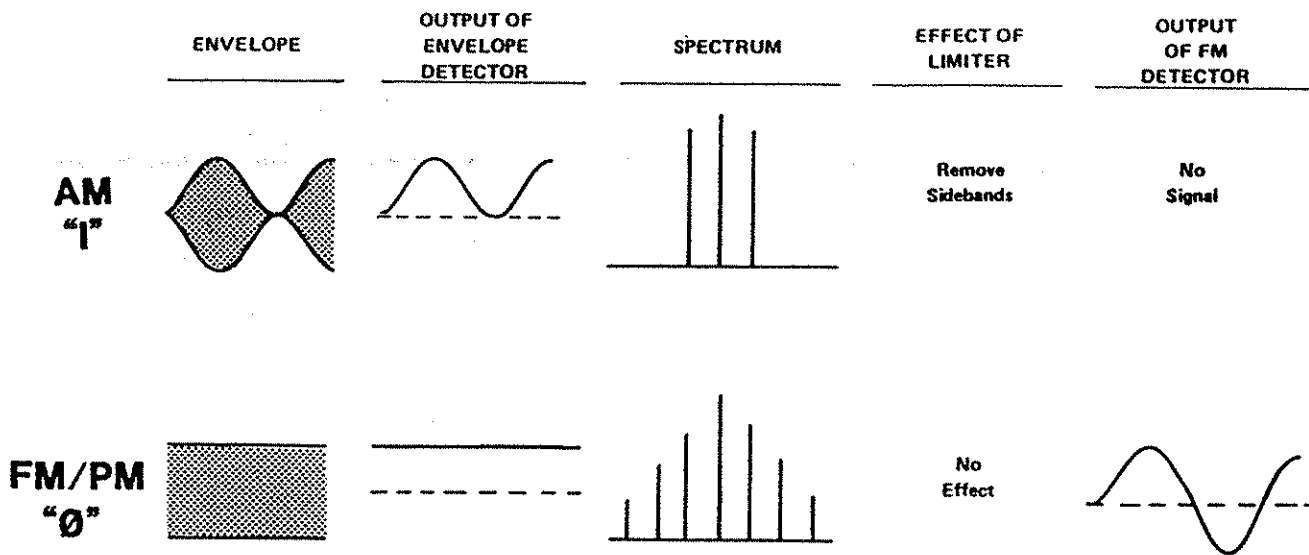

Figure 1.

If there is a carrier and sidebands, why doesn't the envelope detector detect the modulation? The reason is that in FM and PM, the instantaneous phase and amplitude of the carrier component and all the sidebands always add up to the same power as the unmodulated carrier. As the modulation is turned up, the carrier is reduced in amplitude and the missing carrier power is given to the sidebands, but the sum total at all times remains the same. It is the phasing of the sidebands that determines whether they will add and subtract with the carrier to produce differences in amplitude or whether they will add and subtract with the carrier component to always give the same amplitude. In the case of FM or PM, let's call the sidebands phase or "Ø" ( $\phi$ ) sidebands.

Now, the interesting thing is that "Ø" sidebands don't need a linear amplifier to be amplified and can be crunched to death by limiters and class C amplifiers and the same spectrum still comes out the other end. On the other hand "1" sidebands must have linear amplification in order to survive and can be totally stripped from the signal by a good limiter. An envelope detector will be blind to the existence of perfect PM or FM sidebands, and a phase or frequency demodulator will not see perfect "1" sidebands or amplitude modulation.

Another interesting fact is that all modulation can be represented by a combination of the "1" sideband components and the "Ø" sideband components. This is very important in AM stereo broadcasting because it is necessary to split any of the AM stereo system's signals into the "1" and "Ø" signals for transmission on an existing AM transmitter. See Figure 2. For all systems, the "1" signal is given to the transmitter in audio form at the audio input to the transmitter and then it amplitude modulates the signal in the normal way recreating an AM or an "1" sideband signal. For all systems, the "Ø" components are fed to the transmitter in R.F. form as a phase modulated signal that replaces the crystal oscillator in the transmitter. Of course the "Ø" signal sidebands can pass through the intermediate and final amplifier R.F. stages of the transmitter even though these stages are non linear and usually operate class C. The Motorola AM stereo system also required that it be reconstructed for such transmission but certain modifications are made for compatibility with the millions of existing AM radios.

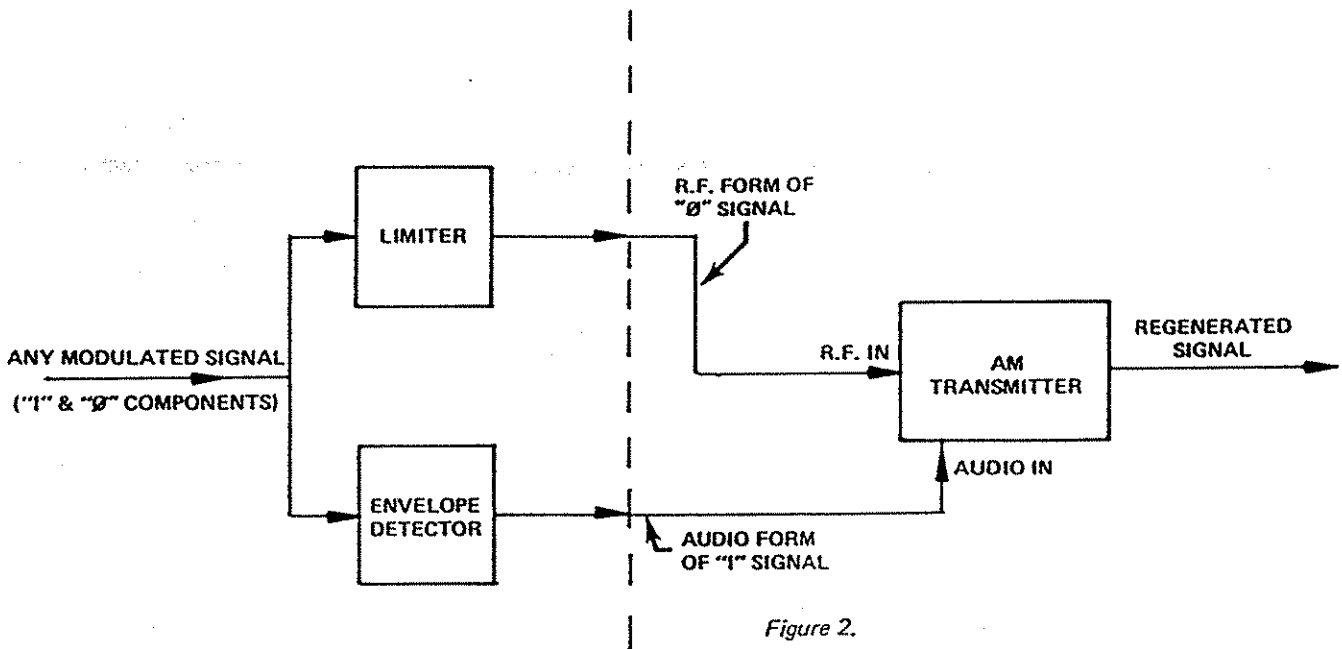

Figure 2.

### PURE QUADRATURE

Observe Figure 3. Pure AM-AM quadrature can be generated by two transmitters connected so that their outputs add. One transmitter would be a standard AM generator producing the carrier at, let's say, zero phase, and sidebands associated with that carrier ("I" sidebands). A second transmitter is fed from the same master oscillator as the AM transmitter, but the phase is shifted 90 degrees. Because we already have a full carrier at zero degrees phase from the AM transmitter providing a phase reference for the receiver, the second transmitter does not need a carrier and is set up with a balanced modulator canceling out the carrier and producing only sidebands. Because these sidebands are generated from a carrier which is 90 degrees out of phase from the AM transmitter, these sidebands will be 90 degrees out of phase with the AM sidebands and "in quadrature." These become our "Q" sidebands.

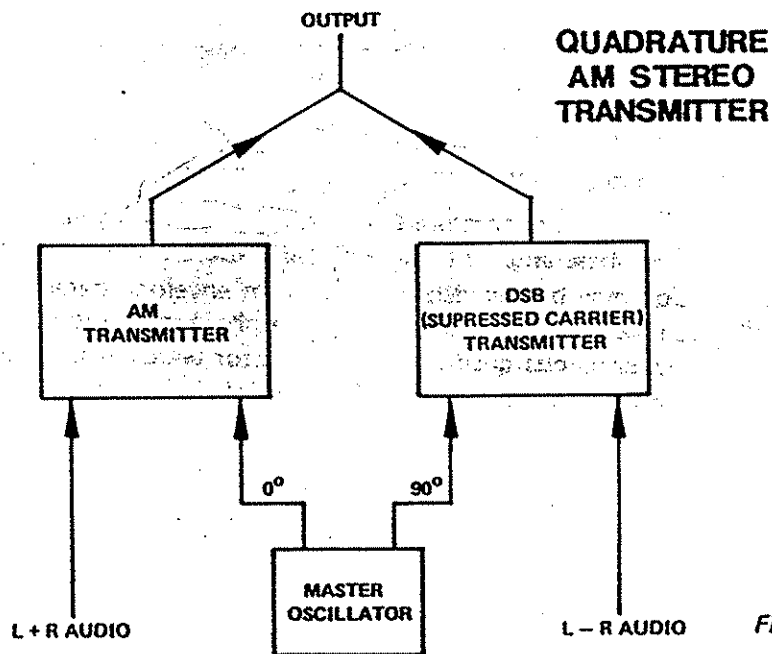

Figure 3.

If we wanted to make an AM stereo system we could transmit  $L + R$  into the AM transmitter, and  $L - R$  into the double sideband transmitter. Sounds good, but under left or right only conditions where both transmitters are contributing sidebands to the output, the resultant would be a distorted AM signal. Before we look at why, let's take a look at a quadrature demodulator which is also the widely touted synchronous detector.

## THE QUADRATURE (SYNCHRONOUS) DETECTOR

To recover the audio signals separately at the receiver, a system of phase detectors is arranged. See Figure 4. First, a reference phase must be derived from the transmitted signal. This is the reference carrier which is generated by means of a phase locked loop (PLL).

The device that is primarily responsible for the operation of the synchronous detector is the balanced demodulator or product detector. When this device is given an input signal and a reference carrier, it will provide at its output the difference of the two signals. If the two signals are identical in frequency and 90 degrees out of phase, the output will be zero. If there is a constant difference in phase it will give a D.C. output or if the phase is varying it will give an A.C. output. The D.C. output of the "Q" detector is fed back to a voltage controlled oscillator (VCO) which causes the frequency and phase of that oscillator to zero in on the input carrier frequency and phase and then lock to it.

This provides the phase reference for the "I" and "Q" detectors. The A.C. output from the "I" demodulator provides the original  $L + R$  audio from the AM transmitter, but it does not see the "Q" sidebands from the double sideband transmitter. The second demodulator is also fed from the VCO but its carrier reference signal is automatically shifted 90 degrees. Therefore it sees the "Q" sidebands from the double sideband transmitter and sees nothing from the AM transmitter input audio which is  $L + R$ .

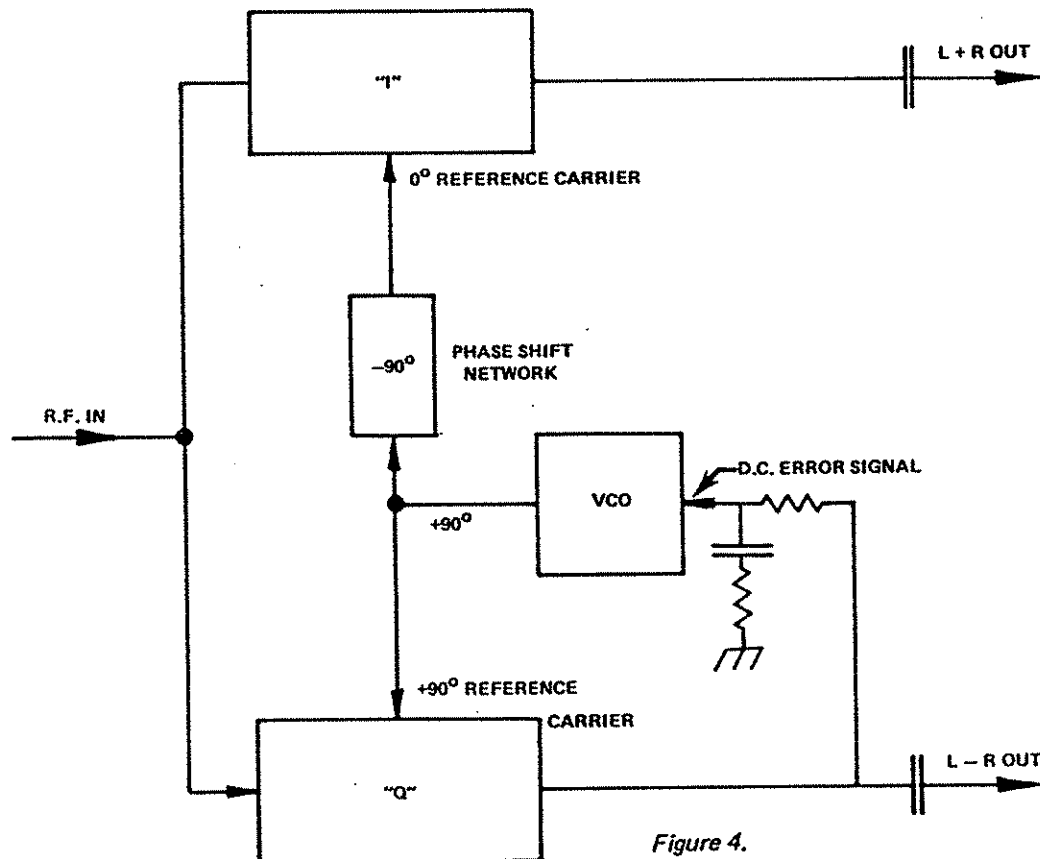

Figure 4.

The AM-AM quadrature system would be excellent for AM stereo except that the envelope detectors in normal AM radios don't see only the "I" sidebands or the "Q" sidebands but see the simple vector addition of both. The envelope detector is not capable of seeing any phase information and only sees the RMS total of the modulation and carrier regardless of phase.

Under  $L + R$  ( $L = R$ ) only modulation conditions (monaural), there is no problem, because only the AM transmitter is modulated and the envelope detector recovers AM perfectly. (The double sideband stereo transmitter receives no audio because when  $L = R$ ,  $L - R = 0$ .) However, under stereo conditions, for instance, when  $L$  only is transmitted, full sideband components are contributed by both the AM and double sideband transmitters and the envelope looks like Figure 5. This would not be compatible with existing envelope detector receivers and a very distorted signal would be heard.

### QUADRATURE MODULATION ENVELOPES

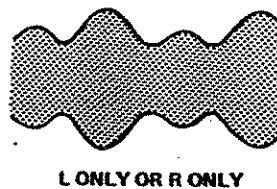
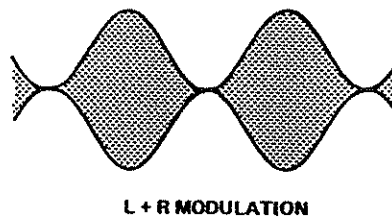

Figure 5.

### COMPATIBLE QUADRATURE

The Motorola AM stereo system is not complicated at all. It simply takes a pure quadrature signal as just described, and extracts the phase modulation components of the quadrature signal and phase modulates the broadcast transmitter. At the same time it sends  $L + R$  audio to the audio input of the transmitter as usual. That's it! The advantage is that a very nice AM signal is always transmitted so that the envelope detectors are compatible, but that the phase modulation of the carrier is derived from a pure quadrature modulation. The result is a signal with most of the advantages of quadrature modulation while maintaining all important monaural compatibility.

## THE C-QUAM ENCODER

The C-Quam encoder is diagramed in Figure 6. Note that pure quadrature is generated by taking  $L + R$  and  $L - R$  and modulating two balanced modulators fed with R.F. signals out of phase by 90 degrees. In this case the 90 degrees phase shift is derived by using a Johnson counter which divides an input frequency (four times station carrier frequency) by four and automatically provides digital signals precisely 90 degrees out of phase for the balanced modulators. The carrier is inserted directly from the Johnson counter. At the output of the summing network, the result is a pure quadrature AM stereo signal. From there it is passed through a limiter which strips the incompatible AM components from the signal and leaves only the phase modulation "Q" sidebands. This is not the same as the simple output of the "Q" modulator because the addition of the "I" and "Q" balanced modulators produced some phase shifting not present in the "Q" modulator alone. The output of the limiter is amplified and sent to the broadcast transmitter in place of the crystal oscillator.

The left and right audio signals are precisely added and sent to the audio input terminals of the broadcast transmitter.

That's the essence of the Motorola C-Quam encoder.

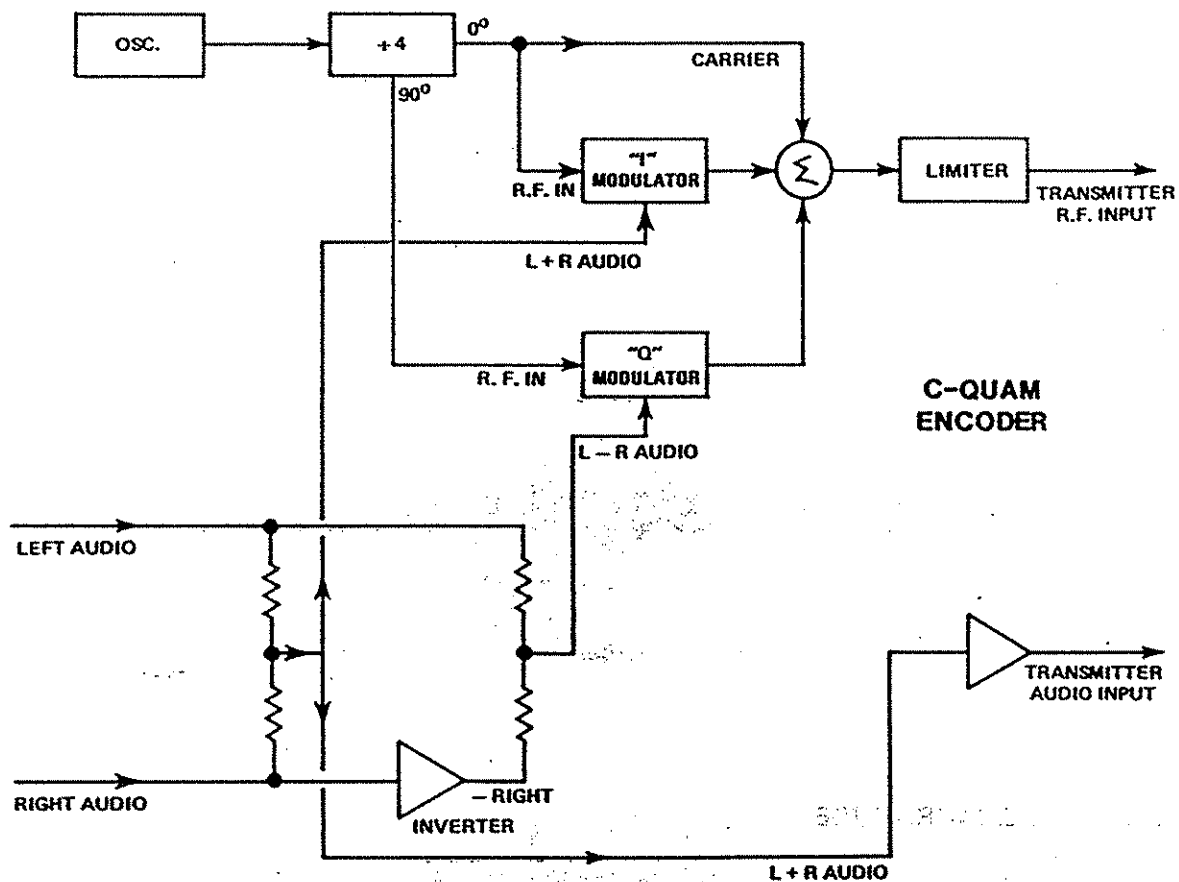

Figure 6.

## DECODING C-QUAM

C-Quam is decoded by simply converting the broadcast signal which is already "almost" quadrature to quadrature and then using a quadrature detector to extract  $L - R$ . Refer to Figure 7. Note that the demodulator contains a section which is the pure quadrature demodulator as previously described. In order to prepare the broadcast signal for the quadrature demodulator, it has to be converted from the envelope detector compatible signal which is broadcast to the original quadrature

signal that was not envelope detector compatible. This is done by demodulating the broadcast signal two ways; with an envelope detector, and with an "I" detector. The two signals are compared and the resultant error signal is used to gain modulate the input of the "I" and "Q" demodulators.

When the transmitted signal is  $L + R$  (monaural, no stereo) the transmitted signal is pure AM or only "I" sidebands. In this case the envelope detector and the "I" demodulator see the same thing. There is no error signal, the gain modulator does nothing and the signal passes through without change. However, when a left or right only signal is transmitted, both AM and PM is transmitted and the input signal is shifted in phase to the "I" demodulator and loses some of its "I" amplitude. The envelope detector sees no difference in the AM because of the phase modulation, and when the envelope detector and the "I" demodulator are compared, there is an error signal. The error signal AGC's the input level to the detector. This action makes the input signal to the "I" and "Q" demodulators look like a pure quadrature signal and the "Q" audio output gives a perfect  $L - R$  signal. The demodulator output is combined with the envelope detector output in a matrix to give left and right audio outputs.

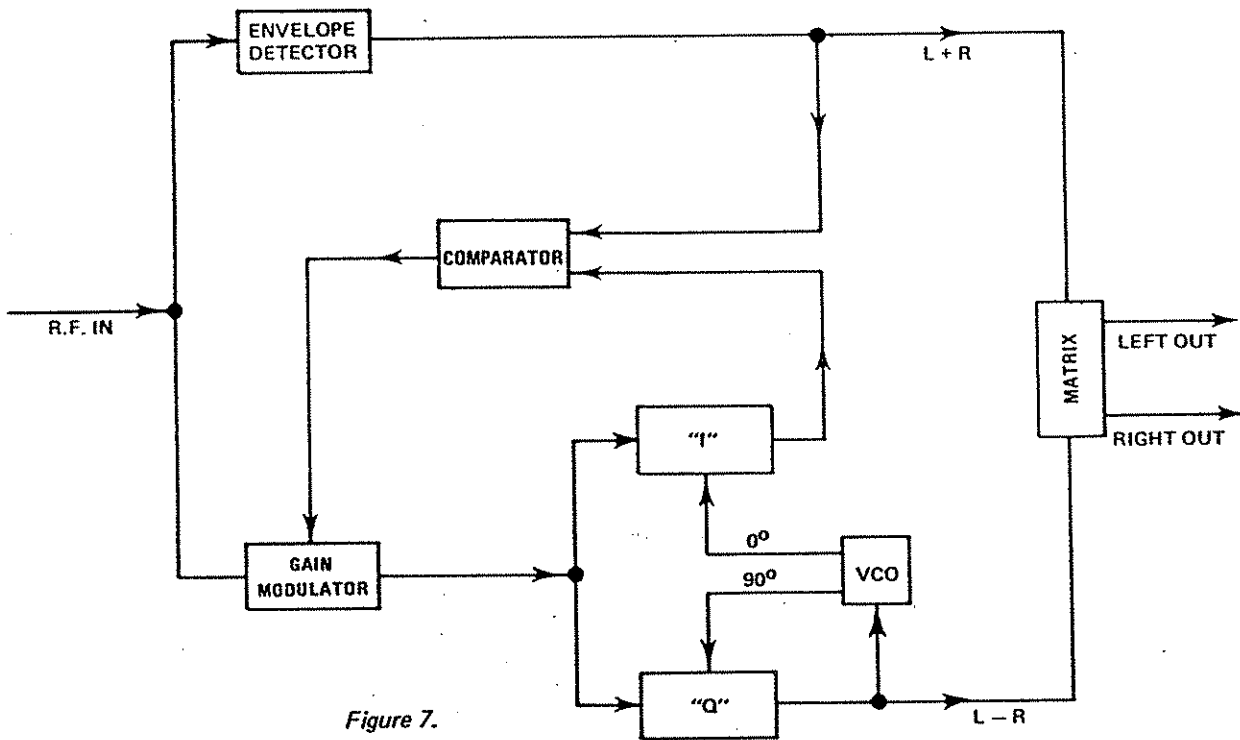

Figure 7.

### SYSTEM PERFORMANCE UNDER HEAVY MODULATION

There are many advantages of the Motorola system. One is its performance under 100 percent negative amplitude modulation conditions. When the carrier momentarily becomes small as in 100 percent negative modulation, the output of the envelope detector also becomes small. Because of the action of the comparator and gain modulator, the output of the "I" demodulator is small. Simultaneously, the output of the "Q" demodulator also is forced to be small. This means that there will be no large noise popping from the stereo channel under heavy negative amplitude modulations.

## APPENDIX

The following is a more detailed mathematical description of the C-Quam system.

### ENCODING COMPATIBLE QUADRATURE MODULATION

The existing RF oscillator of the transmitter is replaced by a substitute reference which has the angular modulation of a quadrature signal. The existing AM modulation technique is basically unchanged.

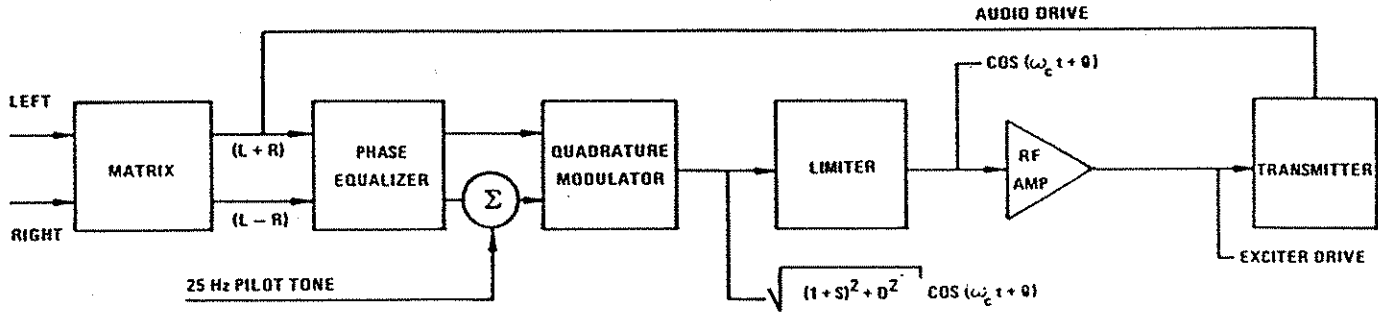

Note that the audio modulation sum information is unchanged from the monaural case and that a quadrature phase modulated RF drive is substituted for normal RF drive. The only other change is the presence of a Phase Equalizer to compensate for the differences in Amplitude/Phase relationships between the audio signal path and the RF path. This is necessary to maintain separation over a wide bandwidth.

Any suitable stereophonic audio processors may be used.

### DECODING THE COMPATIBLE QUADRATURE SIGNAL

The received compatible quadrature signal is a quadrature signal which has been modulated by the cosine of its relative phase angle information. It is also a compatible envelope detector signal. Therefore, sum information may be decoded with either an envelope detector or with a synchronous detector that is inversely modulated by the cosine of the phase modulation. Difference information may be decoded with a synchronous quadrature demodulator which is inversely modulated by the cosine of the phase modulation. In fact, there exists a multiplicity of decoding methods since:

$$L - R = (1 + S) \tan \theta = \frac{(1 + S) \sin \theta}{\cos \theta}$$

Where:  $S = L + R$



Hence, any sequence of operations which results in  $L - R$  is a valid decoding algorithm. Even non-PLL decoders are allowed since a discriminator, integrator, tangent function sequence results in  $L - R$ .

Motorola has evolved a first generation decoder design already discussed, which maximizes performance benefits at a minimum of cost and adjustments. Second and third generation decoders are under development which will further advance the state of the art.

**PRESENT C-QUAM RECEIVER DECODER IC**

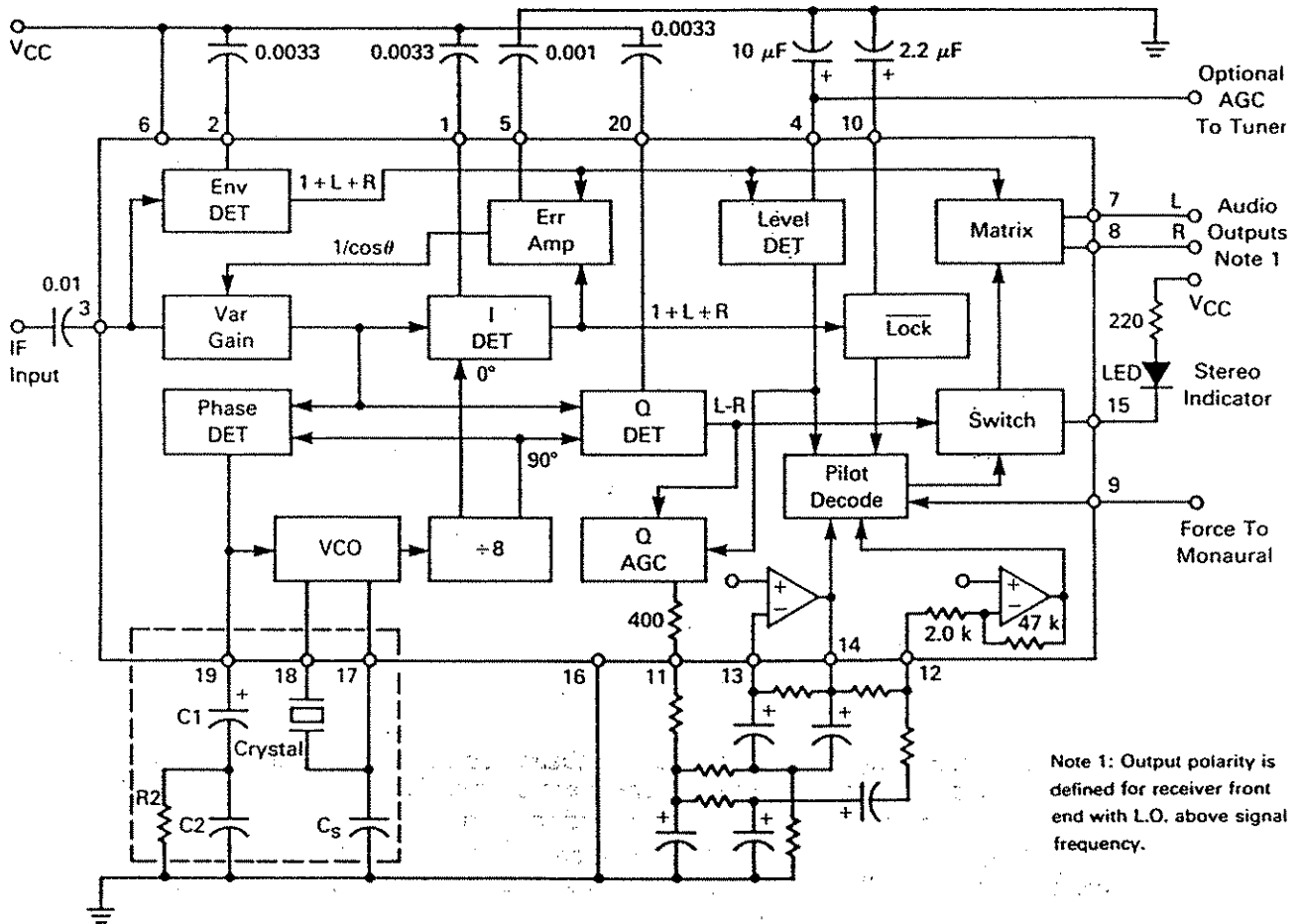

**SIGNAL EQUATION FOR MOTOROLA COMPATIBLE QUADRATURE SYSTEM**

$$E_c = A_c (1 + M_s (L(t) + R(t)) \cos \left[ \omega_c t + \tan^{-1} \left\{ \frac{M_d (L(t) - R(t)) + .05 \sin 50\pi t}{1 + M_s (L(t) + R(t))} \right\} \right]$$

where:  $M_s$  = index of modulation for sum information  
 $M_d$  = index of modulation for difference information  
 $.05 \sin 50\pi t$  = 25 Hz. pilot tone.

## INCIDENTAL PHASE MODULATION

Engineers and technicians associated with AM stereo constantly use the buzz letters "IPM." You may realize that these letters stand for (Incidental Phase Modulation) . . . but what is it? Simply defined, it is the un-intentional phase modulation of an RF carrier. An envelope modulated carrier (amplitude modulation) should not contain phase modulation. The normal envelope detector in the average AM receiver is oblivious to moderate amounts of phase modulation, as is most of the test and monitoring equipment in the average AM radio station. The addition of AM stereo (phase channel) to a transmitter makes it mandatory that IPM be reduced to an absolute minimum. That phase channel will now be used to transmit program material, and the incidental (un-intentional) modulation must be removed. Think of IPM as noise, hum or undesired sound. If the IPM in a transmitter is down 20dB, THEN YOUR STEREO NOISE FLOOR IS ONLY -20dB. The maximum separation of your stereo signal, anywhere within the audio spectrum, is therefore limited to 20dB!

The causes of IPM are varied, and some can be elusive. Transmitter final amplifier stages that are not completely neutralized contribute greatly to the cause; whereby, if a stage is "sliding around" looking for a different frequency to operate on it can generate considerable IPM. Driver stages can sometimes benefit from neutralization. Low power driver stages are often best neutralized by using Bruene, or bridge, neutralization. "Ageing" low voltage power supply filter capacitors can suffer from reduced capacity causing phase hum or IPM. Drive regulator circuitry and/or general lead dress in some transmitters can cause phase hum and noise. Radiated RF that is picked up on audio cables and fed back into transmitters causes IPM.

If a station does not have an AM stereo monitor or a spectrum analyzer, it is difficult to undertake an IPM reduction project. A narrow band AM stereo receiver can be a helpful aid in evaluating IPM and other nonlinearities occurring in an AM transmitter. Connect one audio channel of this receiver to the "X" input of your scope and the other audio channel to the "Y" input. Left channel out is normally used for vertical scope drive and right channel out is used for horizontal scope drive. Single tone amplitude modulation of the transmitter should produce a diagonal straight line on the scope — any deviation from a straight line represents non-linearity of some sort; distortion, IPM, etc. Shown in the installation section "A" of this manual are drawings depicting several IPM conditions as they would be displayed on a scope, plus additional information and measuring procedures.